

CAUTION THE INFORMATION ON THIS DRAWING IS THE PROPERTY OF BHARAT HEAVY ELECTRICALS LTD. IT MUST NOT BE USED DIRECTLY OR INDIRECTLY IN ANY WAY DETRIMENTAL TO THE INTEREST OF THE COMPANY.

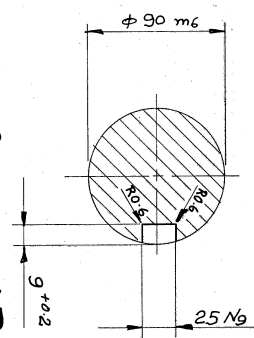

SECTION-AB
SCALE:- 1:2.5

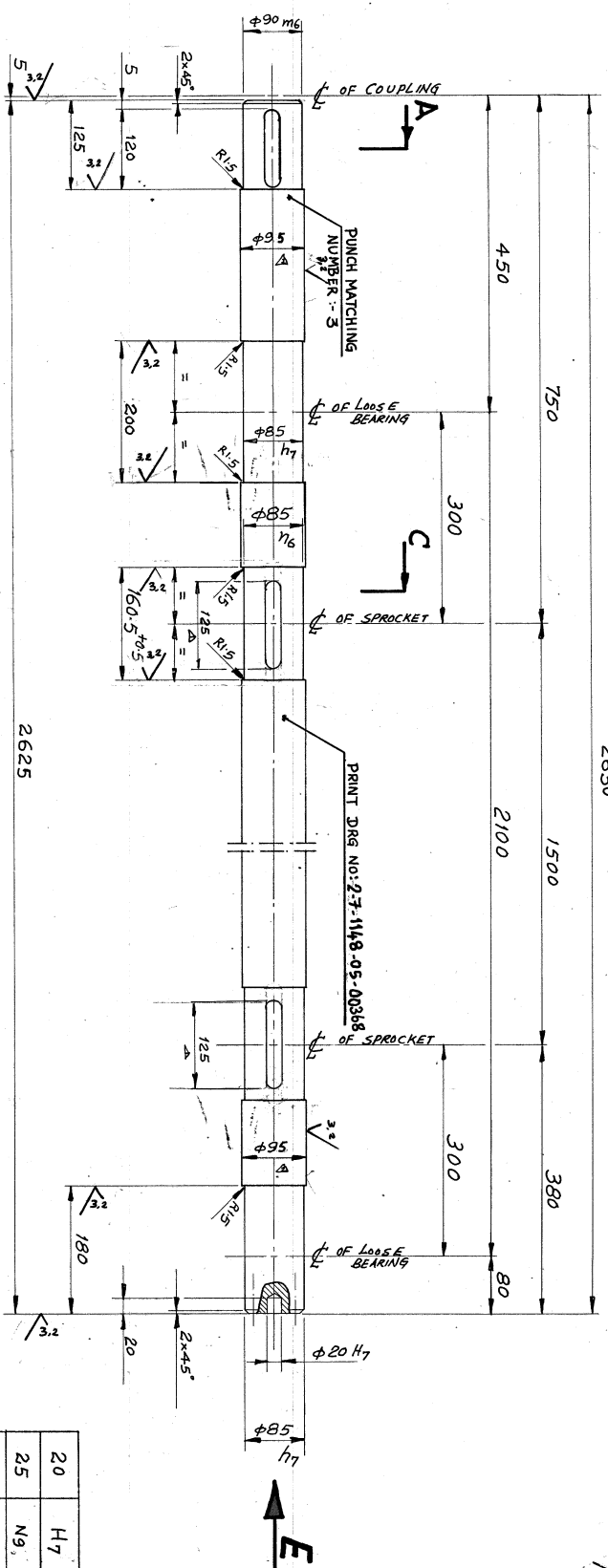
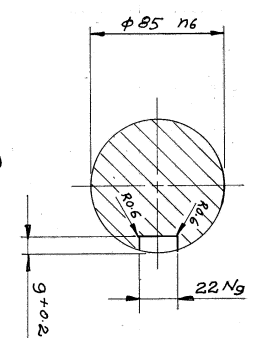

SECTION-CD
SCALE:- 1:2.5

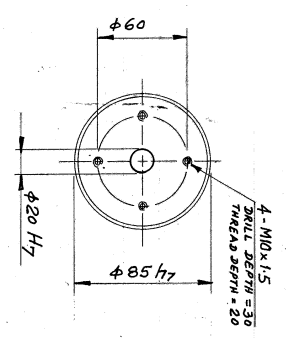

VIEW-E
SCALE:- 1:2.5

NOMINAL SIZE	TOLERANCE FIELD	DEVIATIONS
20	H7	+0.021
25	N9	0
22	N9	-0.052
90	M6	+0.035
85	N6	+0.045
85	N6	+0.023
85	h7	0
		-0.035

REV	DATE	ALT'D	BY	CHK'D	DATE	ALTERED	BY	CHK'D
02	4.8.95							

MATL. SPECN. A & C & B
15:1875 WAS
BWC & - 45.

		Bharat Heavy Electricals Ltd. SEAMLESS STEEL TUBE PLANT TRUCHIRAPALLI-620 014	
DEPT. CODE	SCALE	WEIGHT (kg)	REF TO REV./OLD DRG
C/M/F	1:5	132	SS7P-171-510
DESCRIPTION	DRAWING NO.	MATL. CODE	UNIT WT
SHAFT-IV	45C6 15.1875		
TITLE	DRAWING NO.	DEN	DATE
	23-1148-00-00368	SRK	23/11
		CHK	
		APP	
		REV	
		NO OF	
		ITEMS	

FIRST ANGLE PROJECTION (ALL DIMENSIONS IN MILLIMETRES)

1.6 / 3.2

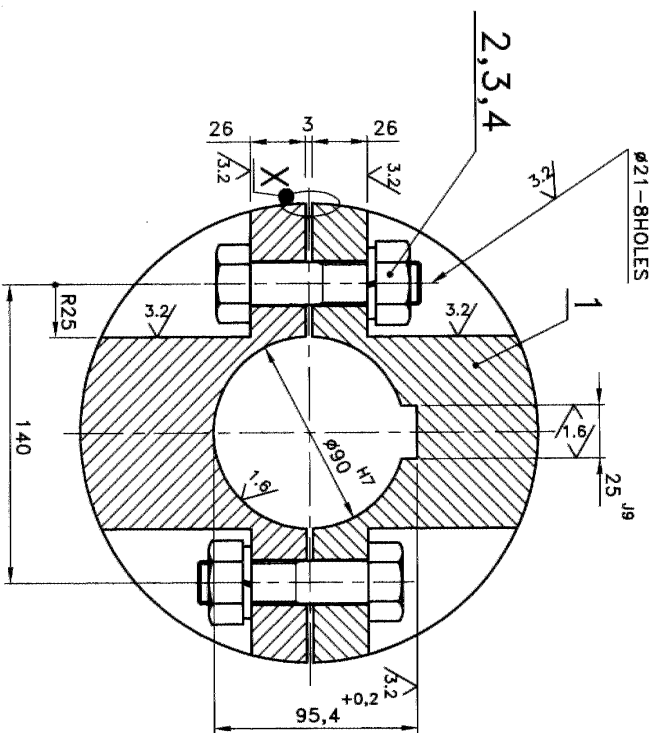
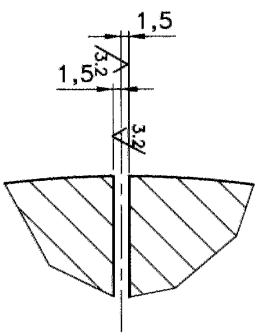
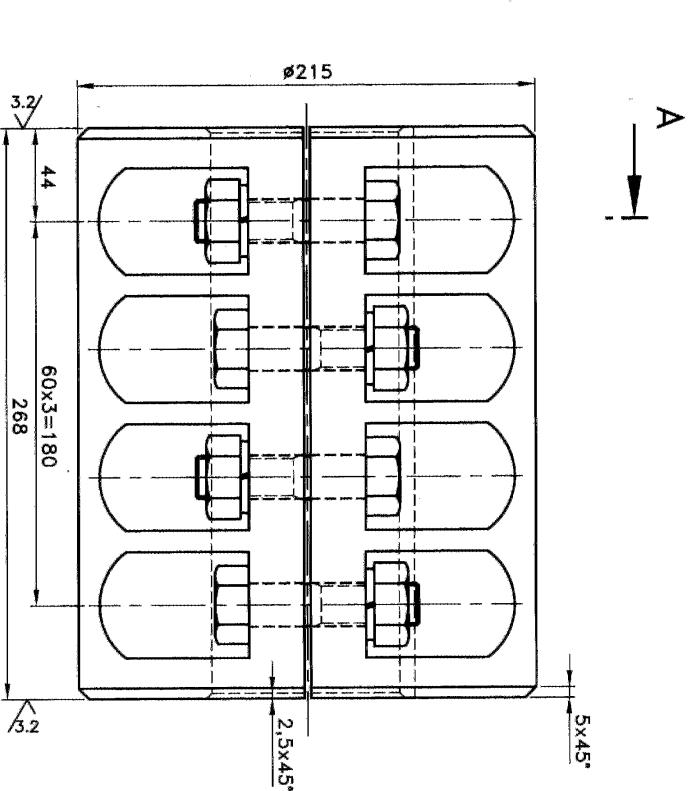

$\phi 90 H7$	+0,040
25 J9	+0,031 -0,031

$\sim \sqrt{1.9}, \sqrt{3.2}$

ALL DIMENSIONS ARE IN MILLIMETERS

ITEM NO	DESCRIPTION	DRAWING NO	MATL CODE	MATL SPEC	UNIT WT	QTY
1	$\phi 220 \times 275L$		CAST STEEL	Gr.230-450N IS:1030	1	64,0
2	HEX. BOLT M20x80L				8	0,259
3	HEX. NUT M20				8	0,063
4	SPRING WASHER B20				8	0,015

EQPT: T.F MANDREL BAR EXTRACTOR TO WBF

Bharat Heavy Electricals Ltd
 SEAMLESS STEEL TUBE PLANT
 TRUCHIRAPALLI - 620014

DRN	NAME	SIGNATURE	DATE
SSN KUMAR			11.7.98
AROCHKIAM A			16.7.98
SHANNUGASUNDARAM			16.07.98

REV	DATE	ALTERED :
01		CHECKED :
		APPROVED :
ZONE		

DEPT	GRADE OF	SCALE	WEIGHT (kg)
MPG	UNTL. DIM	1:2.5	67,0
C/M/F			

TITLE	CARD CODE	DRAWING NO :	REV
SPLIT MUFF COUPLING	U 01	3-7-1148-00-04211	00
CROSS TRANSFER ASSY			