



BHARAT HEAVY ELECTRICALS LIMITED

(A Government of India Undertaking)
HIGH PRESSURE BOILER PLANT
PURCHASE DEPARTMENT - FOSSIL BOILERS
THIRUCHIRAPALLI - 620014
TAMILNADU (INDIA)

Page
1/2

PHONE :2577419
GRAMS : BHARATELEC
FAX NO: 2520719
E-mail: cmuthuvel@bheltry.co.in
Web:

429-002/A

	Enquiry No 2001600131 - 73	Enquiry Date 16.03.2016	Due Date for Quotation 24.03.2016
<p>Please quote Enquiry No, Date and due date in all correspondences. This is only a request for quotation and not an order. Bid should be submitted in two parts. 1.Techno-commercial bid (Part-I) and 2.Price bid(Part-II) in a separate sealed cover and both covers must be placed in a third cover and sealed. Our Enquiry No., Enq. date & Enq. Due date must be written on all three covers.</p>			

Item	Description	Unit	Quantity	Delivery Quantity	Schedule Date
10	PANAMA CAPS	NO	210.000	210.00	30.04.16
20	Panama Caps	NO	18.000	18.00	30.04.16
30	Panama Cap with BHEL Emblem	NO	6.000	6.00	30.04.16
40	PANAMA CAP WITH BHEL EMBLEM PANAMA CAP DRG.ENCLOSED (DRG.NO. M&S-PD-15-028)	NO	500.000	500.00	30.04.16
50	PANAMA CAP WITH BHEL EMBLEM PANAMA CAP WITH BHEL EMBLEM	NO	1412.000	1,412.00	15.04.16
60	PANAMA CAP (White) WITH BHEL LOGO	NO	72.000	72.00	26.03.16
70	WHITE PANAMA CAP WHITE PANAMA CAP FOR HRDC EMPLOYEES USE	NO	15.000	15.00	30.04.16

General Note:

- 1.ENQUIRY CONDITION ENCLOSED
- 2.THIS TENDER IS AN EXCLUSIVE TENDER FOR MSE VENDORS ONLY.
2.OFFERS FROM Non-MSE VENDORS WILL NOT BE CONSIDERED AGAINST THIS ENQUIRY.
3. SAMPLE SHOULD BE SUBMITTED ALONG WITH TECHNICAL BID.

All the tenders may be addressed to the following address:

**The Tender Opening Cell / MM
Room No: 26, Building 24, Ground Floor
Bharat Heavy Electricals Limited
TIRUCHIRAPALLI 620014**

In case personal delivery of the offer, it shall be dropped into the respective box kept in Room No: 26, after duly entering the data in the system.

Offers will be accepted only up to 14.00 Hrs on the due date. Therefore, vendors shall ensure to submit the offers well before this time. All due date extension requirements should be addressed to the respective Purchase mail IDs. All the due date extension requests from vendors will be considered only up to 48 hours before the due date and time.

The offers should reach us 30 minutes before the time of opening of tenders.
The offers will be opened at 14.30 hrs on the due date of tender in the presence of tenderers who have submitted their offer and who may like to be present for the tender opening.Late and delayed offers are liable to be rejected.

Yours faithfully,
For **BHARAT HEAVY ELECTRICALS LIMITED**

MANAGER / PURCHASE
(FOSSIL BOILERS)
Yours faithfully,



BHARAT HEAVY ELECTRICALS LIMITED

(A Government of India Undertaking)
HIGH PRESSURE BOILER PLANT
PURCHASE DEPARTMENT - FOSSIL BOILERS
THIRUCHIRAPALLI - 620014
TAMILNADU (INDIA)

PHONE :2577419
GRAMS : BHARATELEC
FAX NO: 2520719
E-mail: cmuthuvel@bheltry.co.in
Web:

Page
2/2

2001600131 / 16.03.2016

23505

Vendors are requested to avoid submission of offers through e mail / fax. In case of any unavoidable situation, offers shall be sent through e mail to the following mail ID only tender_cell@bheltry.co.in.

As tenders are being opened by Common Tender Opening Cell, offer covers should be sealed with tenderer's distinctive seal and super scribed with correct Tender No. item of supply and due date of opening.

The offers will be opened at 14.30 hrs on the due date of the tender in the presence of tenderers who have submitted their offer and who may like to be present for the tender opening. Late and delayed offers are liable to be rejected.

The bidder along with its associate/ collaborators/ sub-contractors/ sub-vendors/ consultants/ service providers shall strictly adhere to BHEL fraud prevention policy displayed on BHEL website <http://www.bhel.com> and shall immediately bring to the notice of BHEL management about any fraud or suspected fraud as soon as it comes to their notice.

Enclosures:

"LD clause has to be confirmed without fail."

The offers should reach us 30 minutes before the time of opening of tenders.
The offers will be opened at 14.30 hrs on the due date of tender in the presence of tenderers who have submitted their offer and who may like to be present for the tender opening. Late and delayed offers are liable to be rejected.

Yours faithfully,
For BHARAT HEAVY ELECTRICALS LIMITED

MANAGER / PURCHASE
(FOSSIL BOILERS)
Yours faithfully,

M&S-PD-15-028

DRAWING NO:

ALL DIMENSIONS ARE IN MILLIMETRES

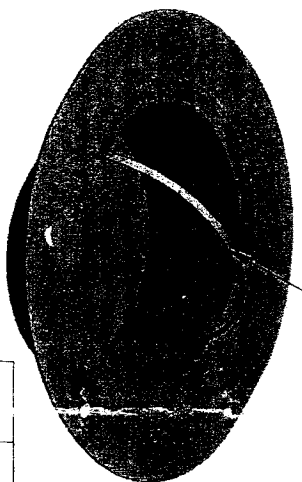
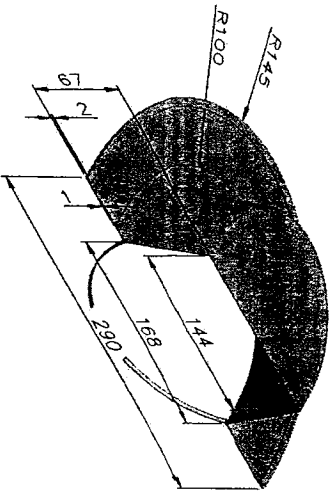

ELASTIC BELT

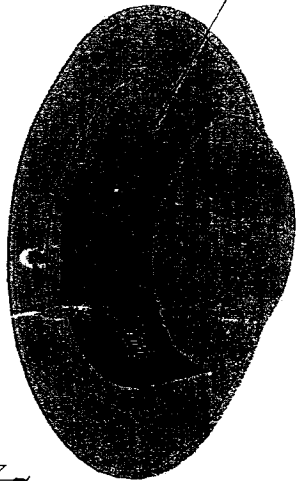

AIR HOLE

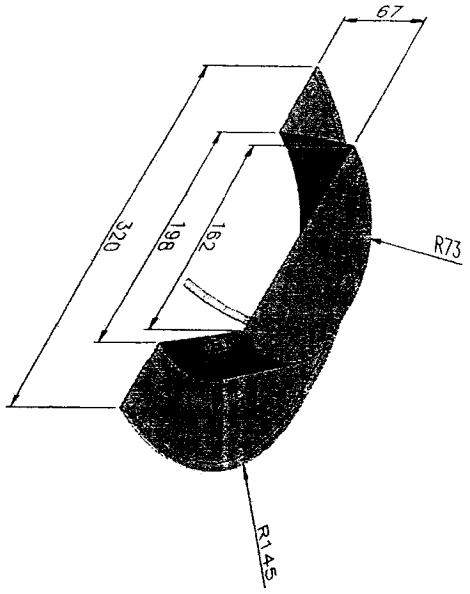

CAUTION: THE INFORMATION ON THIS DOCUMENT IS THE PROPERTY OF BHARAT HEAVY ELECTRICALS LIMITED. IT MUST NOT BE USED DIRECTLY OR INDIRECTLY IN ANY WAY DETRIMENTAL TO THE INTEREST OF THE COMPANY.

REV	DATE	ALTERED	CHECKED	APPROVED	ZONE

DEPT M&S		GRADE OR UNTOL. DIM φ / M / #		SCALE		WEIGHT (KG)		CARD CODE U 01		DRAWING NO : M&S-PD-15-028		REV 00	
2597		IS:2102		1:1						PANAMA CAP (PR 110314932)			
Bharat Heavy Electricals Ltd HIGH PRESSURE BOILER PLANT TIRUCHIRAPALLI - 620014													
ITEM NO	DESCRIPTION	DRAWING NO	MATL SPEC	MATL CODE	UNIT WT	QTY	NAME		SIGNATURE		DATE		
							DRN	T. BALAKRISHNAN				27.03.15	
							CHD	R. RAMAKRISHNAN				27.03.15	
							APPR	G. THAKRABAIAN				28.03.15	
EOP: -		REF TO ASSY DWG NO		REF TO OLD DWG NO									

[Handwritten signature]

A3-SIZE

BHARAT HEAVY ELECTRICALS LIMITED

(A GOVT. OF INDIA UNDERTAKING)

HIGH PRESSURE BOILER PLANT

TIRUCHIRAPPALLI-620 014

TERMS AND CONDITIONS OF THE ENQUIRY (TWO PART BID)

1. The tender will be operated on two part bid basis i.e. (I). *Techno-Commercial Bid* & (II). *Price Bid*.
2. **Techno-Commercial Bid:** Containing Technical details, specifications, commercial terms and conditions like percentage of P&F charges, Freight & Insurance, ED WITH CESS, Taxes (BHEL will not provide "C" form for Non-Production Items), delivery terms, delivery schedule, validity of offer, payment terms (except price details), acceptance for LD clause, etc. as per ANNEXURE-A (submitted in your company letter head) shall be put in a cover (1) and super scribed as "Techno-Commercial Bid" for Enquiry No:Dt:Due Dt.:
3. **Price Bid:** Containing the price details shall be put in a separate cover (2) and superscribed as "Price Bid" for Enquiry No:Dt.:Due Dt.: as per ANNEXURE -B (submitted in your company letter head)
4. You are requested to put the above two envelopes (Techno-Commercial Bid & Price Bid) inside a separate larger sealed envelope and this envelope shall be super scribed as "Techno-Commercial Bid and Price Bid" for Enquiry No:Dt.:Due Dt.:

Your Quotations should be sent to:

*Tender opening cell/ MM,
Room No.26,
24 Building (Ground Floor),
Bharat Heavy Electricals Limited,
Tiruchirappalli, - 620 014,
TamilNadu.*

5. Tender should not be addressed to any individual's name but only by designation.
 6. Tenders should be free from CORRECTION AND ERASURES. Corrections if any must be attested; all amounts shall be indicated both in words as well as in figures. Where there is difference between amount quoted in words and figures, amount quoted in words shall only be considered.
 7. Please submit point wise compliance to our specifications, terms and conditions. Otherwise it will be presumed that you are accepting BHEL's terms and conditions.
 8. Offer/s received after *due date* and time: 02:00 pm will not be considered under any circumstances.
 9. Validity of quoted rates should be maintained for 90 days from the date of Tender opening for ordering (Technical Bid). The quoted/Finalized rates shall be Firm till completion of the supplies.
 10. The rates are to be quoted on F.O.R. destination basis (Inclusive of Packing, Forwarding, and Freight and Transit Insurance charges to supplier account). All the items should be supplied at our stores, BHEL / TRICHY-14 at your own cost. Offers with any other delivery conditions will be rejected.
- IMPORTANT NOTE:** (I) *Delivery condition like Ex-works / Ex-godown / Transportation of materials through transport carriers from your works up to the transport carrier's office at Tiruchy and taking delivery of goods by BHEL from such office of transport carriers is not acceptable to us)*
11. Unloading at BHEL Site has to be done by the suppliers and BHEL will not be in a position to provide any handling/unloading facilities.
 12. **Payment Terms (Indigenous)**

Payment term is 100% direct payment after 45 days from the date of receipt and acceptance of materials.

Any deviation in the above payment term will attract loading as mentioned below.

"Base rate of SBI (as applicable on the date of bid opening. Techno-commercial bid opening in case of two part bids) + 6% shall be considered for loading for the period of relaxation sought by bidders.

NOTE: 100% payment against dispatch document through bank / 90% payment against through document through bank + 10% payment after acceptance of materials / Cheque payment / payment against proforma invoice / advance payment / current cheque or post-dated cheque along with purchase order will not be accepted and those offers will not be considered.

13. Liquidated Damages / Penalty:-

Liquidated damages shall be 0.5% of the total order value per week or part thereof subject to a maximum of 10% of the total order value.

Any deviation from the above LD clause, loading will be applied to the extent to which it is not agreed by the bidder (at offered value).

14. If Guarantee / Warranty period is applicable as per tender specification, No deviation permitted and deviated offers are liable for rejection.

15. IMPORTANT NOTE: BHEL WILL CONSIDER THE RANKING AFTER THE LOADING IS APPLIED AS REFERRED ABOVE WHEREVER DEVIATIONS ARE OBSERVED.

16. No revision of prices will be entertained at any circumstances after tenders are opened.

17. If any sales tax is payable as extra to the quoted price it should be specifically stated in quotations along with CST & VAT Number failing which the purchaser will not be liable for payment of sales tax. Our TIN 33243560005 dt.01.01.2007 & CST no 239383 DT, 11.06.1991

18. On the due date of tender opening, only the technical bids will be opened. Technical bids will be evaluated by us and clarifications required, if any, will be called for from the bidders on technical and commercial points. The price bids of techno-commercially suitable bidders will be opened at a later date with prior intimation to respective suitable bidders.

19. Ranking L-1, L-2 etc. shall be done generally on each individual items for the techno-commercially acceptable offers on landed cost to BHEL, Trichy basis and BHEL reserves the right to place order for individual items with different vendors. At special circumstance ranking shall be done on compatible basis which will be indicated through Enquiry special instruction General Notes.

20. BHEL reserves the right to increase or decrease the tender quantity and split up the tender quantity among more than one vendor at the lowest acceptable price to BHEL and place order accordingly in any proportion at our own discretion.

21. Lowest price received against BHEL tenders need not be the technically acceptable one and in that case BHEL reserves the right not to consider the same. The purchaser shall be under no obligation to accept the lowest or any other tender and shall be entitled to accept or reject any tender in part or full without assigning any reason whatsoever.

22. BHEL reserves the right to negotiate or refloat the tender opened, if L1 price is not the lowest acceptable price to BHEL due to inter-alia other reasons.

23. PACKING AND MARKING: The supplier shall arrange for securely protecting and packing the stores to avoid loss or damages during transit.

24. RISK PURCHASE: Alternatively the purchaser at his option will be entitled to terminate the contract and to purchase elsewhere at the risk and cost of the seller either the whole of the goods or any part which the previous supplier has failed to deliver or dispatch within the time stipulated as aforesaid or if the same were not available, the best and the nearest available substitutes therefore. The new supplier shall be liable for any loss, which the purchaser may sustain by reason of such risk purchases in addition to penalty at the rate mentioned in our LD clause.

25. The Tender Due date falling on public holiday due to any circumstances, the tender will be opened on next working day.

26. PREFERENTIAL DELIVERY:(Applicable in the case of BHEL's Enquiry specifies Preferential Delivery in the Special Instructions) It should be noted if a contract is placed on a higher tendered as a result of this invitation to tender in preference to the lowest acceptable offer in consideration of the earlier delivery, the seller will be liable to pay to the purchaser the difference between the contract rate and that of the lowest acceptable tender on the basis of final price F.O.R destination, including all elements of freights, Sales tax, duties and other incidents, incidental in case of failure to complete supplies in terms of such contract within the date of delivery specified in the tender and incorporated in the contract, such difference amount in addition to penalty at the rate mentioned in our LD clause.

27. CENVAT CREDIT: If any Excise Duty is payable, the Chapter Head / Sub -head reference and the rate of the duty should be quoted. If the Tenderer is availing CENVAT credit for this input material, the effect of Performa credit should be passed on to the purchaser. Tenderer under "CENVAT" shall be preferred.

28. Any other conditions which might have been quoted by the seller and are in contravention to the terms prescribed in the order and which have not been specifically accepted by purchaser in written will not be applicable to the contract.

29. VENDORS CURRENTLY NOT REGISTERED WITH BHEL TRICHY & WISH TO PARTICIPATE TO IN THIS ENQUIRY SHOULD FURNISH THE FOLLOWING DOCUMENTARY PROOF / INFORMATION ALONG WITH OFFER, OTHERWISE YOUR OFFER WILL NOT BE CONSIDERED FOR EVALUATION.

- a) Copy of Registration certificate
- b) Banker's Information with copy of Bank Pass Book first Page.
- c) Complete postal address with Pin Code.
- d) Contact Person /s , Phone No, Mobile No, FAX No, Email ID etc.
- e) Copy of statutory documents – VAT / TIN / EXICISE REGISTRATION / SERVICE TAX REGISTRATION / CST REGISTRATION etc
- f) ISO certificate (if applicable)
- g) Copy Purchase Order & Experience certification as proof of supply of similar item to any Govt. Agencies / PSU / Organizations.
- h) Balance Sheet for last three financial years along with audit report is to be submitted.
- i) Partnership Deed if applicable.

30. This tender is exclusively for MSE vendors provided they have to submit the following documents:

- i. Attested copies of either EM II certificate having deemed validity (five years from the date of issue of acknowledgement in EM II) or,
- ii. Valid NSIC certificate or,
- iii. EM II certificate along with attested copy of CA (Format enclosed at Annexure-1 where deemed validity of EM II certificate of five years has expired) applicable for the relevant financial (latest audited).
Date to be reckoned for determining the deemed validity will be the date of technical bid submission. Non submission of such documents will lead to consideration of their bids at par with other bidders.
- iv. In case of any change in the MSE status of the bidder, it shall be the responsibility of the bidder to notify the change as a part of the bid document. If at a later date it comes to the knowledge of BHEL, that the change in the status has not been intimated by the bidder and the order is obtained under the premise of an MSE then BHEL would cancel the pending order against this tender and take necessary steps for suspension of the business dealing with the bidder as per the procurement policy of BHEL.

31. Offers from Non-MSE vendors will not be considered against this enquiry.

32. For verification of data submitted towards evaluation of bidder's capability, BHEL may decide to visit the bidder(s) works. Any fact found deviating from submitted data shall make the bidder liable to be disqualified.

33. In the event of more than one vendor becoming L1 for any of the Item / items, the enquiry quantity for those item / items will be shared equally among all the L1 vendors.

34. The correspondence between the bidder and BHEL through email is considered as valid document legally though not Signed. It is treated as valid confirmations made on behalf of the respective company and comes under the legal ambit of the business transaction and hence binding on both the parties.

35. Any corrigendum related to the enquiry will be hosted in the BHEL website only, Bidders should visit the website(s) to keep themselves updated.

36. The Enquiry Number and Due Date which is super scribed on the outer cover of "Techno-Commercial Bid and Price Bid" should be same as per our enquiry number and due date, otherwise BHEL will not be considered that offer for opening and further process.

37. Delivery goods/ items should be securely and suitably packed to avoid transit damages.

38. Vendor should furnish data as required in Annexure – C (Attached) with Signature & Seal.

A handwritten signature in black ink, appearing to be 'The' followed by a stylized flourish.

Certificate by Chartered Accountant on letter head

This is to Certify that M/S
(hereinafter referred to as 'company') having its registered office at
..... is registered under MSMED Act 2006, (Entrepreneur
Memorandum No (Part-II) dtd:.....
Category: (Micro/Small). (Copy enclosed).

Further verified from the Books of Accounts that the investment of the company as per the latest audited financial year as per MSMED Act 2006 is as follows:

1. **For Manufacturing Enterprises:** Investment in plant and machinery (i.e. original cost excluding land and building and the items specified by the Ministry of Small Scale Industries vide its notification No.S.O.1722(E) dated October 5, 2006 :
Rs.....Lacs
2. **For Service Enterprises:** Investment in equipment (original cost excluding land and building and furniture, fittings and other items not directly related to the service rendered or as may be notified under the MSMED Act, 2006:
Rs.....Lacs

(Strike off whichever is not applicable)

The above investment of Rs.....Lacs is within permissible limit of Rs.....Lacs forMicro / Small (Strike off which is not applicable) Category under MSMED Act 2006.

Or

The company has been graduated from its original category (Micro/ Small) (Strike off which is not applicable) and the date of graduation of such enterprise from its original category is (dd/mm/yyyy) which is within the period of 3 years from the date of graduation of such enterprise from its original category as notified vide S.O. No. 3322(E) dated 01.11.2013 published in the gazette notification dated 04.11.2013 by Ministry of MSME.

Date:

(Signature)

Name -

Membership number -

Seal of Chartered Accountant

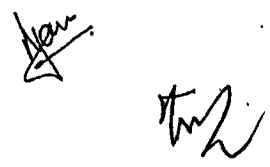

ANNEXURE -A

KINDLY SPECIFY ALL ENQ SL NOS AS PER BHEL ENQUIRY. (SUBMITTED IN COVER NO: 1)

ENQ SL NO	BHEL SPECIFICATIONS	YOUR SPECIFICATION	WHETHER QUOTED/ NOT QUOTED
10			

COMMERCIAL TERMS CONFIRMATION REQUIRED FROM THE SUPPLIERS (SUBMITTED IN COVER NO: 1)

SL NO	DESCRIPTION	BHEL REQUIREMENTS	SUPPLIER CONFIRMATION
1	VALIDITY	90 Days from Date of tender opening	Should be accepted by Vendor
2	DELIVERY REQUIREMENTS	FOR-DESTINATION BHEL STORES TRICHY -620014	Should be accepted by Vendor
3	PACKING & FORWARDING (Whether inclusive or extra) Clearly mention the percentage or amount.	SUPPLIER OPTION	INCLUDED / EXTRA INCASE OF EXTRA MENTION THE PERCENTAGE _____ OR AMONT _____
4	EXCISE DUTY WITH CESS (Whether inclusive (or) extra) Clearly mention the percentage (or) amount	SUPPLIER OPTION	INCLUDED / EXTRA INCASE OF EXTRA MENTION THE PERCENTAGE _____
5	VAT / CST clearly mention the percentage.	SUPPLIER OPTION	INCLUDED / EXTRA INCASE OF EXTRA MENTION THE PERCENTAGE _____
6	FREIGHT (Whether inclusive or extra) Clearly mention the percentage or amount.	SUPPLIER OPTION	INCLUDED / EXTRA INCASE OF EXTRA MENTION THE PERCENTAGE _____ OR AMONT _____
7	SERVICE TAX IF ANY FOR FREIGHT ELEMENT ONLY	SUPPLIER TO QUOTE	NOT APPLICABLE/INCLUDED / EXTRA INCASE OF EXTRA MENTION THE PERCENTAGE _____
8	Service Tax If any for Erection and commissioning	SUPPLIER TO QUOTE	NOT APPLICABLE/INCLUDED / EXTRA INCASE OF EXTRA MENTION THE PERCENTAGE _____
9	DEIVERY SCHEDULE	AS PER TENDER SCHEDULE	
10	PAYMENT TERMS	As per Clause 12 of Terms and Conditions of the Enquiry (Two Part Bid)	
11	LD CLAUSE	As per Clause 13 of Terms and Conditions of the Enquiry (Two Part Bid)	
12	CONTACT PERSON DETAILS	NAME: MOBILE NO: EMAIL :	
13	TEST CERTIFICATE	REQUIRED/ NOT-REQUIRED	Certificate should be produced
14	GUARANTEE / WARRANTY	REQUIRED / NOT-REQUIRED	Certificate should be produced
15	MSE STATUS	Should attach the documents called for in enquiry Terms & Conditions	

Vendors Seal & Signature



ANNEXURE -B

PRICE BID FORMAT OF ALL QUOTED ITEMS, IF ANY ITEM YOUR ARE NOT QUOTED SIMPLY YOU SHOULD MENTION AS "NOT QUOTED" AGAINST THAT ENQ SL NO. (SUBMITTED IN SEPARATE COVER NO: 2)

ENQ SL NO	BHEL SPECIFICATIONS	YOUR SPECIFICATION	SUPPLIER SHOULD BE QUOTOED EX-WORK BASIC PRICE ONLY IN RS (ALL OTHER TERMS ARE ALREADY QUOTED IN ANNEXURE -A)
10			

Vendors Seal & Signature

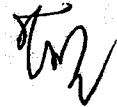

ANNEXURE - C

THE FOLLOWING DATA SHOULD BE FURNISHED BY NEW VENDOR

1. NAME & ADDRESS OF THE VENDOR :
2. CONTACT / COMMUNICATION DETAILS : PERSON:
LANDLINE & MOBILE NO:
FAX NO.:
EMAIL ID:
3. BUSINESS TYPE : MANUFACTURER / TRADER / AGENT
4. BUSINESS STATUS : MSE / NON-MSE (IN CASE OF MSE, NECESSARY DOCUMENTS SHOULD BE FURNISHED)
5. MSE TYPE : MICRO / SMALL
6. MSE OWNER CATEGORY : SC / ST (COMMUNITY CERTIFICATE SHOULD BE FURNISHED)
7. TYPE OF MSE FIRM : PROPRIETARY / PARTNERSHIP (IN CASE OF PARTNERSHIP FIRM, PERCENTAGE OF SHARE HELD SHOULD BE FURNISHED)
8. CST NO (DOC. PROOF SHOULD BE FURNISHED) :
9. VAT NO (DOC. PROOF SHOULD BE FURNISHED) :
10. EXCISE DUTY REGISTRATION NO. (DOC. PROOF SHOULD BE FURNISHED) :
11. PAN NO. :

(SIGNATURE & SEAL)

