



BHARAT HEAVY ELECTRICALS LIMITED

(A Government of India Undertaking)

HIGH PRESSURE BOILER PLANT
PURCHASE DEPARTMENT - FOSSIL BOILERS
THIRUCHIRAPALLI - 620014
TAMILNADU (INDIA)

Page
1/2

PHONE :2577629
GRAMS : BHARATELEC
FAX NO: 2520719
E-mail: srchandran@bheltry.co.in
Web:

429-002/A

	Enquiry No 2661400753 - 55	Enquiry Date 15.10.2014	Due Date for Quotation 10.11.2014
Please quote Enquiry No, Date and due date in all correspondences. This is only a request for quotation and not an order			

Item	Description	Unit	Quantity	Delivery Quantity	Schedule Date
10	7502A4000100 LT WHEEL AS PER DRG. NO. 3-M-02A40-15316 (SUPERCEDED BY DRG.NO. 4M02A4028540) Note for all items: For all the wheels Supplier shall provide the certificates from government approved lab for material compositions and hardness values. The hardness values shall be noted down after heat treatment only. VENDOR QUALIFYING CRITERIA FOR ALL ITEMS: (1) ONLY THOSE VENDORS WITH MINIMUM 3 YEARS EXPERIENCE IN SUPPLYING WHEELS FOR CRANES ARE ELIGIBLE TO PARTICIPATE IN THIS TENDOR. (2) MINIMUM 5 NOS. PO COPIES SHALL BE SUBMITTED AS PROOF FOR EXPERIENCE IN CRANE WHEEL SUPPLY. (3) Company profile details has to be provided along with offer. (4) BHEL reserves the right to visit the vendor's works for verifying the manufacturing facilities and any other credential furnished by the vendor. In case the information furnished with the offers found to be false / incorrect, the offer shall be rejected.	NO	3.000	3.00	31.12.14
20	7502A5600100 LT WHEEL AS PER DRG. NO. 3-M-02A56-15314 (SUPERCEDED BY DRG.NO. 4M02A5629292)	NO	2.000	2.00	31.12.14
30	7502A4000300 LT WHEEL AS PER BHEL DRG NO. 3-M-02A40-15297-01	NO	4.000	4.00	31.12.14
40	7502A4000400 CT WHEEL AS PER BHEL DRG NO. 3-M-02A-40-15299-01	NO	2.000	2.00	31.12.14
50	7502A2300100 LT WHEEL AS PER DRG. NO.	NO	4.000	4.00	31.12.14

The offers should reach us 30 minutes before the time of opening of tenders.
The offers will be opened at 14.30 hrs on the due date of tender in the presence of tenderers who have submitted their offer and who may like to be present for the tender opening.Late and delayed offers are liable to be rejected.

Yours faithfully,
For **BHARAT HEAVY ELECTRICALS LIMITED**

MANAGER / PURCHASE
(FOSSIL BOILERS)
Yours faithfully,



BHARAT HEAVY ELECTRICALS LIMITED

(A Government of India Undertaking)
HIGH PRESSURE BOILER PLANT
PURCHASE DEPARTMENT - FOSSIL BOILERS
THIRUCHIRAPALLI - 620014
TAMILNADU (INDIA)

Page
2/2
PHONE :2577629
GRAMS : BHARATELEC
FAX NO: 2520719
E-mail: srchandran@bheltry.co.in
Web:

2661400753 / 15.10.2014

3-M-02A23-15307 (SUPERCEDED BY DRG.NO.
3M02A2309680)

60	7502A4500100	NO	4.000	4.00	31.12.14
	LT WHEEL AS PER DRG NO. 3-M-02A45-15315 (SUPERCEDED BY DRG.NO. 4M02A4528383)				

General Note:

GENERAL NOTE:PLEASE SUBMIT YOUR OFFER IN "TWO PART BID SYSTEM" AS PER THE ANNEXURES ENCLOSED.

ENCLOSURES:ANNEXURE II,III,IV,V,VI,VII.

Enclosures:

"LD clause has to be confirmed without fail."

The offers should reach us 30 minutes before the time of opening of tenders.
The offers will be opened at 14.30 hrs on the due date of tender in the presence of tenderers who have submitted their offer and who may like to be present for the tender opening.Late and delayed offers are liable to be rejected.

Yours faithfully,
For BHARAT HEAVY ELECTRICALS LIMITED

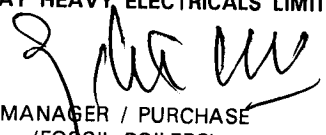
MANAGER / PURCHASE
(FOSSIL BOILERS)
Yours faithfully,

CAPITAL PURCHASE
COMMERCIAL TERMS AND CONDITIONS

1.0 QUOTATIONS

The Bidders shall submit the offer in **TWO INNER ENVELOPES** as indicated below which shall be sealed in one outer envelope.

Envelope I This sealed envelope should contain all the copies of technical bid together with un-priced commercial bid & annexure III. This envelope should be clearly marked '**Part I - Technical and commercial bid**',

Indicating Enquiry No., Due Date and Address & Reference of the Bidder.

Envelope II This sealed envelope should contain **price as per Annexure-IV format**. This envelope should be clearly marked "**Part II - Price bid**", indicating **Enquiry No., Due Date and Address & Reference of the Bidder**.

Both the envelopes (Part I & II) shall be put in one cover (**Envelope III**), duly sealed, superscribing as Part I and Part II of Enquiry No., due date of opening and the address and reference of the Bidder

The above offer should reach this office on or before the due date by 14.00 hours (IST). Late offers will not be considered.

Tender should not be addressed to any individual's name but only by designation to

**SENIOR MANAGER /PURCHASE/ CP & SP/ MM / MFG
 BHARAT HEAVY ELECTRICALS LIMITED
 HIGH PRESSURE BOILER PLANT
 TIRUCHIRAPALLI - 620 014
 TAMIL NADU**

Tenders should be free from **CORRECTION AND ERASURES**, Corrections if any, must be attested. All Amounts shall be indicated both in words as well as in figures. Where there is difference between amount quoted in words and figures, amount quoted in words shall prevail.

Offers should be in **ENGLISH** and accompanied by detailed technical literature, catalogue and detailed dimensional drawings in **ENGLISH** or otherwise, the offers will not be considered.

2.0 OPENING OF TENDERS

The Part I - Technical & commercial bid alone would be opened on the Tender opening date.

The Part II - Price bid of technically suitable Bidders alone would be opened. The Technically Suitable Bidders would be informed about the tender opening date through e-mail.

Clarifications if any required by BHEL for Technical evaluation **would be** sought from Bidders before opening of Part II - price bid

For any queries clarifications the bidders may contact us through our FAX NO. +91 431 2520719 or through e-mail <mmcpmfg1@bheltry.co.in >&< chells@bheltry.co.in>

Annexure For Techno Commercial Bid

Check List - to be filled and submitted along with Technical Bid

BHEL Commercial Terms and Conditions for Indigenous Supplies		Vendor's Confirmation / Comments
Technical confirmation to BHEL's Specification as called for in BHEL Format shall be furnished. If needed additional sheets shall be used.		
Prices shall be quoted item wise only as per the model format enclosed		
Prices shall be quoted on " FIRM PRICE " basis only The prices should be only on F.O.R / Despatching station basis with Packing & Forwarding charges if any. Applicable % of ED & Sales Tax, Freight & Insurance, Installation & Commissioning Charges should be clearly Indicated		
Validity of offer shall be for a minimum period of 120 days from the date of Tender opening		
Delivery period from the date of Letter of Intent / Purchase order shall be clearly mentioned in the offer		
Liquidated damages @ '0.5% per week subject to a maximum of 10% of the order value shall be applicable for delay in deliveries For Details Refer Annexure- v		
Following Risk Purchase clause shall be applicable The purchaser at his option will be entitled to terminate the contract and to purchase elsewhere at the risk and cost of the seller either the whole of the goods or any part which the supplier has failed to deliver or dispatch within the time stipulated or if the same were not available, the best and the nearest available substitute therefore The supplier shall be liable for any loss which the Purchaser may sustain by reason of such risk purchases		
Payment term for supply portion: Payment term is 100% direct payment after 45 days from the date of receipt and acceptance of materials For details Refer Annexure- v		
Erection / commissioning: (if applicable only) Erection / commissioning charges if any has been mentioned in the offer or else confirmation that Erection /commissioning shall be done at free of cost is available in the offer,		
The equipment shall be guaranteed for a period of 12 months from the date of commissioning		
Final inspection and acceptance of equipment will be after installation at BHEL, Trichy		
The vendor shall provide necessary drawings, Test Certificates and Operating Maintenance Manuals etc., as called for in the Technical Specification, in the required number of copies at no extra cost		
Any warranty replacement during warranty period shall be supplied free of charge on FOR BHEL, Trichy basis.		
Offers should be submitted only in sealed cover super-scribing clearly the Enquiry reference and due date.		
% of Excise Duty with cess		
% of TAX (CST/VAT)-(INGST with FORM-17 or CST with C-FORM)		
Packing & Forwarding Charges (if any in % only)		
Percentage of Freight& transit insurance charges, if any Freight charges from Dispatching station to BHEL, Tiruchirappalli • Supplier should quote for F.O.R-BHEL Trichy Stores.		
As per Commercial terms and conditions, acceptance for participation in Reverse auction (RA).Yes/No to be indicated		
Name of the person for participating reverse auction		
Land Line Number		
Fax Number		
Mobile Number		
E-mail ID		

NOTE:-

- It is confirmed that all the terms and conditions stipulated in the Enquiry have been fully understood by us and all clarifications & details have been obtained.
- Your offer should be indicating applicable if any P&F Charges, % of ED, Sales Tax -CST or VAT, Service Tax), Freight, Insurance and Installation and Commissioning Charges etc., as per our Price Format
- Your specific acceptance to our Payment terms, LD & Risk Purchase Clause are essential for consideration of your offer. Other wise your offer is liable for rejection.
- No row shall be left blank. Please indicate NA, in case the item is "not applicable"

Payment Term (Indigenous)	
If materials are receivable at Stores/Trichy <u>without</u> PBG	Payment term is 100% direct payment after 45 days from the date of receipt and acceptance of materials.
If materials are receivable at Stores/Trichy <u>with</u> PBG	Payment term is 100% direct payment after 45 days from the date of receipt and acceptance of materials and against 10% PBG valid for the warranty period.
Any deviation in the above payment term will attract loading as mentioned below. “Base rate of SBI (as applicable on the date of bid opening. Techno-commercial bid opening in case of two part bids) + 6% shall be considered for loading for the period of relaxation sought by bidders.	

Payment through Bank is not preferred. In case of Payment through Bank is opted by Supplier, BHEL prefers documents submission through bank with copy of LR and door delivery of Goods to Site/Stores with Consignee copy attached. In this case Loading will be 3% on the offered value.

Offers of indigenous Suppliers with payment terms as LC/Advance Payment are liable for rejection.

Liquidated Damages / Penalty -

Liquidated damages shall be 0.5% of the total order value per week or part thereof subject to a maximum of 10% of the total order value.

For staggered delivery schedule, LD shall be 0.5% of the undelivered portion per week of the delay or part thereof subject to a maximum of 10% of the total order value.

Any deviation from the above LD clause, loading will be applied to the extent to which it is not agreed by the bidder (at offered value).

Guarantee / Warranty Period – (if applicable)

Normally No deviation permitted and the deviated offers are liable for rejection.

Ranking-

BHEL will consider the ranking after the loading is applied as referred above wherever deviations are observed.

Performance Bank Guarantee – (if applicable)

Normally No deviation permitted and the deviated offers are liable for rejection.

NOTE:-

1. If the due date of tender opening happens to be a holiday, the tenders will be opened on the next working day.
2. BHEL reserves the right to go for a reverse auction (RA) instead of opening the submitted sealed bid which will be decided after technical evaluation. Information and general terms and conditions covering RA are given in commercial terms and conditions.
3. Corrigendum if any, with respect to this tender will be hosted only in the website <http://www.bhel.com> or <http://tenders.gov.in>. You are requested to visit the website regularly for updates.

Special Provisions for Micro and Small Enterprises (MSE)

1. 20% of the tendered quantity is earmarked for MSE suppliers in this tender.
2. Out of the 20% tendered quantity reserved for MSE suppliers, 4% shall be earmarked for procurement from MSE owned by SC/ST entrepreneurs.
3. In case MSE vendor participating in the tender quotes within the price band of L1+15%, they will be allowed to supply the portion of the requirement subject to acceptance of L1 price by MSE vendor. In case of more than one such MSE, the supply shall be shared proportionately.
4. "MSE suppliers can avail the intended benefits only if they submit along with the offer, attested copies of either EM II certificate having deemed validity (five years from the date of issue of acknowledgement in EM-II) or valid NSIC certificate or EM II certificate along with attested copy of a CA certificate (Format enclosed at Annexure -VII where deemed validity of EM II certificate of five Years has expired) applicable for the relevant financial year (latest audited). Date to be reckoned for determining the deemed validity will be the date of bid opening (Part I in case of two part bid). Non submission of such documents will lead to consideration of their bid at par with other bidders. No benefit shall be applicable for this enquiry if any deficiency in the above required documents are not submitted before price bid opening. If the tender is to be submitted through e-procurement portal, then the above required documents are to be uploaded on the portal. Documents should be notarized or attested by a Gazetted officer."

Certificate by Chartered Accountant on letter head

This is to Certify that MIS
(hereinafter referred to as 'company') having its registered office at
..... is registered under MSMED Act 2006, (Entrepreneur
Memorandum No (Part—II) dtd.
Category:,....., (Micro/Small)). (Copy enclosed).

Further verified from the Books of Accounts that the investment of the company
as per the latest audited financial year as per MSMED Act 2006 is as follows:

For Manufacturing enterprises: Investment in plant and machinery (i.e original cost
excluding land and building and the items specified by the Ministry of Small Scale Industries vide its
notification No.S.O,1722(E) dated October 6. 2006:

Rs... ..Lacs

2. **For Service Enterprises:** Investment in equipment (original cost excluding land and building and
furniture, fittings and other items not directly related to the service rendered Or as may be notified under the
MSMED Act, 2006.

Rs..... Lacs

(Strike off whichever is not applicable)

The above investment of RsLacs is within permissible limit of
Rs..... Lacs for Micro I Small (Strike off which is not applicable)
Category under MSMED Act 2006.

Or

The company has been graduated from its original category (Micro/ Small) (Strike off which is not
applicable) and the date of graduation of such enterprise from its original category is
(dd/mm/yyyy) which is within the period of 3 years from the date of graduation of such
enterprise from its original category as notified vide S.D. No. 3322(E) dated 01.11.2013
published in the gazette notification dated 04.11.2013 by Ministry of MSME.

Date:

(Signature)

Name -

Membership number -

Seal of Chartered Accountant

ALL DIMENSIONS ARE IN MILLIMETRES

32P9	-0.026 -0.088	±0.035 +0.000
------	------------------	------------------

3.2/1.8/

DRAWING NO. 3-M-02A56-15314

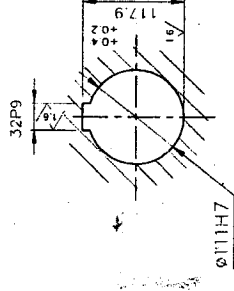
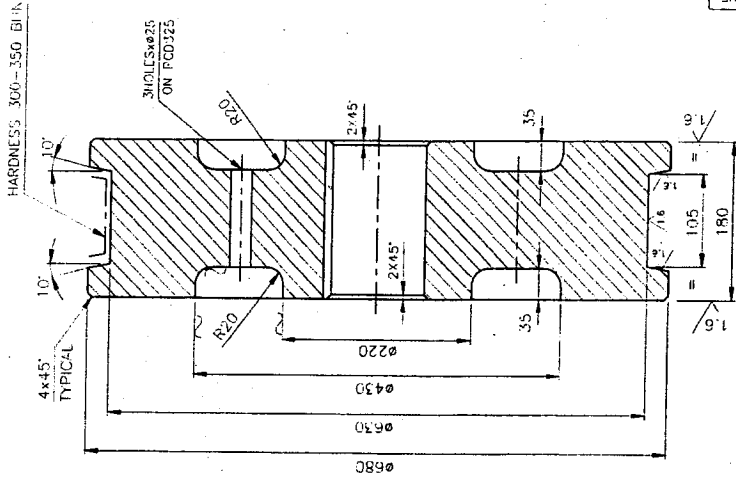

SUPERCEDED BY DRG. NO.: 4M02A5629292

ITEM NO	IS 1875	DESCRIPTION	BAR 0680 x 180	IS 5517	400.68
EQPT:	EOT CRANE / UNICON 20T/10T/28.65M		DRAWING NO	55 CB	UNIT WT
DEPT	MAS	GRADE OF UNCL D/M	SCALE	REF TO ASSY DWG NO	ITEM
DATE	2597	φ/M/F	1:5	400.68	REF TO OLD DWG NO
ALTERED	DESIGNED	APPROVED	TITLE		
REV	DATE	ZONE	LT WHEEL Ø680x111 x180		
CAUTION: THE INFORMATION ON THIS DOCUMENT IS THE PROPERTY OF BHARAT HEAVY ELECTRICALS LIMITED. IT MUST NOT BE USED DIRECTLY OR INDIRECTLY IN ANY WAY DETRIMENTAL TO THE INTEREST OF THE COMPANY.			DRAWING NO : 3-M-02A56-15314		
			REV 00		

NOTE:-

01. RAW MATERIAL OF SUITABLE SIZE SHALL BE SELECTED
02. TREAD DIAMETER AND FLANGE SURFACE TO BE HARDENED 300 TO 350 BHN TO A DEPTH OF 15-20MM

A3-SIZE

ALL DIMENSIONS ARE IN MILLIMETRES

25 P9	-0.022	-0.074	Ø91 H7	+0.035	+0.000
-------	--------	--------	--------	--------	--------

3.2/1.6

DRAWING NO. 3-M-02A40-15297

HARDNESS 300-350 BHN

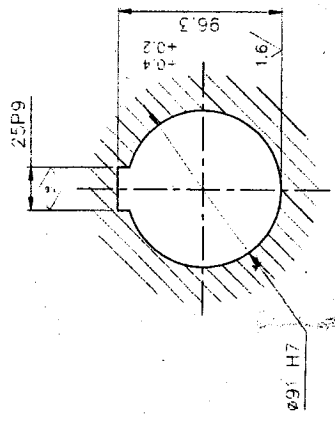
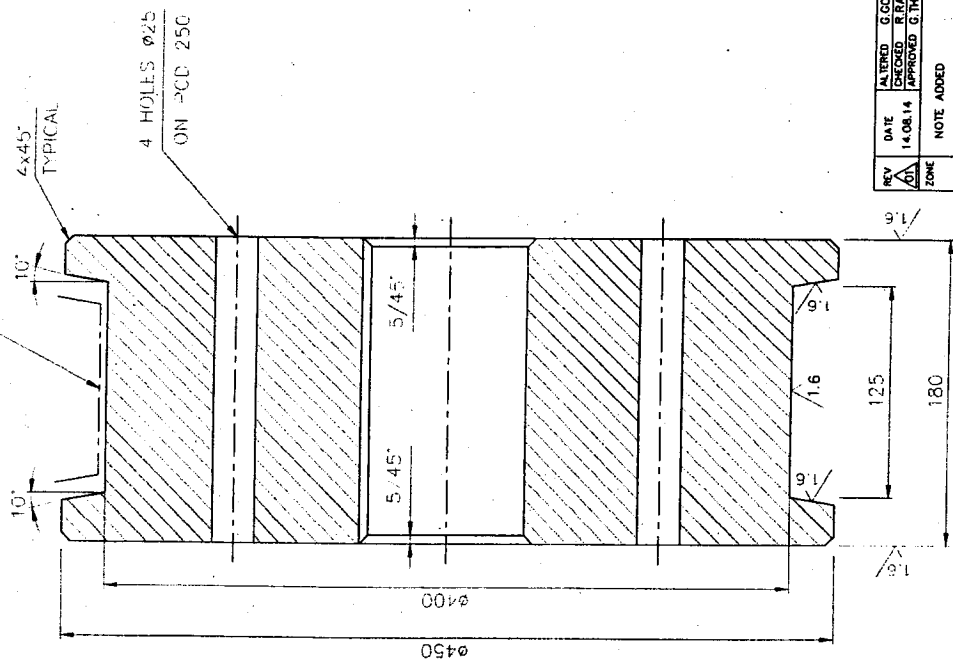

NOTE:

01. RAW MATERIAL OF SUITABLE SIZE SHALL BE SELECTED
02. TREAD DIAMETER AND FLANGE SURFACE TO BE HARDENED 300 TO 350 BHN TO A DEPTH OF 15-20MM

CAUTION: THE INFORMATION ON THIS DOCUMENT IS THE PROPERTY OF BHARAT HEAVY ELECTRICALS LIMITED. IT MUST NOT BE USED DIRECTLY OR INDIRECTLY IN ANY WAY DETRIMENTAL TO THE INTEREST OF THE COMPANY.

REV	DATE	ALTERED BY	APPROVED BY
01	14.08.14	G. RAMANURAJ	S. THAGARAJAN

NOTE ADDED
IS 5517 WAS IS 2004

ITEM NO	IS 1875	DESCRIPTION	DRAWING NO	UNIT WT	168.44
55 CB		BAR Ø450 x 180L		1	
EQPT.	EOT CRANE / 20T/16.75M / UNICON		LOC. NO. 7910 8133, 8134.		
DEPT	BHARAT HEAVY ELECTRICALS LTD				
MAS CODE	2587				
SCALE	1:2.5				
WEIGHT (kg)	168.44				
GRADE OF UNCL. DIM	Ø 1.6 / f 1.6				
REF TO ASSY Dwg NO					
REF TO OLD Dwg NO					
DATE	04.07.14				
SIGNATURE	S. Thagaran				
NAME	S. P. INKERSAL				
DRH	N. MADHURAM				
CHK	G. GOVINDARAJ				
APPD	S. P. INKERSAL				
DATE	04.07.14				
DRAWING NO	3-M-02A40-15297				
REV					

A3-SIZE

ALL DIMENSIONS ARE IN MILLIMETRES.

DRAWING NO. 3-M-02A40-15316

32P9	-0.026 -0.088	Ø111H7	+0.035 +0.000
------	------------------	--------	------------------

3.2/1.6/1.0

HARDNESS 300-350 EHN

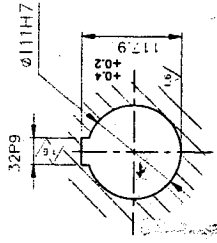
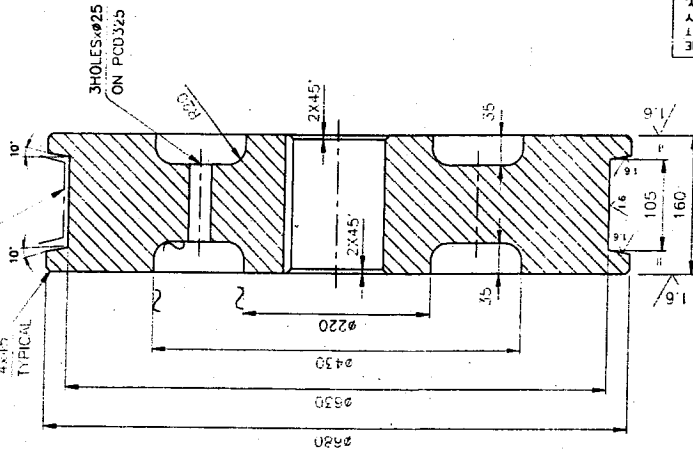

SUPERCEDED BY DRG. NO.: 4M02A4028540

NOTE:-

01. RAW MATERIAL OF SUITABLE SIZE SHALL BE SELECTED
02. TREAD DIAMETER AND FLANGE SURFACE TO BE HARDENED 300 TO 350 BHN TO A DEPTH OF 15-20MM

CAUTION: THE INFORMATION IN THIS DOCUMENT IS THE PROPERTY OF BHARAT HEAVY ELECTRICALS LIMITED. IT MUST NOT BE USED DIRECTLY OR INDIRECTLY IN ANY WAY DEPENDANT ON THE INTEREST OF THE COMPANY.

ITEM NO	IS 1875	DESCRIPTION	BAR Ø680 x 160	DRAWING NO	IS 5517	UNIT WT	339.00
EQPT.	CRANE	UNCON	207/28.85		55 C8	MAIL CODE	1
DEPT	MASS	GRADE OF UNITS DM	IS 2102		MAIL SPEC		
CODE	2397	SCALE	1:5				
REV	DATE	ALTERED					
		CHECKED					
		APPROVED					
ZONE							
TITLE		LT WHEEL Ø680xØ111 x160		DRAWING NO :		3-M-02A40-15316	
DEPT		BHARAT HEAVY ELECTRICALS LTD		REV		00	
MASS		HIGH PRESSURE BOILER PLANT		CODE		U 01	
GRADE OF UNITS DM		TRUCHIRAPALLI - 620014		U 01			
SCALE		1:5		DRAWING NO :		3-M-02A40-15316	
WEIGHT (Kg)		339.00		REV		00	
REF TO ASSY Dwg NO				DRAWING NO :		3-M-02A40-15316	
REF TO OLD Dwg NO				REV		00	
ITEM				DRAWING NO :		3-M-02A40-15316	
NAME		G.GOVINDARAJ		SIGNATURE			
DRN		G.GOVINDARAJ		DATE		05.08.14	
CHK		R.RAMAMURTHY		DATE		07.08.14	
APPD		G.THAGARAJAN		DATE		14.08.14	

A3-SIZE

ALL DIMENSIONS ARE IN MILLIMETRES

DRAWING NO: 3-M-02A45-15315

Ø140H7	+0.040 +0.000	36P9	-0.026 -0.088
--------	------------------	------	------------------

3.2 / 1.6

HARDNESS 300-350 BHN

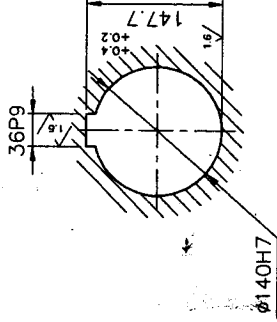
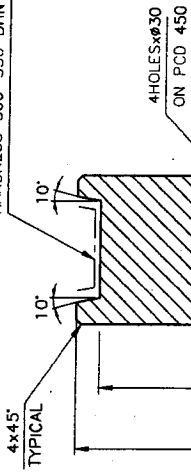

SUPERCEDED BY DRG. NO.: 4M02A4528383

- NOTE:-
01. RAW MATERIAL OF SUITABLE SIZE SHALL BE SELECTED
 02. TREAD DIAMETER AND FLANGE SURFACE TO BE HARDENED 300 TO 350 BHN TO A DEPTH OF 15-20MM

CAUTION: THE INFORMATION ON THIS DOCUMENT IS THE PROPERTY OF BHARAT HEAVY ELECTRICALS LIMITED. IT MUST NOT BE USED DIRECTLY OR INDIRECTLY IN ANY WAY DETRIMENTAL TO THE INTEREST OF THE COMPANY.

ITEM NO	IS 1875	DESCRIPTION	DRAWING NO	IS 5517	528.00
EQT:	EOT CRANE	UNIQUE	40/10T/28.5M	MATL. SPEC	QTY
DEPT	M&S	2587	SCALE	1:5	REF TO ASSY DWG NO
GRADE OF UNTOOL DM	Ø/M/F	15.2002	WEIGHT (Kg)	528.00	REF TO OLD DWG NO
Bharat Heavy Electricals Ltd HIGH PRESSURE BOILER PLANT TIRUCHIRAPALLI - 620014			SIGNATURE		
DRM			G. GOVINDARAJ		
CND			R. RAMAMURTHY		
APPD			G. THAGARAJAN		
DATE			05.08.14		
DATE			07.08.14		
DATE			14.08.14		
TITLE			DRAWING NO : 3-M-02A45-15315		
REV			U 01		
ZONE			00		

A3-SIZE

66ZS-04VZ0-W-3-M-02A40-15299

DRAWING NO.

ALL DIMENSIONS ARE IN MILLIMETRES

HARDNESS 300-350 BHN

3.2/1.6/√

18P9 -0.018 +0.030
-0.061 +0.000

4x45° TYPICAL

4 HOLES Ø25 ON PCD 200

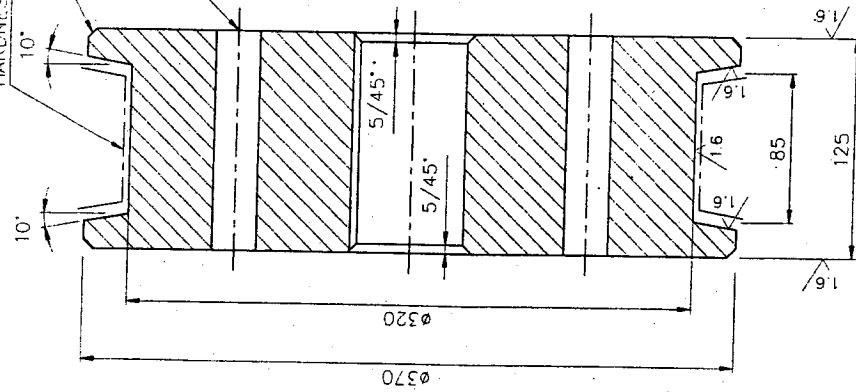

NOTE:-

- 01. RAW MATERIAL OF SUITABLE SIZE SHALL BE SELECTED
- 02. TREAD DIAMETER AND FLANGE SURFACE TO BE HARDENED 300 TO 350 BHN TO A DEPTH OF 15-20MM

REV	DATE	ALTERED	G. GOVINDARAJ
Δ	01.08.14	CHECKED	R. BALAJI
ZONE		APPROVED	G. THIRUGARAJAN

NOTE ADDED
IS 5517 WAS IS 2004

CAUTION: THE INFORMATION ON THIS DOCUMENT IS THE PROPERTY OF BHARAT HEAVY ELECTRICALS LIMITED. IT MUST NOT BE USED DIRECTLY OR INDIRECTLY IN ANY WAY DETRIMENTAL TO THE INTEREST OF THE COMPANY.

ITEM NO		DESCRIPTION		DRAWING NO		IS 5517		76.07	
1		BAR Ø370 x 125L IS 1875				55 C8		1	
EPT:		EOT CRANE / 201x22.7M / UNICON		LOC. NO. 7910 B133, B134		MATERIAL SPEC		QTY	
DEPT		MAS		GRADE OF UNCL DM		WEIGHT (Kg)		ITEM	
2397		15-2102		Ø7M/f		76.07		REF TO ASSY Dwg NO	
SCALE		1:2.5		SIGNATURE		DATE		REV	
15-2102				N. MADHURVEERAN		04.07.14		Δ	
TITLE		CT WHEEL Ø370xØ61x125L		DRN		04.07.14			
Bharat Heavy Electricals Ltd		HIGH PRESSURE BOILER PLANT		CHD		04.07.14			
TIRUCHIRAPALLI - 620014		S.P. INKERSAL		APPD		04.07.14			
DRAWING NO :		3-M-02A40-15299		REF TO OLD Dwg NO					
CDD CODE		U 01		REF TO OLD Dwg NO					

A3-SIZE