



BHARAT HEAVY ELECTRICALS LIMITED

(A Government of India Undertaking)
HIGH PRESSURE BOILER PLANT
PURCHASE DEPARTMENT - FOSSIL BOILERS
THIRUCHIRAPALLI - 620014
TAMILNADU (INDIA)

PHONE :2577331
GRAMS : BHARATELEC
FAX NO: 2520719
E-mail: srchandran@bheltry.co.in
Web:

429-002/A

	Enquiry No	Enquiry Date	Due Date for Quotation
	2661500429 - 55	16.10.2015	13.11.2015
<p>Please quote Enquiry No, Date and due date in all correspondences. This is only a request for quotation and not an order. Bid should be submitted in two parts. 1.Techno-commercial bid (Part-I) and 2.Price bid(Part-II) in a separate sealed cover and both covers must be placed in a third cover and sealed. Our Enquiry No., Enq. date & Enq. Due date must be written on all three covers.</p>			

Item	Description	Unit	Quantity	Delivery Quantity	Schedule Date
10	SCREW ROD AS PER DRAWING NO 3M01A0202214 VENDOR QUALIFYING CRITERIA Only those vendors who satisfy the following conditions will get qualified to participate in the tender: 1.Vendor should have minimum 3 year experience in this field. 2.Previous PO details for supplying similar kind of items should be submitted along with offer. Otherwise offer will be rejected. 3.Company profile details has to be provided along with offer. 4.BHEL reserves the right to visit the vendor's works for verifying the manufacturing facilities and any other credential furnished by the vendor in case the information furnished with the offers found to be false /incorrect, the offer shall be rejected. 5.Vendors who have not supplied the ordered items beyond the delivery schedule against our previous PO placed on them from 01.04.14 are liable for rejection / May not be considered for evaluation. Hence the vendors who are all regularly supplying to our POs shall quote for these items.	NO	2.000	2.00	13.02.16
20	WORM WHEEL NUT AS PER DRAWING NO 4M01A0201409 NOTE: SL.NO. 10 AND 20 ARE MATING COMPONENTS. HENCE THESE ITEMS SHOULD BE PROCURED FROM SINGLE SOURCE ONLY.	NO	4.000	4.00	13.02.16
30	CYLINDER BLOCK AS PER DRAWING NO 2M04D0705292	NO	2.000	2.00	13.02.16
40	CYLINDER BLOCK AS PER DRAWING NO 2M04D0705293	NO	2.000	2.00	13.02.16
50	CLAMPING PAD AS PER DRAWING NO 2M04D0703790	NO	2.000	2.00	13.02.16

The offers should reach us 30 minutes before the time of opening of tenders. The offers will be opened at 14.30 hrs on the due date of tender in the presence of tenderers who have submitted their offer and who may like to be present for the tender opening.Late and delayed offers are liable to be rejected.

Yours faithfully,
For BHARAT HEAVY ELECTRICALS LIMITED

 S. MANOJ KUMAR
 MANAGER / PURCHASE
 (FOSSIL BOILERS)
 THIRUCHIRAPALLI
 Yours faithfully,
 BHARAT HEAVY ELECTRICALS LIMITED



BHARAT HEAVY ELECTRICALS LIMITED

(A Government of India Undertaking)
HIGH PRESSURE BOILER PLANT
PURCHASE DEPARTMENT - FOSSIL BOILERS
THIRUCHIRAPALLI - 620014
TAMILNADU (INDIA)

Page
2/3
PHONE :2577331
GRAMS : BHARATELEC
FAX NO: 2520719
E-mail: srchandran@bheltry.co.in
Web:

2661500429 / 16.10.2015

23505

Sl. No.	Description	Unit	Quantity	Rate	Amount	Date
60	CYLINDER BLOCK AS PER DRAWING NO 2M04D0703796	NO	2.000	2.00	13.02.16	
70	CYLINDER BLOCK AS PER DRAWING NO 2M04D0703799	NO	2.000	2.00	13.02.16	
80	WORM WHEEL AS PER DRAWING NO 2M08F1805289	NO	2.000	2.00	13.02.16	
90	WORM SHAFT AS PER DRAWING NO 3M08F1815450 NOTE: SL.NO. 80 AND 90 ARE MATING COMPONENTS. HENCE THESE ITEMS SHOULD BE PROCURED FROM SINGLE SOURCE ONLY.	NO	2.000	2.00	13.02.16	
100	HOLLOW SHAFT AS PER DRAWING NO 3M04B2515461	NO	10.000	10.00	13.02.16	
110	SHAFT AS PER DRAWING NO 3M04B2515462	NO	10.000	10.00	13.02.16	

General Note:

GENERAL NOTE:PLEASE SUBMIT YOUR OFFER IN "TWO PART BID SYSTEM" AS PER THE ANNEXURES ENCLOSED.

ENCLOSURES:ANNEXURE II,III,IV,V,VI,VII

All the tenders may be addressed to the following address:

**The Tender Opening Cell / MM
Room No: 26, Building 24, Ground Floor
Bharat Heavy Electricals Limited
TIRUCHIRAPALLI 620014**

In case personal delivery of the offer, it shall be dropped into the respective box kept in Room No: 26, after duly entering the data in the system.

Offers will be accepted only up to 14.00 Hrs on the due date. Therefore, vendors shall ensure to submit the offers well before this time. All due date extension requirements should be addressed to the respective Purchase mail IDs. All the due date extension requests from vendors will be considered only up to 48 hours before the due date and time.

Vendors are requested to avoid submission of offers through e mail / fax. In case of any unavoidable situation, offers shall be sent through e mail to the following mail ID only tender_cell@bheltry.co.in.

As tenders are being opened by Common Tender Opening Cell, offer covers should be sealed with tenderer's distinctive seal and super scribed with correct Tender No. item of supply and due date of opening.

The offers will be opened at 14.30 hrs on the due date of the tender in the presence of tenderers who have submitted their offer and who may like to be present for the tender opening. Late and delayed offers

The offers should reach us 30 minutes before the time of opening of tenders.
The offers will be opened at 14.30 hrs on the due date of tender in the presence of tenderers who have submitted their offer and who may like to be present for the tender opening.Late and delayed offers are liable to be rejected.

Yours faithfully,
For BHARAT HEAVY ELECTRICALS LIMITED

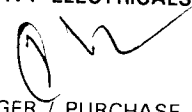
MANAGER / PURCHASE
(FOSSIL BOILERS)
Yours faithfully,



BHARAT HEAVY ELECTRICALS LIMITED

(A Government of India Undertaking)
HIGH PRESSURE BOILER PLANT
PURCHASE DEPARTMENT - FOSSIL BOILERS
THIRUCHIRAPALLI - 620014
TAMILNADU (INDIA)

Page
3/3
PHONE :2577331
GRAMS : BHARATELEC
FAX NO: 2520719
E-mail: srchandran@bheltry.co.in
Web:

2661500429 / 16.10.2015

23505

are liable to be rejected.

The bidder along with its associate/ collaborators/ sub-contractors/ sub-vendors/ consultants/ service providers shall strictly adhere to BHEL fraud prevention policy displayed on BHEL website <http://www.bhel.com> and shall immediately bring to the notice of BHEL management about any fraud or suspected fraud as soon as it comes to their notice.

Enclosures:

"LD clause has to be confirmed without fail."

The offers should reach us 30 minutes before the time of opening of tenders.
The offers will be opened at 14.30 hrs on the due date of tender in the presence of tenderers who have submitted their offer and who may like to be present for the tender opening. Late and delayed offers are liable to be rejected.

Yours faithfully,
For BHARAT HEAVY ELECTRICALS LIMITED

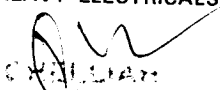
V. CHANDRAN
MANAGER / PURCHASE
FOSSIL BOILERS
THIRUCHIRAPALLI
16.10.2015

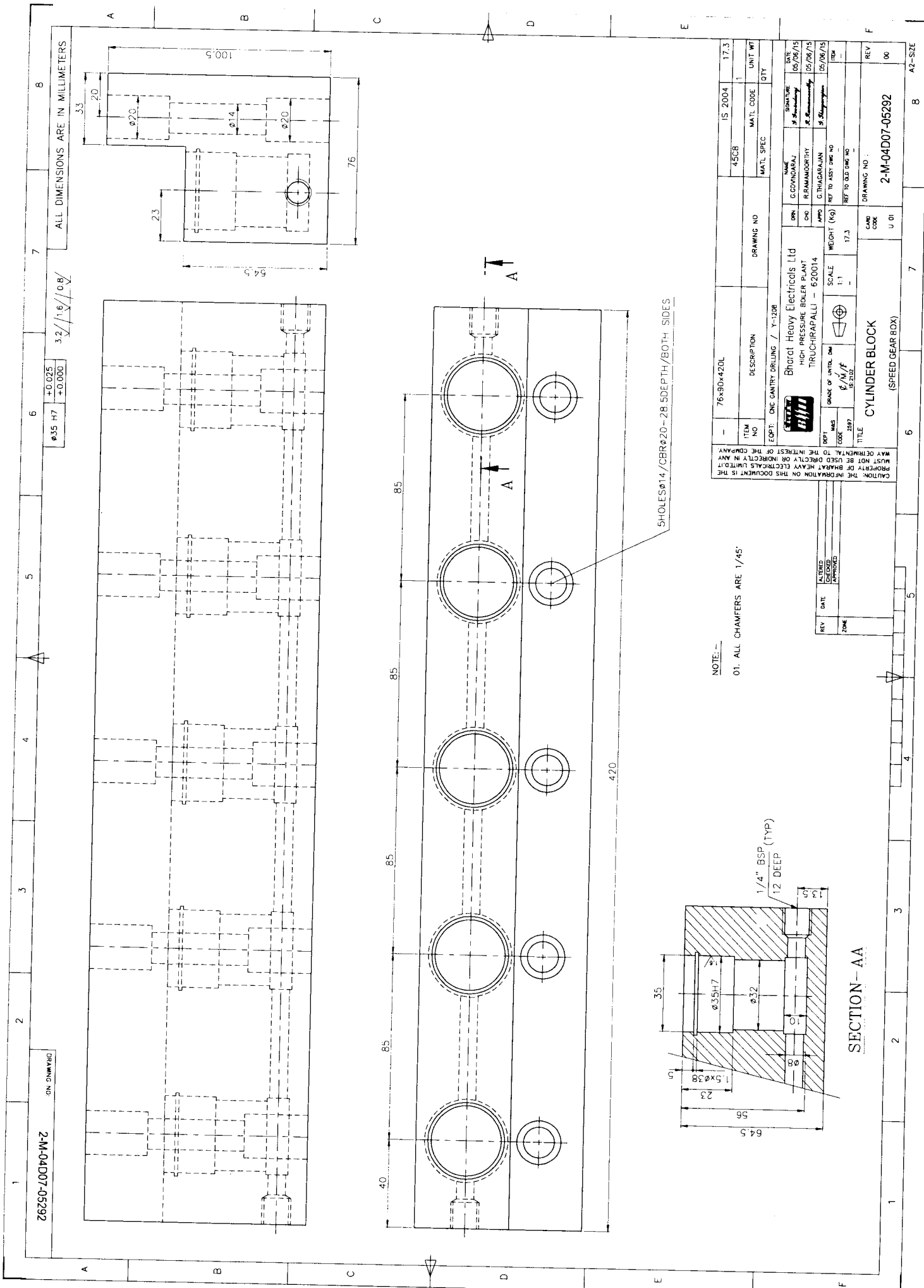

ALL DIMENSIONS ARE IN MILLIMETERS

Ø35 H7
+0.025
-0.000

3.2 / 1.6 / 0.8

2-M-04D07-05292

NOTE: -
01. ALL CHAMFERS ARE 1/45°

5 HOLES Ø14 / CBRØ20 - 28.5 DEPTH / BOTH SIDES

ITEM NO	76x90x420L	DESCRIPTION	DRAWING NO	IS 2004	17.3
UNIT WT	45CB	MATL CODE	1		
QTY		MATL SPEC			
DATE	05/08/15	SIGNATURE			
CHK	G. GOVINDARAJU				
CHK	R. RAMAMOORTHY				
APPD	G. THAGARAJAN				
REF TO ASSY DWG NO					
REF TO OLD DWG NO					
SCALE	1:1	WEIGHT (KG)	17.3		
SCALE	1:1				
CODE	2587				
ZONE					
REV		DATE			
ALTERED		APPROVED			
CAUTION: THE INFORMATION ON THIS DOCUMENT IS THE PROPERTY OF BHARAT HEAVY ELECTRICALS LIMITED. IT MUST NOT BE USED DIRECTLY OR INDIRECTLY IN ANY WAY DETRIMENTAL TO THE INTEREST OF THE COMPANY.					
Bhart Heavy Electricals Ltd HIGH PRESSURE BOILER PLANT TIRUCHIRAPPALLI - 620014			DRAWING NO : 2-M-04D07-05292		
TITLE CYLINDER BLOCK (SPEED GEAR BOX)			REV 00		

SECTION-AA

1 2 3 4 5 6 7 8 A2-SIZE

THIS DRAWING IS OUR SOLE PROPERTY AND NOT TO BE REPRODUCED OR COPIED IN ANY FORM OR BY ANY MEANS WITHOUT THE WRITTEN PERMISSION OF BENTLEY SYSTEMS, INC. OR ITS AFFILIATES.

39-608 A

+0.025
0.000

38/109

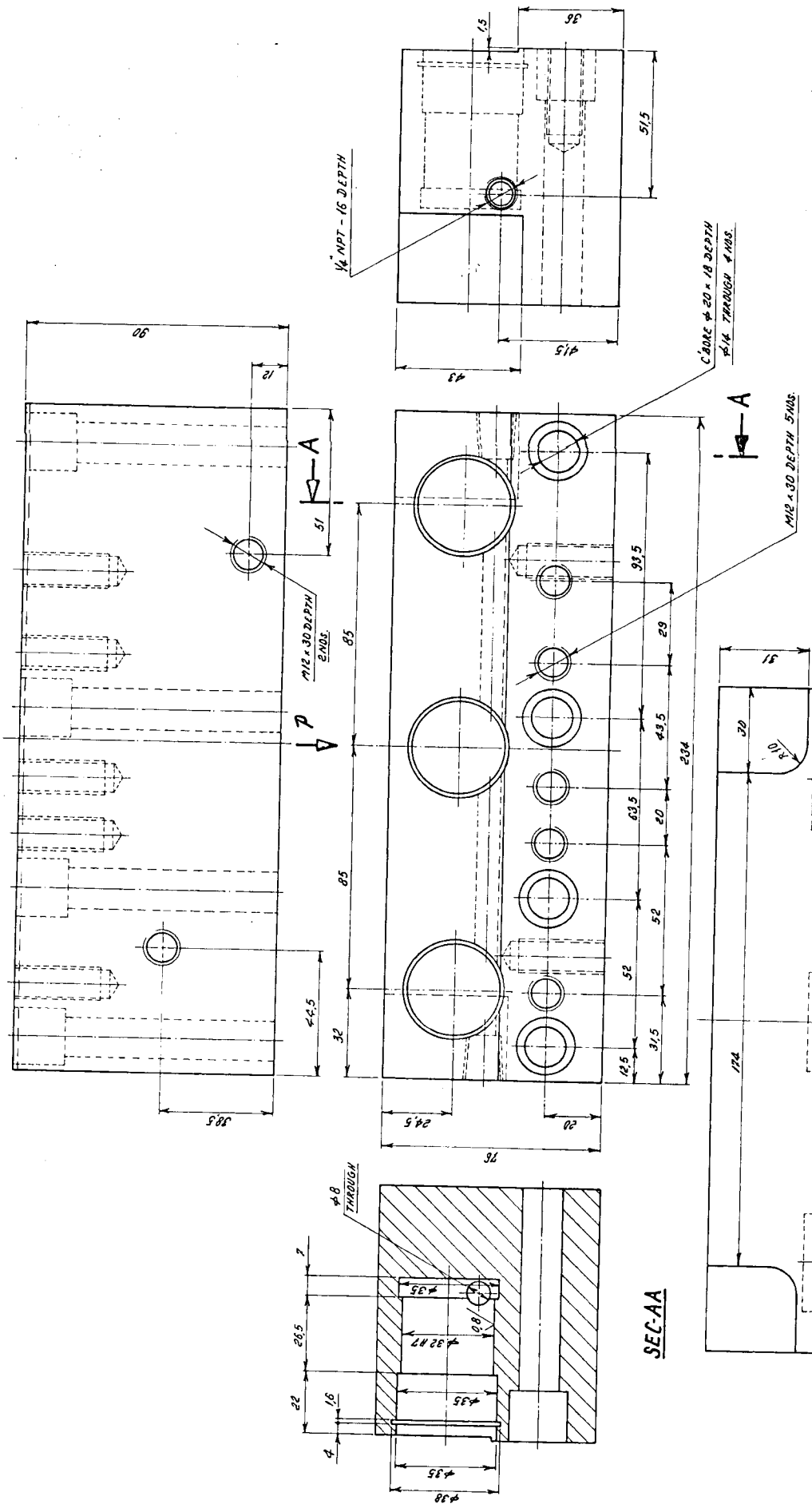

SEC-AA

REFERENCE: 101 FOR MANUFACTURE.

1	PL. 001-85 x 240	APME	DATE	07
	DESCRIPTION	MATERIAL	STD./SIS	93
	ALTERATIONS	22-07	22-00	
SCALE	DRAWN	CHECKED	APPROVED	DATE
1:1				
MACHINE: N.C. GAMMAT MARILLON		TYPE: V. 208		
TITLE		DRAWING No. 07		
CYLINDER BLOCK		Total wt. (kg.) 9.83		
		REV.		

VIEW-P

Sheet No. 07

2-M-04d-3796

No. of Sheets

ALL DIMENSIONS ARE IN MILLIMETRES

DRAWING NO: 3-M-04B25-15461

±0.000	±0.012	±0.012	5P8
-0.013	+0.001	+0.012	
-0.013	+0.001	-0.042	

3.2/1.6/0.8

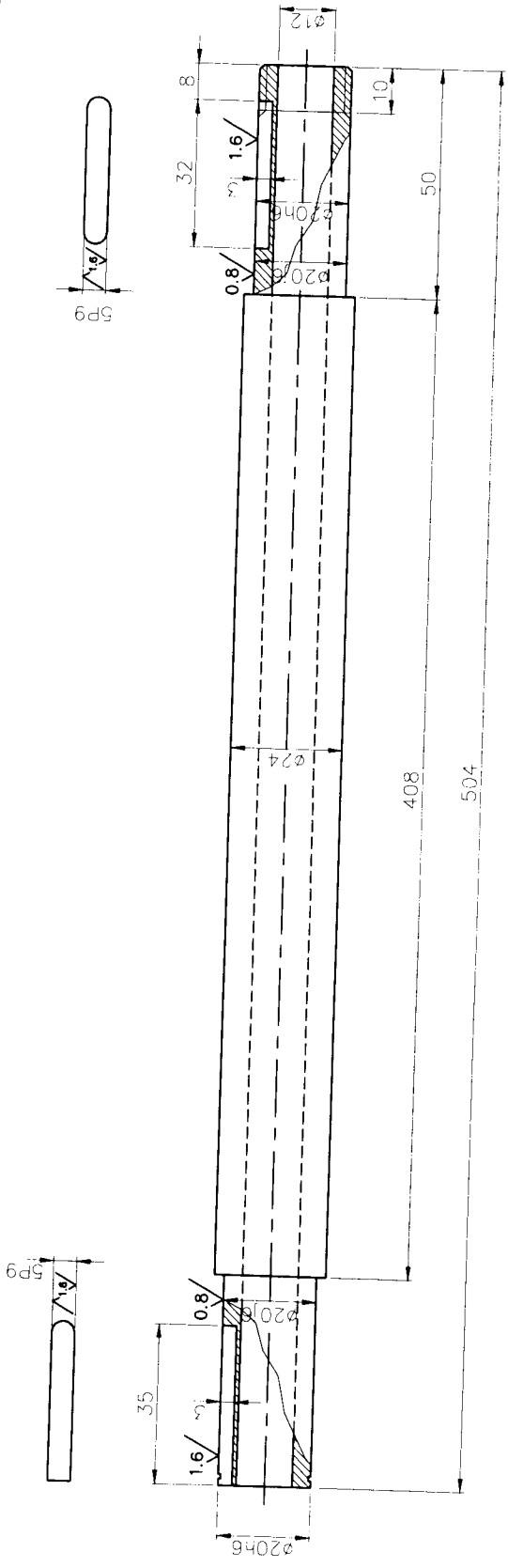

CORNERS TO BE CHAMFER TO 1/45°

CAUTION: THE INFORMATION ON THIS DOCUMENT IS THE PROPERTY OF BHARAT HEAVY ELECTRICALS LIMITED. IT MUST NOT BE USED DIRECTLY OR INDIRECTLY IN ANY WAY DETRIMENTAL TO THE INTEREST OF THE COMPANY.

01	ROD $\phi 24 \times 504L$	IS 1762	DESCRIPTION	DRAWING NO	IS 2004	UNIT WT	1.24	
ITEM NO	RADIAL DRILLING / VOP 100			MATL CODE	45 C8	MATL SPEC		
Bharat Heavy Electricals Ltd HIGH PRESSURE BOILER PLANT TIRUCHIRAPALLI - 620014				DRN	G. GOVINDARAJ	DATE	05.06.15	
DEPT	GRADE OF UNTOL D/M	SCALE	WEIGHT (kg)	CHKD	R. RAMAMOORTHY	DATE	05.06.15	
CODE	$\phi/M/F$ IS.2102	1:1	1.24	APPD	G. THIAGARAJAN	DATE	05.06.15	
2597				REF TO ASSY DWG NO		REF TO OLD DWG NO		
TITLE HOLLOW SHAFT OD24xID12x504L (HEAD STOCK MOVEMENT)				CARD CODE	U 01	DRAWING NO :	3-M-04B25-15461	
REV	DATE	ALTERED	CHECKED	APPROVED	REV			00
ZONE					REV			00

A3-SIZE

ALL DIMENSIONS ARE IN MILLIMETRES

DRAWING NO: 3-M-08F18-15450

φ45 H7	+0.025	14 P9	-0.018
	0.000		-0.061

3.2//1.6/

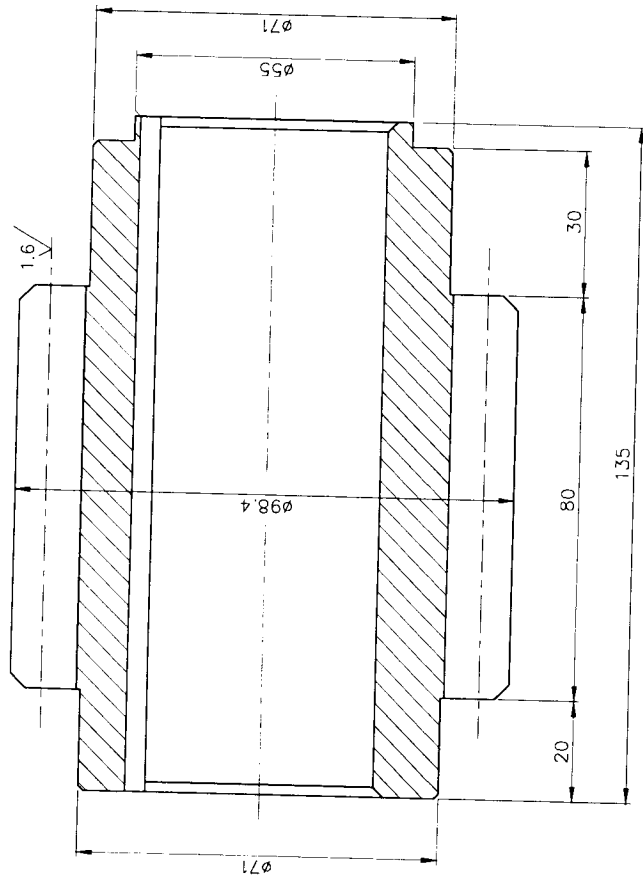
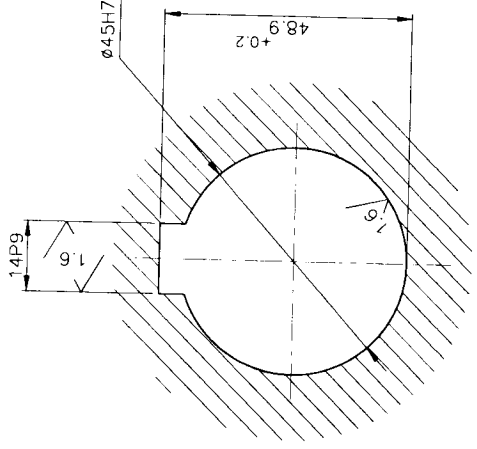
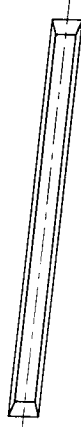

NOTE: -

1. SHARP CORNERS TO BE REMOVED
2. HARDENED TO HRC.35 ±2

CAUTION: THE INFORMATION ON THIS DOCUMENT IS THE PROPERTY OF BHARAT HEAVY ELECTRICALS LIMITED IT MUST NOT BE USED DIRECTLY OR INDIRECTLY IN ANY MANNER DETRIMENTAL TO THE INTEREST OF THE COMPANY.

ITEM NO	DESCRIPTION	DRAWING NO	MATL CODE	MATL SPEC	QTY
0100x135 IS:1762			55C8		1
EOPT: LARGE CNC LATHE /LC140N					
Bharat Heavy Electricals Ltd HIGH PRESSURE BOILER PLANT TIRUCHIRAPALLI - 620014					
DEPT	M&S	CODE	2597		
GRADE OF UNTOL DIM	φ/M/F	IS:2102			
SCALE	1:1	WEIGHT (Kg)	4.67		
REF TO ASSY DWG NO					
REF TO O.D DWG NO					
DRN	S.SELVAMANICKAM	SIGNATURE			
CHD	G.GOVINDARAJ	S. Govindaraj			
APPD	G.THAGARAJAN	S. Thagaranjan			
DATE	18.05.15	DATE			
18.05.15		DATE			
19.05.15		DATE			
20.05.15		DATE			
IS:5517	4.67	IS:5517			
55C8	1	55C8			
TITLE: WORM SHAFT Ø98.4x135L (RH) (TAIL STOCK RAPID MOMENT ASSY.)					
DRAWING NO: 3-M-08F18-15450					
REV: 00					

NO.OF STARTS	SINGLE
MODULE	6
PRESSURE ANGLE	20°
LEAD ANGLE	3° 58' 20"
HAND OF HELIX	RH
AXIAL PITCH	18.84
MATING WORM WHEEL DRAWING NO:	2-M-08F18-05289
CENTRE DISTANCE	145.2

REV	DATE	ALTERED
		CHECKED
		APPROVED
ZONE		

A3-SIZE

R35,7 R28 R32

3.2/1.6/1.6

φ90f8	-0.036
	-0.090
φ65k6	+0.021
	+0.002

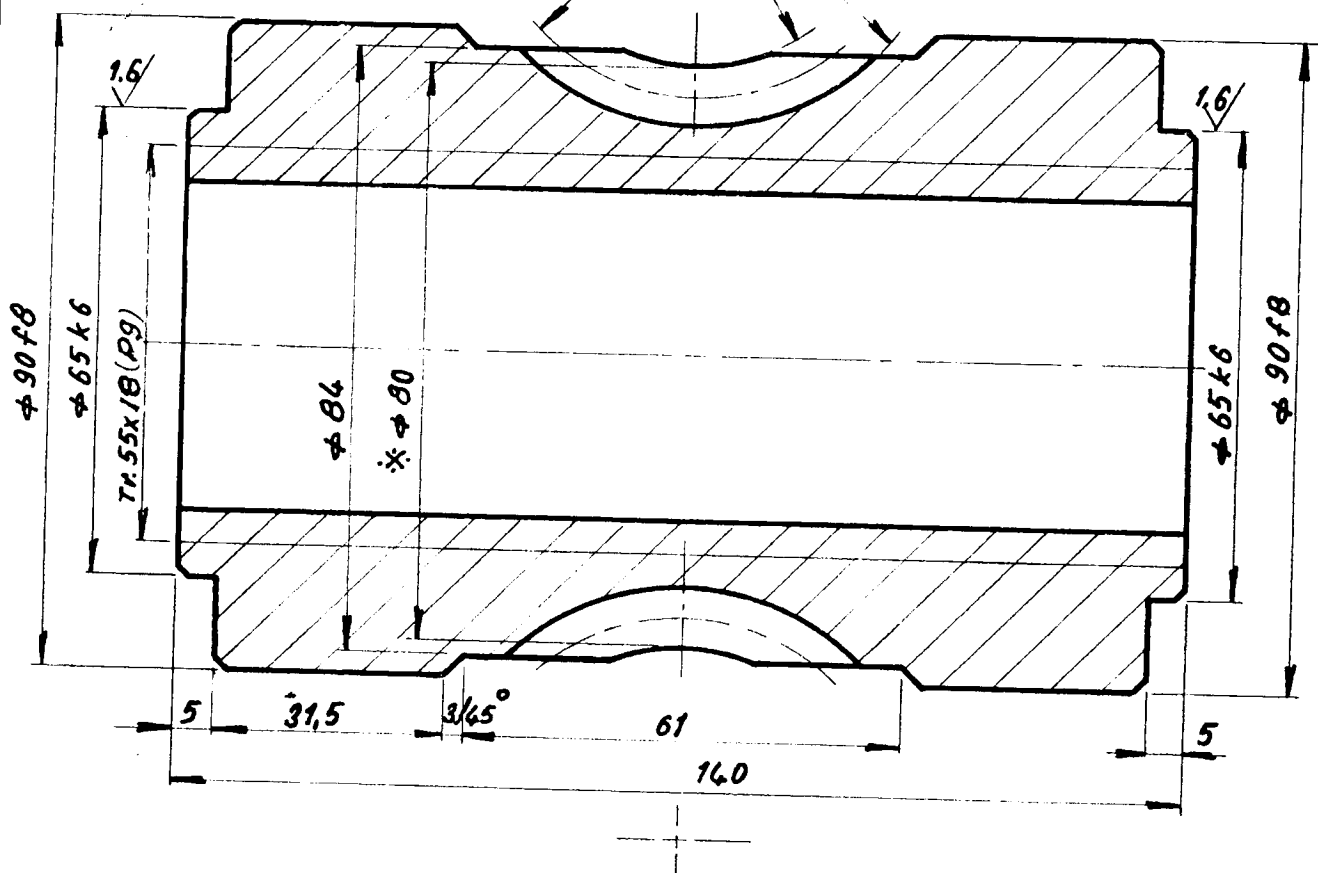

NOTE: - *

- BOTH WORM AND WORM WHEEL SHOULD BE REPLACED AS A PAIR
- ORIGINAL DIA WAS 82
- FOR REPAIR METHOD REF. DRG. NO. 4-M-01a-6485
- FOR SCREW ROD REF. DRG. NO. 3-M-01a-2214

NO. OF TEETH	18
MODULE	4
P.C.D.	72
PRESSURE ANGLE	20°
NO. OF START ON WORM	SINGLE
HAND OF HELIX	R.H.
HELIX ANGLE	3°24'
PITCH	12.87
* CENTRE DISTANCE	68
MATING WORM	4-M-01a-1410

Cu Sn 8 Zn
19:306

NO. OF PIECES	DESCRIPTION	SEMI PRODUCT	FINAL MATERIAL	INITIAL MATERIAL	SCRAP SORT	NET WT	GROSS WT	DRAWING NO.	ITEM NO.
REMARKS		TOTAL NET wt (kg)							
SCALE	DRAWN	REFERENCE	ALTERATIONS	DATE	SIGNATURE	ALTERATION INDEX			
1:1	CHECKED								
	APPROVED								
	STDS. OFFICER								
	DATE	4-7-1967							



MACHINE: VERTICAL BORING & TURNING MILL TYPE: SK 25 A INV. NO. 200.310
TITLE: WORM WHEEL NUT (CROSS FEED) DRAWING NO: 4-M-01a-1409

02
4-M-01a-1409

CAPITAL PURCHASE
COMMERCIAL TERMS AND CONDITIONS

1.0 QUOTATIONS

The Bidders shall submit the offer in **TWO INNER ENVELOPES** as indicated below which shall be sealed in one outer envelope.

Envelope I This sealed envelope should contain all the copies of technical bid together with un-priced commercial bid & annexure III. This envelope should be clearly marked **'Part I - Technical and commercial bid'**,

Indicating Enquiry No., Due Date and Address & Reference of the Bidder.

Envelope II This sealed envelope should contain **price as per Annexure-IV format**. This envelope should be clearly marked **"Part II - Price bid"**, indicating **Enquiry No., Due Date and Address & Reference of the Bidder**.

Both the envelopes (Part I & II) shall be put in one cover (**Envelope III**), duly sealed, superscribing as Part I and Part II of Enquiry No., due date of opening and the address and reference of the Bidder

The above offer should reach this office on or before the due date by 14.00 hours (IST). Late offers will not be considered.

Tender should not be addressed to any individual's name

The Tender Opening Cell/MM
Room No-26 , Building – 24 , Ground Floor
Bharat Heavy Electrical Limited
Tiruchirapalli- 620014 .

Tenders should be free from **CORRECTION AND ERASURES**, Corrections if any, must be attested. All Amounts shall be indicated both in words as well as in figures. Where there is difference between amount quoted in words and figures, amount quoted in words shall prevail. Offers should be in **ENGLISH** and accompanied by detailed technical literature, catalogue and detailed dimensional drawings in **ENGLISH** or otherwise, the offers will not be considered.

2.0 OPENING OF TENDERS

The Part I - Technical & commercial bid alone would be opened on the Tender opening date.

The Part II - Price bid of technically suitable Bidders alone would be opened. The Technically Suitable Bidders would be informed about the tender opening date through e-mail.

Clarifications if any required by BHEL for Technical evaluation **would be** sought from Bidders before opening of Part II - price bid

For any queries clarifications the bidders may contact us through our FAX NO. +91 431 2520719 or through e-mail <arunachal@bheltry.co.in >&< chells@bheltry.co.in>

Annexure For Techno Commercial Bid

Check List - to be filled and submitted along with Technical Bid

BHEL Commercial Terms and Conditions for Indigenous Supplies	Vendor's Confirmation / Comments
Technical confirmation to BHEL's Specification as called for in BHEL Format shall be furnished. If needed additional sheets shall be used.	
Prices shall be quoted item wise only as per the model format enclosed	
Prices shall be quoted on " FIRM PRICE " basis only The prices should be only on F.O.R / Despatching station basis with Packing & Forwarding charges if any. Applicable % of ED & Sales Tax, Freight & Insurance, Installation & Commissioning Charges should be clearly Indicated	
Validity of offer shall be for a minimum period of 120 days from the date of Tender opening	
Delivery period from the date of Letter of Intent / Purchase order shall be clearly mentioned in the offer	
Liquidated damages @ '0.5% per week subject to a maximum of 10% of the order value shall be applicable for delay in deliveries For Details Refer Annexure- v	
Following Risk Purchase clause shall be applicable The purchaser at his option will be entitled to terminate the contract and to purchase elsewhere at the risk and cost of the seller either the whole of the goods or any part which the supplier has failed to deliver or dispatch within the time stipulated or if the same were not available, the best and the nearest available substitute therefore The supplier shall be liable for any loss which the Purchaser may sustain by reason of such risk purchases	
Payment term for supply portion: Payment term is 100% direct payment after 45 days from the date of receipt and acceptance of materials For details Refer Annexure- v	
Erection / commissioning: (if applicable only) Erection / commissioning charges if any has been mentioned in the offer or else confirmation that Erection /commissioning shall be done at free of cost is available in the offer,	
The equipment shall be guaranteed for a period of 12 months from the date of commissioning	
Final inspection and acceptance of equipment will be after installation at BHEL, Trichy	
The vendor shall provide necessary drawings, Test Certificates and Operating Maintenance Manuals etc., as called for in the Technical Specification, in the required number of copies at no extra cost	
Any warranty replacement during warranty period shall be supplied free of charge on FOR BHEL, Trichy basis.	
Offers should be submitted only in sealed cover super-scribing clearly the Enquiry reference and due date.	
% of Excise Duty with cess	
% of TAX (CST/VAT) (INGST with FORM-17 or CST with C-FORM)	
Packing & Forwarding Charges (if any in % only)	
Percentage of Freight& transit insurance charges, if any Freight charges from Dispatching station to BHEL, Tiruchirappalli • Supplier should quote for F.O.R-BHEL Trichy Stores.	
As per Commercial terms and conditions, acceptance for participation in Reverse auction (RA). Yes/No to be indicated	
Name of the person for participating reverse auction	
Land Line Number	
Fax Number	
Mobile Number	
E-mail ID	

NOTE:-

- It is confirmed that all the terms and conditions stipulated in the Enquiry have been fully understood by us and all clarifications & details have been obtained.
- Your offer should be indicating applicable if any P&F Charges, % of ED, Sales Tax -CST or VAT, Service Tax), Freight, Insurance and Installation and Commissioning Charges etc., as per our Price Format
- Your specific acceptance to our Payment terms, LD & Risk Purchase Clause are essential for consideration of your offer. Other wise your offer is liable for rejection.
- No row shall be left blank. Please indicate NA, in case the item is "not applicable"

Annexure For Price Bid

**Bharat Heavy Electricals Limited TIRUCHIRAPPALLI CAPITAL PURCHASE
MODEL PRICE BID FORMAT FOR INDIAN BIDDERS**

Annexure-IV

Enquiry No. & Date:
Bidder's Offer No. & Date:

Sl No	Description of item	Unit	Quantity	Rate in Rs.	Value in Rs.
	TOTAL VALUE IN RS.				
	Packing & Forwarding charges in % if any				
	Freight & Insurance Charges in % if freight charges are not mentioned it will be considered as FOR-BHEL TRICHY.				
	Excise Duty (indicate in %)				
	A) TNGST — VAT (%)				
	B) CST with C-FORM — (%)				
	C) CST without C-Form — (%)				
	Approximate Net weight of the total consignment				
	Approximate Gross weight of the total consignment				
	Approximate Dimensions of the Consignment				
	The price indicated shall be inclusive of all accessories, spares etc. as given in the scope of supply. Individual item-wise break-up price shall be attached as an annexure to this price bid format.				

Signature & Seal of Vendor

NOTE:

1. The price bid should be submitted only as per the above format. No row shall be left blank. Please indicate NA, in case the item is "not applicable".
2. Prices shall be quoted item-wise only as per the above format.
3. If Price quoted is Inclusive of ED, the included ED Value and Base Value shall be indicated item-wise.

Payment Term (Indigenous)	
If materials are receivable at Stores/Trichy <u>without</u> PBG	Payment term is 100% direct payment after 45 days from the date of receipt and acceptance of materials.
If materials are receivable at Stores/Trichy <u>with</u> PBG	Payment term is 100% direct payment after 45 days from the date of receipt and acceptance of materials and against 10% PBG valid for the warranty period.
Any deviation in the above payment term will attract loading as mentioned below. "Base rate of SBI (as applicable on the date of bid opening. Techno-commercial bid opening in case of two part bids) + 6% shall be considered for loading for the period of relaxation sought by bidders.	

Offers of indigenous Suppliers with any other Payment terms will be rejected.

Liquidated Damages / Penalty -

The delivery of the goods specified in the purchase order should be made within the time prescribed. LD for delay in 'Supply' and/or 'E&C' will be applicable to the delays attributed to vendor. LD will be considered separately for 'Delivery' and 'E&C'. Where the seller supplies or dispatches the goods, beyond the delivery period Liquidated damages shall be applicable 0.5% of the total order value per week or part thereof subject to a maximum of 10% of the total order value.

Material Despatched after Due date: Once the delivery due date is crossed, bills have to be clubbed till final despatch and forwarded for processing of payment as a single bunch. LD percentage will be calculated from Delivery due date to final despatch date.

The rate of LD for delayed E&C shall be @ 0.5% per week of delay of total PO value (Supply + E&C) in E&C subject to a maximum of 10% of total PO value (Supply + E&C).

For staggered delivery schedule, LD shall be 0.5% of the undelivered portion per week of the delay or part thereof subject to a maximum of 10% of the total order value.

Any deviation from the above LD clause, loading will be applied to the extent to which it is not agreed by the bidder (at offered value).

For the purpose of Imposing LD, the FOB delivery (B/L date) shall be considered.

Guarantee / Warranty Period – (if applicable)

Normally No deviation permitted and the deviated offers are liable for rejection.

Ranking-

BHEL will consider the ranking after the loading is applied as referred above wherever deviations are observed.

Performance Bank Guarantee – (if applicable)

Normally No deviation permitted and the deviated offers are liable for rejection.

Fraud prevention clause: The bidder along with its associate/collaborator/sub-contractor/sub-vendor/consultants/service providers shall strictly adhere to BHEL fraud prevention policy displayed on BHEL website <http://www.bhel.com> and shall immediately bring to the notice of BHEL management about any fraud or suspected fraud as soon as it comes to their notice.

NOTE:-

1. If the due date of tender opening happens to be a holiday, the tenders will be opened on the next working day.
2. BHEL reserves the right to go for a reverse auction (RA) instead of opening the submitted sealed bid which will be decided after technical evaluation. Information and general terms and conditions covering RA are given in commercial terms and conditions.
3. Corrigendum if any, with respect to this tender will be hosted only in the website <http://www.bhel.com> or <http://tenders.gov.in>. You are requested to visit the website regularly for updates.

Special Provisions for Micro and Small Enterprises (MSE)

1. 20% of the tendered quantity is earmarked for MSE suppliers in this tender.
2. Out of the 20% tendered quantity reserved for MSE suppliers, 4% shall be earmarked for procurement from MSE owned by SC/ST entrepreneurs.
3. In case MSE vendor participating in the tender quotes within the price band of L1+15%, they will be allowed to supply the portion of the requirement subject to acceptance of L1 price by MSE vendor. In case of more than one such MSE, the supply shall be shared proportionately.
4. "MSE suppliers can avail the intended benefits only if they submit along with the offer, attested copies of either EM II certificate having deemed validity (five years from the date of issue of acknowledgement in EM-II) or valid NSIC certificate or EM II certificate along with attested copy of a CA certificate (Format enclosed at Annexure -VII where deemed validity of EM II certificate of five Years has expired) applicable for the relevant financial year (latest audited). Date to be reckoned for determining the deemed validity will be the date of bid opening (Part 1 in case of two part bid). Non submission of such documents will lead to consideration of their bid at par with other bidders. No benefit shall be applicable for this enquiry if any deficiency in the above required documents are not submitted before price bid opening. If the tender is to be submitted through e-procurement portal, then the above required documents are to be uploaded on the portal. Documents should be notarized or attested by a Gazetted officer."

Certificate by Chartered Accountant on letter head

This is to Certify that M/S
(hereinafter referred to as 'company') having its registered office at
..... is registered under MSMED Act 2006, (Entrepreneur
Memorandum No (Part-II) dtd:.....,
Category: (Micro/Small)). (Copy enclosed).

Further verified from the Books of Accounts that the investment of the company as on
date..... as per MSMED Act 2006 is as follows:

1. **For Manufacturing Enterprises:** Investment in plant and machinery (i.e. original cost excluding land and building and the items specified by the Ministry of Small Scale Industries vide its notification No.S.O.1722(E) dated October 5, 2006 :
Rs.....Lacs
2. **For Service Enterprises:** Investment in equipment (original cost excluding land and building and furniture, fittings and other items not directly related to the service rendered or as may be notified under the MSMED Act, 2006:
Rs.....Lacs

The above investment of Rs.....Lacs is within permissible limit of
Rs.....Lacs forMicro / Small (Strike off which is not applicable)
Category under MSMED Act 2006.

Date:

(Signature)

Name -

Membership number -

Seal of Chartered Accountant