



# BHARAT HEAVY ELECTRICALS LIMITED

( A Government of India Undertaking )  
HIGH PRESSURE BOILER PLANT  
PURCHASE DEPARTMENT - FOSSIL BOILERS  
THIRUCHIRAPALLI - 620014  
TAMILNADU (INDIA)

Page 1/3  
PHONE :2577938  
GRAMS : BHARATELEC  
FAX NO: 2520719  
E-mail: tvenkat@bheltry.co.in  
Web:

	<b>Enquiry No</b> 2661600085 - 46	<b>Enquiry Date</b> 29.02.2016	<b>Due Date for Quotation</b> 24.03.2016
<p>Please quote Enquiry No, Date and due date in all correspondences. This is only a request for quotation and not an order. <b>Bid should be submitted in two parts. 1.Techno-commercial bid (Part-I) and 2.Price bid(Part-II) in a separate sealed cover and both covers must be placed in a third cover and sealed. Our Enquiry No., Enq. date &amp; Enq. Due date must be written on all three covers.</b></p>			

Item	Description	Unit	Quantity	Delivery Quantity	Schedule Date
10	Kanthal A1 strip(15x2mm) Heating Element Item: Kanthal A1 - Formed Heating Element - ready to use. For use in M/s Therelek make 10 to electric car bottom furnace. Element Details: 1. Material: Kanthal A1 grade 2. Cross section of the heating element (Width x Thickness) : 15mm x 2mm (rectangular) 3. Cutting Length of Element strip (before forming) : 21.2668 metre 4. Resistance of the element: 1.027184466 OHM 5. Power rating of the element: 25kW (230Vac, 108.70A) 6. Surface Load: 1.73W/sq.cm. 7. Weight of element with terminal: 5169 gram Forming Details of the Element: 1. Corrugation Height: 145mm 2. Pitch: 60mm 3. Radius: 14mm 4. No. of pitches: 66.42 5. Corrugated Length: 3985mm 6. Terminal detail: by joining 3 strips of 15x2mm Kanthal A1 strips. Note: Detailed drawing of the heating element(Drg No:TE 3544ELE) is attached for reference.	NO	2.000	2.00	30.04.16
20	Kanthal A1 wire(Ø4.8mm) Heating Element Item: Kanthal A1 - Formed Heating Element - ready to use. For use in M/s Vibrant make flux baking oven. Element Details: 1. Material: Kanthal A1 grade 2. Cross section of the heating element :dia 4.8mm wire 3. Power rating of the element: 7kW @230Vac(Star Connection) Forming Details of the Element: 1. Formation of element: By joining four coils in series. Each coil consist of 69 turns wound at a OD-33mm and pitch-10mm. The length of the coil is L690mm.	NO	3.000	3.00	30.04.16

The offers should reach us 30 minutes before the time of opening of tenders. The offers will be opened at 14.30 hrs on the due date of tender in the presence of tenderers who have submitted their offer and who may like to be present for the tender opening.Late and delayed offers are liable to be rejected.

Yours faithfully,  
For **BHARAT HEAVY ELECTRICALS LIMITED**

  
MANAGER / PURCHASE  
(FOSSIL BOILERS)  
By General Manager  
Purchase (CP & SP) / MM / RM  
BHEL, TIRUCHY - 620 014.



# BHARAT HEAVY ELECTRICALS LIMITED

( A Government of India Undertaking )  
HIGH PRESSURE BOILER PLANT  
PURCHASE DEPARTMENT - FOSSIL BOILERS  
THIRUCHIRAPALLI - 620014  
TAMILNADU (INDIA)

Page  
2/3

PHONE :2577938  
GRAMS : BHARATELEC  
FAX NO: 2520719  
E-mail: tvenkat@bheltry.co.in  
Web:

2661600085 / 29.02.2016

23505

2. Coil OD: 33mm
  3. No of turns per coil: 69
  4. Pitch of coiling: 10mm approx.
  5. Length of a coil: 690mm
  6. No of coil per element: 4
  7. Connection of coils in the element: series
  8. Terminal detail: Rod of SS310 material, L400mm (drawing will be provided)
- Note: Detailed drawing of the heating element(Drg No:014-01-03) is attached for reference.  
For Item SI Nos 10 & 20, detailed GA drawings of the heating elements (indicating terminal connections, dimensions, material composition etc) shall be furnished by the vendor along with the offer.

## General Note:

Important note:

'Documents submitted with the offer must be signed and stamped in each page by authorized representative of the bidder'

YOU SHOULD CONFIRM LD CLAUSE, VALIDITY, PAYMENT TERMS AND DELIVERY PERIOD AS PER BHEL COMMERCIAL TERMS AND CONDITIONS. OTHERWISE YOUR OFFER WILL BE REJECTED.

## ENCLOSURES

(i)ANNEXURE - 'A':- COMMERCIAL TERMS AND CONDITIONS MUST BE FILLED AND SUBMITTED ALONG WITH TECHNO COMMERCIAL BID.

(ii)ANNEXURE- 'V': CERTIFICATE BY CHARTERED ACCOUNTANT ON LETTER HEAD.

(iii) DRAWINGS - TE 3544ELE & 014-01-03

All the tenders may be addressed to the following address:

**The Tender Opening Cell / MM  
Room No: 26, Building 24, Ground Floor  
Bharat Heavy Electricals Limited  
TIRUCHIRAPALLI 620014**

In case personal delivery of the offer, it shall be dropped into the respective box kept in Room No: 26, after duly entering the data in the system.

Offers will be accepted only up to 14.00 Hrs on the due date. Therefore, vendors shall ensure to submit the offers well before this time. All due date extension requirements should be addressed to the respective

The offers should reach us 30 minutes before the time of opening of tenders. The offers will be opened at 14.30 hrs on the due date of tender in the presence of tenderers who have submitted their offer and who may like to be present for the tender opening. Late and delayed offers are liable to be rejected.

Yours faithfully,  
For BHARAT HEAVY ELECTRICALS LIMITED



MANAGER / PURCHASE  
D. CHANDRAMOHAN  
DY. General Manager

Purchase (GP & SP) / MM / RM  
BHEL, TIRUCHY - 620 014.



# BHARAT HEAVY ELECTRICALS LIMITED

( A Government of India Undertaking )  
HIGH PRESSURE BOILER PLANT  
PURCHASE DEPARTMENT - FOSSIL BOILERS  
THIRUCHIRAPALLI - 620014  
TAMILNADU (INDIA)

PHONE :2577938  
GRAMS : BHARATELEC  
FAX NO: 2520719  
E-mail: tvenkat@bheltry.co.in  
Web:

2661600085 / 29.02.2016

23505

Purchase mail IDs. All the due date extension requests from vendors will be considered only up to 48 hours before the due date and time.

Vendors are requested to avoid submission of offers through e mail / fax. In case of any unavoidable situation, offers shall be sent through e mail to the following mail ID only tender\_cell@bheltry.co.in.

As tenders are being opened by Common Tender Opening Cell, offer covers should be sealed with tenderer's distinctive seal and super scribed with correct Tender No. item of supply and due date of opening.

The offers will be opened at 14.30 hrs on the due date of the tender in the presence of tenderers who have submitted their offer and who may like to be present for the tender opening. Late and delayed offers are liable to be rejected.

The bidder along with its associate/ collaborators/ sub-contractors/ sub-vendors/ consultants/ service providers shall strictly adhere to BHEL fraud prevention policy displayed on BHEL website <http://www.bhel.com> and shall immediately bring to the notice of BHEL management about any fraud or suspected fraud as soon as it comes to their notice.

**Enclosures:**

"LD clause has to be confirmed without fail."

The offers should reach us 30 minutes before the time of opening of tenders. The offers will be opened at 14.30 hrs on the due date of tender in the presence of tenderers who have submitted their offer and who may like to be present for the tender opening. Late and delayed offers are liable to be rejected.

Yours faithfully,  
For BHARAT HEAVY ELECTRICALS LIMITED

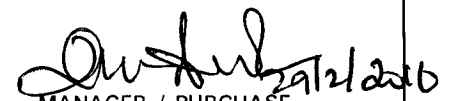
  
MANAGER / PURCHASE  
D. CHANDRAMOHAN  
Dy. General Manager  
Purchase (CP & SP) / MM / RM  
BHEL, TIRUCHY - 620 014.

Item Sk No. 157

# CAR BOTTOM FURNACE : ELEMENT DISTRIBUTION DETAILS

REVISED DATE SIGNATURE CHECKED

All dimensions are in millimeters

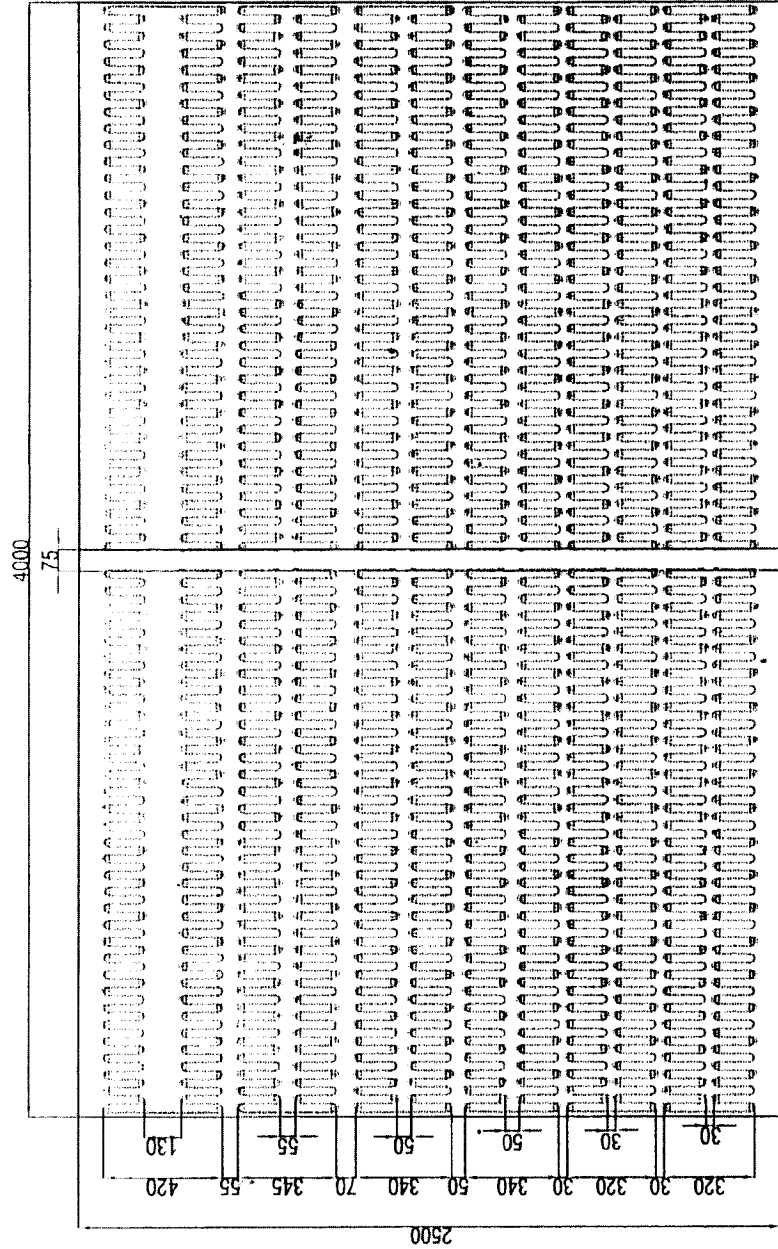

30 H = 8 NOS  
 50 H = 8 NOS  
 55 H = 4 NOS  
 130 H = 4 NOS

Total 24 NOS

Deepu Thomas  
 03/02/16

DEEPU THOMAS  
 Sr. Maintenance Engineer  
 Maintenance & Services  
 BHEL TRICHY - 620 014.



ELEMENT MATERIAL: KANTHAL A1 STRIPS  
 ELEMENT CROSS SECTION: 15x2 MM  
 CORRUGATION HEIGHT: 145 MM  
 PITCH: 60 MM  
 TERMINAL: BY JOINING 3 STRIPS OF 15x2, K-A1

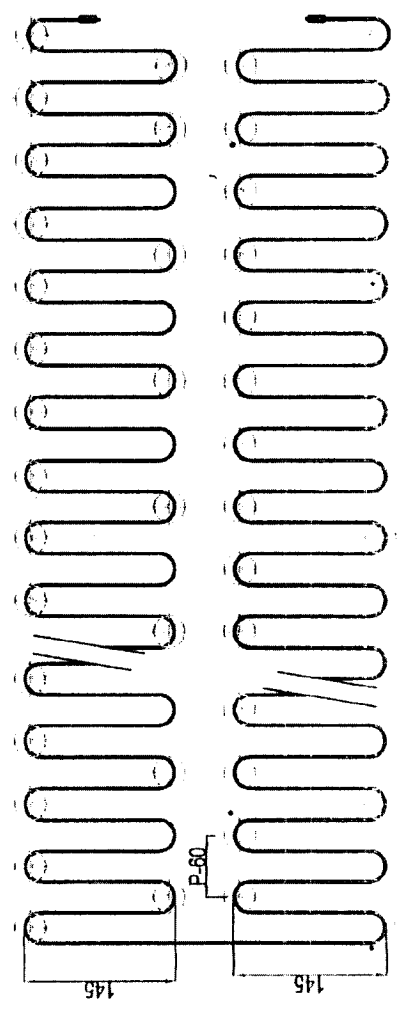

ELEMENT

Designed by	Approved by - date	File name	Date	Scale
		TE-3544 0	12-06-2007	NTS
ELEMENT DISTRIBUTION DETAILS				
CUSTOMER	M/S BHEL TRICHY	SHEET	1/1	REV NO
		DRG. No. TE 3544/ELE		1/1

29/12/2016

Item Sl No. 20

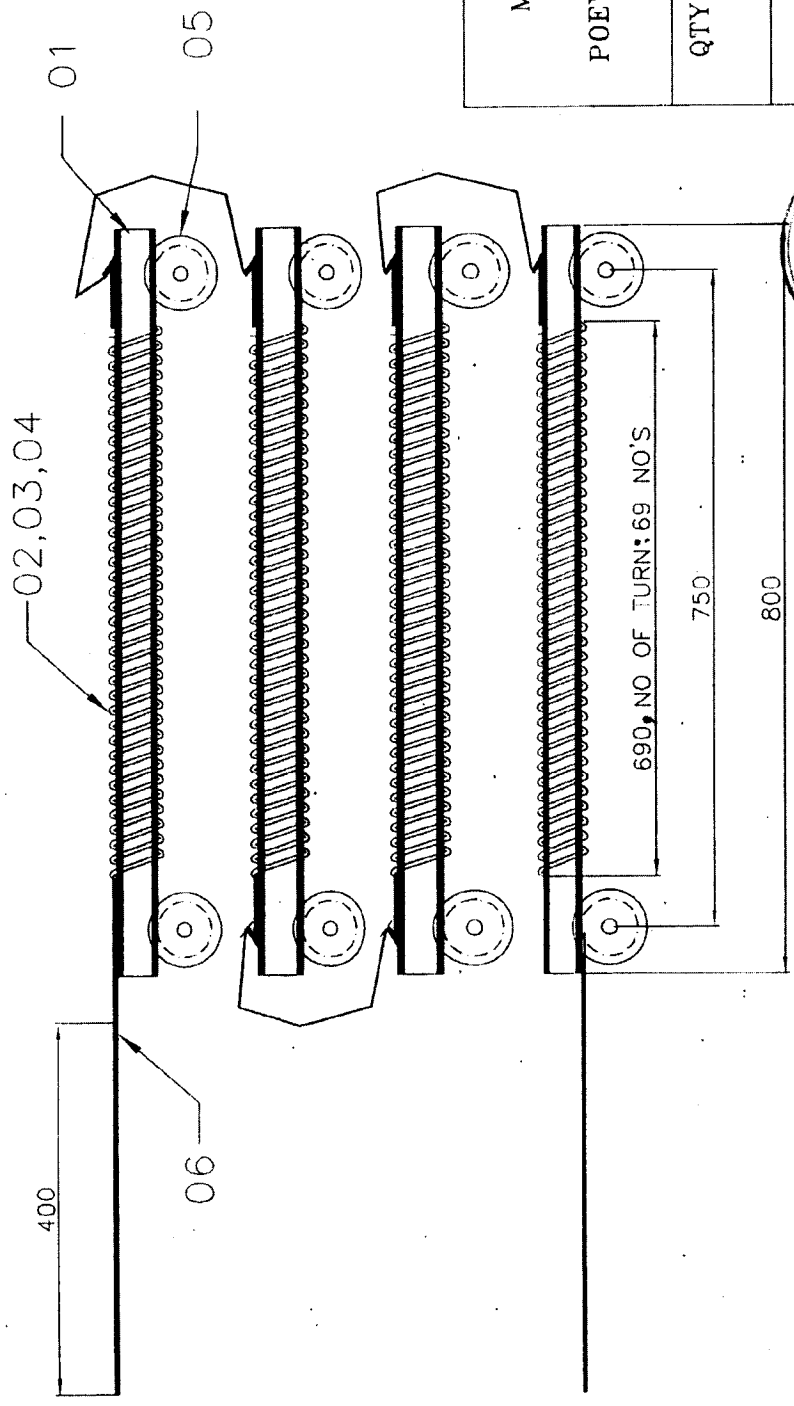

- 01. CERAMIC TUBE = OD22,L800
- 02. HEATING COIL = KANTHAL A1 GARDE
- 03. COIL OD = 33 MM
- 04. WIRE DIA = 4.8 MM
- 05. BOBIN
- 06. THERMINAL ROD

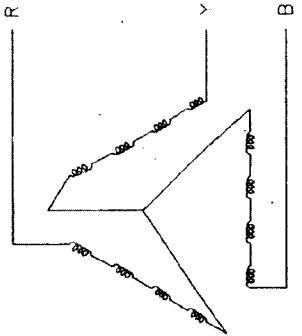

STARE CONNECTION

*Deepu Thomas*  
 6/3/2016  
**DEEPU THOMAS**  
 Sr. Maintenance Engineer  
 Maintenance & Services  
 BHEL, TRICHY - 620 014

MATERIAL = APM / A1
QTY :- 6 NO'S
POEWER : 6 X 7 = 42 KW
ONE FURNACE
QTY :- 6 + 6 = 12 NO'S
TWO FURNACE
QTY :- 4 NO'S
SPARE

NOTE  
 DESIGN & DIMENSIONS ARE SUBJECT TO  
 CHANGE DUE TO CONTINUOUS IMPROVEMENT

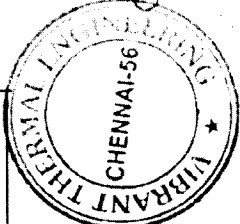

TITLE		HEATING HELEMENT DETAIL	
CLIENT		BHEL - TRICHY	
NAME	SIGN	DRAWING No.	REV
JN		014-01-03	00
DRN		SCALE	N.T.S
CHD	SV	TOTAL WT.Kg	-
APPD	SV	SHEET No	1
		No. OF SHEETS	3

*Dr. Anand 29/4/2016*

**BHARAT HEAVY ELECTRICALS LIMITED TIRUCHIRAPALLI**  
**CAPITAL PURCHASE**

Annexure-A

**PART - I**

**ACCEPTANCE OF COMMERCIAL TERMS AND CONDITIONS BY THE VENDORS.**

(This should be essentially filled in and sent along with the techno-commercial offer without fail. If this check list is not filled and submitted along with techno-commercial offer (Part I) or if the vendor does not confirm acceptance to the terms and conditions proposed herein, BHEL reserves the right to reject such offers)

**CHECK-LIST FOR INDIGENOUS VENDORS**

DESCRIPTION
<p>The Bidders shall submit their offer in <b>TWO INNER ENVELOPES</b> as indicated below which shall be sealed in one outer envelope.</p> <ul style="list-style-type: none"><li>❖ <b>Envelope I:</b> This sealed envelope should contain all the copies of technical bid together with un-priced commercial bid. This envelope should be clearly marked "<b>Part I - Technical and commercial bid</b>", indicating Enquiry No., Due Date and Address &amp; Reference of the Bidder.</li><li>❖ <b>Envelope II:</b> This sealed envelope should contain <b>price details</b>. This envelope should be clearly marked "<b>Part II - Price bid</b>", indicating Enquiry No., Due Date and Address &amp; Reference of the Bidder. This part should contain the schedule of price particulars and must be co-related to the technical details provided in Part I.</li></ul> <p>All the two envelopes (Part I&amp;II) shall be put in one cover, duly sealed, super scribing as "<b>Part I and Part II of Enquiry No., due date of opening</b>" and the address and reference of the Bidder. The offer received without the above guidelines, will not be considered for opening.</p> <p>The above offer should reach this office on or before the due date by 14.00 Hrs (IST). Late offers will not be considered.</p> <p>Tender should not be addressed to any Individual's name but only by designation to:</p> <ol style="list-style-type: none"><li>1) Please submit your offer on <b>F.O.R - BHEL, TRICHY</b> (Tamilnadu) basis and in two part (part-i: techno-commercial bid and part-ii: price bid) in a separate covers and both covers to be placed in an envelope which is super scribed with enquiry no, enquiry date and due date of tender opening.</li><li>2) If the offer is submitted in single part and the same will be liable for rejection.</li><li>3) All the Tenders may be addressed to the following address to <b>The Tender Opening Cell/MM</b> <b>Room No-26, Building – 24, Ground Floor</b> <b>Bharat Heavy Electrical Limited</b> <b>Tiruchirappalli- 620014.,</b> <b>TAMILNADU, INDIA</b></li><li>4) In case personal delivery of the offer, it shall be dropped into the respective box after duly entering the data in the system kept in room no. 26.</li><li>5) Offers will be accepted received till 14.00 hrs on the due date. Therefore Vendors shall ensure to submit the offers before this time.</li><li>6) Vendors are requested to avoid submission of offers thro email / fax. In case of any unavoidable situation, offers shall be sent thro email to the following mail ID only "<b>tender_cell@bheltry.co.in</b> "</li></ol> <p>Tenders should be free from <b>CORRECTIONS AND ERASURES</b>. Corrections if any, must be attested. All amounts shall be indicated both in words as well as in figures. In case of any difference between amount quoted in words and figures, amount quoted in words shall prevail.</p> <p>Offers should be in <b>ENGLISH</b> and accompanied by detailed technical literature, catalogue and detailed dimensional drawings in <b>ENGLISH</b> or otherwise, the offers will not be considered.</p>
<p><b><u>OPENING OF TENDERS</u></b></p> <p>The Part I- Technical &amp; commercial bid would be opened on the Tender opening date.</p> <p>Part-II, Price bid of technically suitable Bidders alone would be opened after complete evaluation of Part-I. Hence the Bidders are required to submit their best competitive price in the price bid in a sealed cover (Part-II).</p> <p>Date and time of Price Bid (Part-II) opening date shall be intimated to the technically and commercially acceptable bidders only. Clarifications if any required by BHEL for Technical evaluation would be sought from bidders before opening of Part II - Price Bid</p>



D. CHANDRAMOHAN  
Dy. General Manager  
Purchase (CP & SP) / MM / RM  
BHEL, TIRUCHY - 620 014.

**TAXES AND DUTIES :**

All Taxes and Duties payable as extra to the quoted price should be specifically stated in offers along with CST & TIN No / Tariff No. etc., failing which the purchaser will not be liable for payment of such Taxes and Duties. Our TIN No. 33243560005, TNGST No. 3560005, CST. No. 239383 Dt. 11-06-1991 & BHEL ECC No. AAACB4146PXM012, Service Tax Reg No (STC)- AAACB4146PST006. Assessment circle Tiruverambur.

**Cenvat credit & VAT credit** (for Indian Bidders only): If any Excise Duty is payable, the chapter head / sub-head reference and the rate of the duty should be quoted. If the tenderer is availing **CENVAT** credit for his input materials, the effect of Proforma credit should be passed on to the purchaser

**Income Tax applicable**

Any service charges payable towards supervision of E&C, training, performance prove-out etc., will be released after deduction of Income Tax as per Indian Income Tax Act / as per the Govt. of India rules and TDS certificate will be issued by BHEL for such deductions. Applicable service tax on E&C charges will be payable extra. The liability of depositing the same to the Govt. will be of the supplier

SL. NO.	<b><u>BHEL COMMERCIAL TERMS AND CONDITIONS FOR INDIGENOUS SUPPLIES</u></b>	Vendor's Confirmation / Comments
1	<b><u>Bid should be submitted in Two Parts.</u></b> 1. Techno-commercial Bid (Part-I) and 2. Price Bid (Part-II) in a separate sealed cover and both the covers must be placed in a Third Cover and Sealed. Our Enquiry No., Enq. Date & Enq. Due date must be written on all Three covers	
2	<b><u>ARBITRATION:</u></b> All disputes or differences whatsoever which may arise at any time during execution of the Contract shall be mutually settled by BHEL and Contractor as per provision of the Contract. However, in the event such disputes cannot be settled mutually, such disputes shall be settled as per the Arbitration and reconciliation Act, 1996 of the Govt. of India and it's subsequent amendments. In case of disputes with the Central PSUs, the same shall be settled at Tiruchirappalli as per the Guidelines of the Govt. of India.  However, during the period such disputes are settled either by mutual discussions between the parties or by legal means, Contractor shall continue to do the work as per terms & conditions of Contract.	
3	If offer is received from both OEM/Manufacturer and authorized dealers or Agent, then OEM/Manufacturer offer will only be considered and dealers or Agent offer will be ignored.	
4	Technical confirmation to BHEL's Specification shall be furnished. If needed additional sheets shall be used.	
5	Prices shall be quoted item wise only.	
6	Delivery INCO TERMS- Price quoted - <b><u>F.O.R - BHEL, TRICHY STORES</u></b> or ex-WORKS Basis or, FOR WORKS (DESPATCHING STATION) In case of EX works / FOR WORKS basis, indicate the Despatching station.  Prices shall be quoted on "FIRM PRICE" basis only.	
7	<b>Validity</b> of offer shall be for a minimum period of <b>120 days</b> from the date of Tender opening	
8	<b>Delivery period</b> from the date of Letter of Intent / Purchase order ( <b>write in DAYS/WEEKS</b> )	

*Director 29/12/2016*

9	<p><b>Liquidated damages</b> shall be 0.5% of the total order value per week or part thereof subject to a maximum of 10% of the total order value.</p> <p>For staggered delivery schedule, LD shall be 0.5% of the undelivered portion per week of the delay or part thereof subject to a maximum of 10% of the total order value.</p> <p><b>** In case of single delivery date , Order should be completed 100% for processing the bill, otherwise LD will be calculated based on Total PO Value restricted to Max % as mentioned in the PO Condition column.</b></p> <p><b>Material Despatched after Due date:</b> Once the delivery due date is crossed, <u>bills have to be clubbed till final despatch and forwarded for processing of payment as a single bunch.</u> LD percentage will be calculated from Delivery due date to final despatch date.</p> <p>For staggered delivery schedule, LD shall be 0.5% of the undelivered portion per week of the delay or part thereof subject to a maximum of 10% of the total order value.</p> <p><b>Any deviation from the above LD clause, loading will be applied to the extent to which it is not agreed by the bidder (at offered value).</b></p>	
10	<p><b><u>Payment term for supply portion:</u></b></p> <p>Payment term is <b>100% direct payment after 45 days</b> from the date of receipt and acceptance of materials.                  Note: Only Direct Payment after goods receipt &amp; acceptance will be accepted .Above payment term acceptance is essential for consideration of your offer</p> <p><b>Any deviation in the above payment term will attract loading as mentioned below. "Base rate of SBI (as applicable on the date of bid opening. Techno-commercial bid opening in case of two part bids) + 6% shall be considered for loading for the period of relaxation sought by bidders.</b></p> <p>Payment through Bank is not preferred. In case of Payment through Bank is opted by Supplier, BHEL prefers documents submission through bank with copy of LR and door delivery of Goods to Stores with Consignee copy attached. In this case Loading will be 3% on the offered value. Offers of indigenous Suppliers with payment terms as <u>LC/Advance Payment are liable for rejection.</u></p> <p><b>Important Note:</b> BHEL will consider the ranking after the loading is applied as referred vide Sl. No. 9 &amp;10 above wherever deviations are observed.</p>	
11	<p><b><u>Following Risk Purchase clause shall be applicable:</u></b></p> <p>The purchaser at his option will be entitled to terminate the contract and to purchase elsewhere at the risk and cost of the seller either the whole of the goods or any part which the supplier has failed to deliver or dispatch within the time stipulated or if the same were not available, the best and the nearest available substitute therefore. The supplier shall be liable for any loss which the Purchaser may sustain by reason of such risk purchases.</p>	
12	<p><b><u>Erection / commissioning: (if applicable only)</u></b></p> <p>Erection / commissioning charges if any has been mentioned in the offer or else confirmation that Erection / commissioning shall be done at free of cost is available in the offer.</p>	

*Signature* 29/12/2016

13	The equipment shall be guaranteed as per tender condition from the date of receipt & acceptance /(commissioning date ,if applicable as per tender condition). Normally No deviation permitted and the <u>deviated offers are liable for rejection.</u>											
14	Equipment will be inspected at vendor's works prior to dispatch if applicable. However final inspection and acceptance of equipment will be after installation at BHEL, Trichy and Tamilnadu.											
15	The vendor shall provide necessary drawings, Test Certificates and Operating Maintenance Manuals etc., as called for in the Technical Specification, in the required number of copies at no extra cost.											
16	Any warranty replacement during warranty period shall be supplied free of charge on FOR BHEL, Trichy, Tamilnadu basis.											
17	<p><b><u>MSME</u></b></p> <p>The bidder may also be a Micro and Small Enterprises (MSE) vendor registered as per MSE act. As per the public procurement policy notified by the Central government,</p> <p>20% of the tendered quantity is earmarked for MSE suppliers in this tender. Out of the 20% tendered quantity reserved for MSE suppliers, 4% shall be earmarked for procurement from MSE owned by SC / ST entrepreneurs. In case MSE vendor participating in the tender quotes within the price band of L1 + 15%, they will be allowed to supply the portion of the requirement subject to acceptance of L1 price by MSE vendor. In case of more than one such MSE, the supply shall be shared proportionately.</p> <p>"MSE suppliers can avail the intended benefits only if they submit along with the offer, attested copies of either EM II certificate having deemed validity (five years from the date of issue of acknowledgement in EM, II) or valid NSIC certificate or EM II certificate along with attested copy of a CA certificate (Format enclosed at Annexure -V where deemed validity of EM II certificate of five years has expired) applicable for the relevant financial year (latest audited). Date to be reckoned for determining the deemed validity will be the date of bid opening (Part I in case of two part bid). Non submission of such documents will lead to consideration of their bid at par with other bidders. No benefit shall be applicable for this enquiry if any deficiency in the above required documents are not submitted before price bid opening. <b>Documents should be notarized or attested by a Gazetted officer for consideration of MSE certificate.</b>"</p> <p><b><u>KINDLY FILL THE FOLLOWING BOX:</u></b></p> <table border="1" data-bbox="225 1429 1313 2024"> <tr> <td data-bbox="225 1429 746 1536">MSME Type (Please Tick the type of MSME) or Non-MSME</td> <td data-bbox="746 1429 1313 1536"><b>Micro / Small / Medium / Non-MSME</b></td> </tr> <tr> <td data-bbox="225 1536 746 1659">MSME Certificate no/Date (Details must be given) for MSME vendor. Certificate needs to be attached</td> <td data-bbox="746 1536 1313 1659"></td> </tr> <tr> <td data-bbox="225 1659 746 1798">Whether SC/ST (please tick the relevant category) ( Community Certificate issued by competent authority shall be attached)</td> <td data-bbox="746 1659 1313 1798"></td> </tr> <tr> <td data-bbox="225 1798 746 1890">If the Firm is SC/ST category, whether Proprietary or Partnership</td> <td data-bbox="746 1798 1313 1890"><b>Proprietary / Partnership</b></td> </tr> <tr> <td data-bbox="225 1890 746 2024">If partnership firm, % share held (Value must be entered)</td> <td data-bbox="746 1890 1313 2024"></td> </tr> </table>	MSME Type (Please Tick the type of MSME) or Non-MSME	<b>Micro / Small / Medium / Non-MSME</b>	MSME Certificate no/Date (Details must be given) for MSME vendor. Certificate needs to be attached		Whether SC/ST (please tick the relevant category) ( Community Certificate issued by competent authority shall be attached)		If the Firm is SC/ST category, whether Proprietary or Partnership	<b>Proprietary / Partnership</b>	If partnership firm, % share held (Value must be entered)		
MSME Type (Please Tick the type of MSME) or Non-MSME	<b>Micro / Small / Medium / Non-MSME</b>											
MSME Certificate no/Date (Details must be given) for MSME vendor. Certificate needs to be attached												
Whether SC/ST (please tick the relevant category) ( Community Certificate issued by competent authority shall be attached)												
If the Firm is SC/ST category, whether Proprietary or Partnership	<b>Proprietary / Partnership</b>											
If partnership firm, % share held (Value must be entered)												

*Handwritten signature and date: 29/12/2018*

<b>OTHER DETAILS REQUIRED</b>		
18	% of Excise Duty with cess (EXTRA / INCLUSIVE / NIL)	
19	% of TAX (VAT) (TNGST with FORM-17)	
20	% of TAX (VAT) without form	
21	% of TAX (CST) (CST with C-FORM)	
22	% of TAX (CST) without form	
23	Packing & Forwarding Charges ( in % only)	
24	Freight & transit insurance charges, if any(( in % only) Freight charges from Dispatching station to <b>BHEL, TRICHY (TN)</b> (Note: If the delivery terms is Ex Works the materials has to be sent through BHEL approved carrier only ,in this case the freight will be borne by BHEL)	
25	Approximate Net weight of the total consignment	
26	Approximate Gross weight of the total consignment	
27	Approximate Dimensions of the Consignment	
28	Name of the contact person	
29	Land Line Number	
30	Fax Number	
31	Mobile Number	
32	E-mail ID	
33	PAN No.	
34	CST No.	TIN No.

- a) It is confirmed that all the terms and conditions stipulated in the Enquiry have been fully understood by us and all clarifications & details have been obtained.
- b) Applicable % of ED, Sales Tax -CST or VAT, Service Tax), Freight, Insurance and Installation and Commissioning Charges etc., are indicated in offer.

Full postal Address:

Signature & Office Seal of the vendor

**Note:-**

Your specific acceptances to our Payment terms, LD & Risk Purchase (RP) Clause are essential for consideration of your offer. Otherwise your offer is liable for rejection.

No row shall be left blank. Please indicate NA, in case the item is “not applicable”

*Handwritten signature and date: 29/12/2016*

**D. CHANDRAMOHAN**  
Dy. General Manager  
Purchase (CP & SP) / MM / RM  
BHEL, TIRUCHY - 620 014.

**PART - II****MODEL PRICE BID FORMAT FOR INDIAN BIDDERS**

Enquiry No. &amp; Date:

Bidder's Offer No. &amp; Date:

Sl No	Description of item	Unit (SET /No)	QTY	Rate /Qty in Rs. (excluding of all taxes)	VAT/CST in % (TNGST with FORM-17 or CST with C-FORM)	ED in %	Service Tax in %	Total Value in Rs. (inclusive of all taxes)
	Packing & Forwarding charges (if any) in percentage (or) Lumpsum							
	FOR Dispatching station value in Rs.							
	Percentage of Freight & transit insurance charges, if any (Lumpsum or %) Freight & Insurance charges from Dispatching station <b>BHEL, TRICHY (TN)</b> (Note: If the delivery terms is Ex Works the materials has to be sent through BHEL approved carrier only, in this case the freight & Insurane will be borne by BHEL)							
	Approximate Net weight of the total consignment							
	Approximate Gross weight of the total consignment							
	Approximate Dimensions of the Consignment							

Signature &amp; Seal of Vendor

The price bid should be submitted only as per the above format. No row shall be left blank. Please indicate NA, in case the item is "not applicable"