



ಭಾರತ್ ಹೆವಿ ಎಲೆಕ್ಟ್ರಿಕಲ್ಸ್ ಲಿಮಿಟೆಡ್
भारत हेवी इलेक्ट्रिकल्स लिमिटेड

Bharat Heavy Electricals Limited

(A Government of India Undertaking)

ELECTRONICS DIVISION

P.B.No 2606, Mysore Road, Bangalore - 560 026
An ISO 9001, ISO 14001 & OHSAS 18001 Company

Gram : BHARATELEC
Telex : 0845-2436 BHCE IN
0845-8151 BHCE IN
Fax : 0091 80-26989219
RABMN : 40410000014
PHONE : +919449869655
E-MAIL : srinivasahb@bheledn.co.in

Addendum to RFQ: HBSBOS014 Dated 15.09.2014

RFQ Due Date: 08.10.2014

ITEM: Module Mounting Structures (MMS)

Project: 11.5 MW Solar Photo Voltaic Plant at NLC

Following revision/ modifications are incorporated in the specification:

A. Additional Evaluation Criteria:

“Price bids will be opened only for customer cleared bidders. Both manufacturer and installing contractor shall be approved by customer, M/S Neyveli Lignite Corporation Limited after acceptance of Part-1 (Techno-commercial) bid by M/s BHEL”

B. Due date is revised from 08.10.2014 to 13.10.2014.

All other terms and conditions of RFQ remain unchanged.

Sr.Manager (SC&PV/MM)

पंजीकृत कार्यालय : ' भेल हाउस ', सिरी फोर्ट , नई दिल्ली – 110 049
Regd. Office : BHEL House, Siri Fort, New Delhi – 110 049

Bharat Heavy Electricals Ltd
Electronics Division
Mysore Road, Bangalore – 560026

**Tender Document for SUPPLY, ERECTION &
CIVIL FOUNDATION WORKS OF MODULE
MOUNTING STRUCTURES (MMS)
RFQ REF: HBSBOS014**

Technical Bid Opening Date: 8th October, 2014

This Tender Document Contains:

General Terms and Conditions, Technical Specification, Unpriced Bid Formats & Price
Bid Formats

Note: Part – I: **To be submitted in a separate sealed cover**

Part – II: **To be submitted in a separate sealed cover.**

And Part-I & Part-II sealed covers should be put in outer envelope and super scribing the Name of work and Name & Address of the tenderer. Tender document should be dropped in Tender drop box super scribed “SC&PV-MM, Wednesday” kept in reception area of BHEL – EDN, Bangalore.

Contact Person at BHEL:

- 1. Mr. H.B. Srinivasa : Sr.Manager (SC&PV-MM)**
Ph: 080-26988495, Mob: 09449869655
Email:srinivasahb@bheledn.co.in
- 2. Ms. Mrinalini Gupta: Sr.Engineer (SC&PV-MM)**
Ph: 080-26998198
Email:mrinalinigupta@bheledn.co.in

REQUEST FOR QUOTATION

	BHARAT HEAVY ELECTRICALS LIMITED Electronics Division PB No. 2606, Mysore Road Bangalore - 560026 INDIA	RFQ NUMBER: HBSBOS014 RFQ DATE : 15.SEP.2014	Due Date 08.OCT.2014 Time: 13:00 HRS VENUE : NEW ENGG. BLDG
MMI:PU:RF:003			

(for all correspondence)

Purchase Executive : SRINIVAS H B
 Phone : 26998452
 Fax : 00918026989217
 E-mail: srinivasahb@bheledn.co.in

Please submit your lowest quotation subject to our terms and conditions attached for the material mentioned below. The quotation must be enclosed in a sealed envelope / Fax superscribed with RFQ no.and due date, should reach us on or before the due date by **13.00** hours IST and will be opened on the same day at **13.30** hours at the venue mentioned above. **PLEASE DROP THE OFFER IN THE BOX PROVIDED AT RECEPTION.**

RFQ TERMS & CONDITIONS:

- 1.Offer shall be submitted in two part :
 Part 1 : Techno-Commercial Bid
 Part 2 : Price Bid
2. This RFQ document comprises of :
 - (1) Request For Quotation
 - (2) Technical Specifications: PS- 439-914
 - (3) Enclosures B,B1&B2 : Commercial Terms & Conditions, Unpriced Bid Format and Price Bid Format
 - (4) General Terms and Conditions (Doc Ref : SCPV/BOS/01-Rev 01)
3. The delivery date indicated in RFQ is tentative. The actual delivery date shall be as indicated in Annexure B.
4. Unloading: Vendor's Scope

SI No.	Description	Qty	Unit	Delivery qty	Delivery Date
1	PS0679042539 Supply of MMS for 11.5MW NLC As per specs.PS-439-914 Test Certificate	1	ST	1	29.OCT.2014
2	PS0679042601 Erection of MMS & PV modules AT 11.5MW NLC As PER SPEC PS-439-914	1	AU	1	20.JAN.2015
3	PS0679043330 Civil foundation works for MMS AT 11.5MW NLC AS PER SPEC PS-439-914	1	AU	1	20.JAN.2015

Total Number of Items - 3

Please note that the tender will be opened in the presence of the bidders or his authorised representatives (maximum two per organisation) who choose to be present with authorisation letters. Refer annexure for the terms and conditions.

Please specify Terms of delivery, Excise duty, sales tax, Ex-BHEL, Ex-works surcharge, Insurance,P&F, Freight and other taxes very clearly .
 For evaluation,exchange rate(TT selling rate of SBI) as on scheduled date of tender opening (Part-I bid incase of two part bid) shall be considered.
 The offers of the bidders who are on the banned list as also the offer of the bidders, who engage the services of the banned firms, shall be rejected.The list of banned firms is available on BHEL web site www.bhel.com

- i). This is only RFQ not an order.
- ii). In all correspondence quote RFQ No. & due date.
- iii). In Quotation BHEL material code / RFQ Sl. No. should be mentioned clearly.
- iv). Quotation Envelope / Fax not superscribed with RFQ No.and due date is liable for rejection.
- v). Quotation should remain valid for a minimum peiod of 90 days from due date.
- vi). In case of non-receipt of Quotation or regret letter for 3 consecutive RFQs you are liable to be removed from our vendors list.
- vii). All Prices should be written in words and numbers.
- viii). Excise Chapter Heading should be mentioned for all items where VAT is applicable .

For and On behalf of BHEL.

Page 1 OF 1



PURCHASE SPECIFICATION, GROUP : PHOTOVOLTAICS
DESIGN, SUPPLY, ERECTION OF SOLAR PHOTOVOLTAIC (SPV) MODULE
MOUNTING STRUCTURES AND MOUNTING OF PV MODULES

PS-439-914

REV NO: 00

PAGE : 1 OF 11

COPYRIGHT AND CONFIDENTIAL



The information on this document is the property of Bharat Heavy Electricals Limited.

It must not be used directly or indirectly in anyway detrimental to the interest to the company

Technical Specification

For

**DESIGN, SUPPLY, ERECTION WITH CIVIL FOUNDATION WORKS OF SOLAR
PHOTOVOLTAIC (SPV) MODULE MOUNTING STRUCTURES AND MOUNTING OF PV
MODULES.**

Revision details :R 00	Prepared VCP 	Approved MS 	Date 05-09-2014
------------------------	--	---	--------------------

PV ENGG

	PURCHASE SPECIFICATION, GROUP : PHOTOVOLTAICS	PS-439-914
	DESIGN, SUPPLY, ERECTION OF SOLAR PHOTOVOLTAIC (SPV) MODULE MOUNTING STRUCTURES AND MOUNTING OF PV MODULES	REV NO: 00
		PAGE : 2 OF 11

1.0 Introduction

1.1 Bharat Heavy Electricals Limited (BHEL), Electronics Division, Bangalore is setting up Solar PV grid connected power plants for its customers.

1.2 This technical specification provides requirements for design, supply, erection of Solar photovoltaic (SPV) Module Mounting Structures and mounting of PV Modules. The scope includes design, making civil foundations for grouting the structures, erection of structures, module mounting and checking of alignment, tightness etc. at site. **This spec shall be read along with Annexures 1 and 2 relevant to the Solar Project site.**

1.3 Vendor shall visit site for evaluation of all the technical and operational requirements and familiarize himself with site conditions before participating in Tender.

1.4 Supply of solar Photovoltaic Modules will be within BHEL scope.

1.5 Technical documents included in the tender:

- (a) This technical / purchase specification
- (b) Annexure-1
- (c) Annexure-2 with project specific data
- (d) Drawings of PV module (As per applicable rating)
- (e) Technical specification for PV module (As per applicable rating)
- (f) Soil report or BHEL specified foundation dimensions and type
- (g) Proposed (indicative) solar array layout

Note: Type of structure, type of PV Module, quantity of modules and other project specific details shall be as per Annexure-2 attached.

2.0 Instructions to vendors for Bid submission:

2.1	Offer shall be submitted in two-parts (Two part-bid). Both parts shall be in separate sealed envelopes as per instructions in tender. The individual envelopes shall be enclosed in a common bigger envelope with markings (address, etc) on the envelope as per instructions provided in tender.
2.2	<p>First-part shall be techno-commercial bid. Following details shall be furnished:</p> <ol style="list-style-type: none"> 1. Details required for pre-qualification criteria as per Annexure-1 attached, including signed checklist. 2. Technical offer with covering letter. 3. Filled-up enclosures as per BHEL formats (meant for first-part) provided in tender. 4. Clause-wise compliance shall be filled-up in the column provided in this specification, with signature and seal on every page. 5. Company brochure especially with reference to structures and installations. 6. Audited balance sheets of the vendor company for the last 3 years. 7. Employee / manpower profile of the vendor company. 8. Details of solar array -Following table shall be filled up by the vendor.



1	Number of modules in each structure	
2	Number of vertical support legs per structure	
3	Module matrix per structure (e.g. 2x10)	
4	Module orientation	Portrait / Landscape
5	Direction of module facing	South
6	Distance of separation between the rows	
7	Distance between two structures within a row	
8	Total area (sq-m, acres) occupied	
9	Type of foundation (pile, ramming etc)	

9. Footprint of the structures, put together, in the form of a layout, fitting into the solar array area, as shown in the indicative BHEL drawing, shall be submitted. (**Note:** Electrical cabling layout for the PV array has been finalized based on the array layout attached. Vendors are advised to carefully go through the same and design accordingly). For this purpose, a separate drawing, as prepared by the vendor, showing solar array area with all the structures fitted within the boundary shall be submitted. The smallest structural unit shall be clearly brought out. BHEL drawing in A-Cad format shall be obtained by vendor by sending email request to contact email ID as given in the BHEL RFQ.
10. Drawing of foundation shall be furnished. Soil report or BHEL specified foundation dimensions and type for the site is enclosed as part of tender. More than one type of structure foundations may be required to be designed depending on the soil conditions at different locations in the site.
11. Design calculation for foundations and module mounting structure along with STAADPRO results.
12. Detailed drawings with bill of materials for structure.
13. Confirmation on supply of hardware spares.
14. List of machinery, tools & tackles, instruments etc that will be deployed at site shall be mentioned.
15. Stage-wise manpower plan shall be enclosed.
16. Time schedule shall be submitted.

2.3 Second-part shall be price bid with filled up enclosures as per BHEL format provided in tender.

2.4 In addition to the above instructions, tender document provides detailed instructions for bid submission. Vendor shall submit the bid based on instructions in tender document.



3.0 Technical specification

#	BHEL specification	Vendor compliance (Yes / No) In case of non-compliance or deviation, vendors shall record their comments:
3.1	Type of structure and angle of mounting as per Annexure-2	
3.2	Module facing direction as per Annexure-2	
3.3	<p>Solar array layout parameters as mentioned by the vendor in Clause 2.2(8) shall be selected based on the following considerations:</p> <p>(a) No. of modules to be interconnected in series to form string shall be as per Annexure-2. No. of modules per structure shall be integral multiples of no. modules per string.</p> <p>(b) Rows shall be, as much as possible, formulated to maintain multiplicity of specified number of modules in a series string.</p> <p>(c) Typical layout has been provided by BHEL. Vendor can propose changes as per the design of structures. The overall layout shall fit into the solar array area shown in the BHEL drawing, leaving sufficient space from plant boundary as per Annexure-2.</p> <p>(d) Distance between adjacent rows shall be so chosen to avoid shadow of the structure on the modules of back side row during the period 8:00 AM to 5:00 PM in any part of the year.</p> <p>(e) Shadow of Control room & Inverter Rooms as shown in enclosed layout drawing shall be considered before finalizing array layout. The typical height of the buildings above NGL is as per Annexure-2. Exact location of buildings will be finalized during detailed engineering.</p>	
3.4	<p>Load bearing structure material</p> <p>(a) Load bearing material shall essentially be made of steel with appropriate anti-corrosive finish such as GI etc. In case of GI, it shall be hot dip galvanized with minimum coating thickness as specified in Annexure-2. Galvanizing methods shall be in line with relevant IS standards.</p> <p>(b) These shall be made of standard hot rolled steel sections</p>	



	<p>as per IS 808 or cold formed sheet based components as per IS 811. Grade of steel: IS 2062-2011, E250 or higher.</p> <p>(c) Design shall take site conditions, soil report and design standards as per IS-875 (part-3), (K1=K2=K3=1) into consideration.</p>	
3.5	<p>Height of the structure shall be selected in such a way that the lowest level of the module plane shall have adequate minimum clearance above the ground level as specified in Annexure-2 to safeguard against floods, bushes etc.</p>	
3.6	<p>Hardware (required for foundations as well as mounting structures)</p> <p>(a) Bolts, nuts, screws, washers etc shall be of stainless steel SS304.</p> <p>(b) Foundation bolts (J-bolts), if applicable, shall be of GI with zinc plated finish of min. 15 microns (blue passivated) as per relevant standards.</p> <p>(c) Spring washers shall be with appropriate anti-corrosive finish (zinc coating etc) with adequate coating thickness as per relevant IS standards.</p> <p>(d) Hardware sizes shall be of adequate duty to withstand wind speed loads as specified in Annexure-2. Sizes of bolts, screws, nuts and washers shall be proportionate to one another based on relevant IS standards.</p>	
3.7	<p><u>Fastening torque</u></p> <p>(a) All fastenings, wherever applicable, shall be to a pre-determined torque value. Tools such as torque wrench etc shall be selected accordingly.</p> <p>(b) Wherever possible, electrically operated tools shall be employed to speed up the operations and to ensure accuracy.</p>	
3.8	<p>Suitable jigs, fixtures and templates shall be designed, fabricated and deployed at site for foundation, erection of structures, mounting of modules etc. Quantity of these shall be appropriate to ensure the required throughput per day. No. of templates/jigs planned shall be mentioned in the offer.</p>	
3.9	<p>Earthing will be in BHEL scope of supply. Provisions such as suitable holes etc shall be given in structure legs so as to facilitate earthing connections. BHEL will be forming earth grids by interconnecting the structures using suitable GI strips and earth electrodes.</p>	



3.10	Provision shall be made in the leg members/columns for mounting Array Junction Boxes and / or string monitoring boxes. The exact location of holes shall be finalized during drawing approval stage. Additional members required for mounting string monitoring boxes shall be in BHEL scope.	
3.11	Design calculations for foundations and module mounting structures along with drawings and BOQ shall be carried out using STAAD.pro software for specified wind velocity as per Annexure-2. Results shall be submitted to BHEL for approval along with bid. (MMS shall be with single column support only instead of front and rear supports so as to minimize civil works and erection time).	
3.12	In case of seasonal tilt type structures, mechanism for tilting shall be robust and suitable for manual operation applying minimum effort. Tools, tackles or jacks if any required for facilitating manual tilting shall be supplied in sufficient quantity so as to enable completion of tilting activity of all the structures in 3 weeks' time.	

4.0 Erection- vendor scope:

4.1	Marking of foundation positions Total stations of suitable accuracy of coordinates / directions, together with necessary accessories, instruments etc shall be deployed. Quantity of stations shall be appropriate to ensure the required throughput per day.	
4.2	Making foundations for structures (a) This includes all related activities such as excavation, drilling, assembly of steel rods with stirrups, mixing of concrete (M-25 grade), casting, curing, pedestal construction, finishing with paint etc - as shall be applicable depending upon the selected foundation type such as ramming, pile foundation, pedestals etc. (b) All materials related to foundations such as sand, cement, steel rods / stirrup wires, steel plates, stone jellies, bricks, concrete, J-bolts, nuts, bolts, washers etc shall be within the scope of vendor supply and hence, <u>shall be included in the offer as integral part of clause 3.0.</u> (c) Appropriate machinery, tools & tackles and measuring instruments for foundation works such as JCBs, drilling machines, ramming machines, concrete mixers, transport	



	trucks, transport trolleys, jigs / fixtures / templates (for positioning, alignment, shuttering etc), measuring tapes / scales, weighing machines, water level indicators, precision aligners (such as laser), spanners, pliers, torque wrenches, electrically / pneumatically operated screw drivers etc shall be deployed with adequate quantity to ensure the required throughput per day.	
4.3	Grouting of module structure legs ensuring suitable positioning accuracies.	
4.4	<u>Erection of steel structures including material movements, placing, assembly, fixing, tightening etc.</u> Cranes, hydra, forklifts, transport trucks, transport trolleys, jigs / fixtures / templates (for positioning, alignment etc), measuring tapes / scales, water level indicators, precision aligners (laser etc), spanners, torque wrenches, electrically / pneumatically operated screw driver sets etc shall be deployed with adequate quantity to ensure the required throughput per day.	
4.5	<u>Mounting of modules including module movements, placing, aligning, fixing, tightening etc.</u> Hydra, forklifts, transport trucks, transport trolleys, jigs / fixtures / templates (for positioning, alignment etc), measuring tapes / scales, precision aligners (laser etc), spanners, pliers, torque wrenches, electrically / pneumatically operated screw driver sets etc shall be deployed with adequate quantity to ensure required throughput per day.	
4.6	Foundations shall be provided with suitable painting finish.	

5.0 Documents to be submitted after receipt of purchase order for BHEL approval:

BHEL approval shall be obtained for the following technical documents, which shall be submitted within **seven** days from the date of purchase order:

5.1	Detailed solar array layout fitting within the boundaries of the solar array area shown in the proposed solar array layout drawing.	
5.2	Detailed drawings of foundations.	
5.3	Results of stability calculations for foundations and structural fitness of PV module mounting structures as per STADD Pro analysis.	



5.4	Shading analysis report showing the effect of shadow of various structures and buildings on the energy output of PV array.	
5.5	Detailed drawings of module mounting structures with bill of materials. BoM shall include item description, type, quantity, make, part / model number, specification etc.	
5.7	Results of design computations for solar module structures: Stress analysis, strength calculations, wind velocity withstand computations etc.	
5.8	Drawings of jigs, fixtures and templates for positioning / leveling alignment etc in foundation works .	
5.9	Drawings of jigs, fixtures and templates for positioning / leveling alignment etc in erection of mounting structures .	
5.10	Drawings of jigs, fixtures and templates for positioning / leveling alignment etc in module mounting works .	
5.11	List of sub-vendors for all the BoM items related to (a) foundations, (b) module mounting structures Note: Raw material for MMS shall be sourced from TATA steel or SAIL. Further, additional sources if required shall be proposed by vendor for approval by BHEL/ BHEL customer.	
5.12	List and quantity of total station and associated instruments and accessories for marking for foundation : Details of make, model number, features, accuracy of coordinates / directions, planned throughput per day, etc shall be submitted. Details of marking pins shall be mentioned.	
5.13	List and quantity of machinery, tools & tackles, measuring instruments for foundation works – JCBs, drilling machines, ramming machines, concrete mixers, transport trucks, transport trolleys, jigs / fixtures / templates, water level indicators, weighing machines, measuring tapes / scales, precision aligners (laser etc), spanners, pliers, torque wrenches, electrically / pneumatically operated screw drivers etc. Details of make, model number, planned throughput per day etc. shall be submitted.	
5.14	List and quantity of machinery, tools & tackles, measuring instruments for erection of mounting structures – cranes, hydra, forklifts, transport trucks, transport trolleys, jigs / fixtures / templates, measuring tapes / scales, water level indicators, precision aligners (laser etc), spanners, pliers, torque wrenches, electrically / pneumatically operated screw driver sets etc. Details of make, model number, planned throughput per day etc shall be submitted.	



5.15	List and quantity of machinery, tools & tackles, measuring instruments for module mounting works - hydra, forklifts, transport trucks, transport trolleys, jigs / fixtures / templates, measuring tapes / scales, precision aligners (laser etc), spanners, pliers, torque wrenches, electrically / pneumatically operated screw drivers etc. Details of make, model number, planned throughput per day etc shall be submitted.	
5.16	Working procedures and instructions for marking, foundation, erection of mounting structures and mounting of SPV modules.	
5.17	Detailed activity-time chart for project implementation.	
5.18	Detailed manpower deployment schedule.	

6.0 Pre-dispatch inspection of vendor supplied items

6.1	Vendor shall provide pre-dispatch inspection call to BHEL for inspection at manufacturer works, as per BHEL approved drawings, for all fabricated items such as steel structure members, galvanization process etc. Prior to inviting BHEL for pre-dispatch inspection, vendor shall submit detailed quality assurance plan (QAP) for BHEL approval. QAP shall include type tests, routine tests, factory acceptance tests, sampling plan, applicable standards etc. After the inspection, complete set of test reports shall be submitted.	
6.2	For all bought out items, test certificates as per relevant standards shall be submitted.	

7.0 Quality inspections at site

7.1	Prior to start of foundation and erection works at site, following shall be submitted to BHEL for approval: (1) QAP for marking / foundation / erection of structures / module mounting works at site. (2) Recording formats for the parameter values measured at site.	
7.2	Vendor shall submit filled-up recording formats and quality inspection reports periodically for BHEL approval.	
7.3	For any deviations, formal approval shall be obtained from BHEL before implementation.	



8.0 General conditions

8.1	Vendor shall construct their own site office for the purpose of overseeing and execution of the contract.	
8.2	Vendor shall, on their own, organize following infrastructure needed for the construction at their own expenses: (a) Power supply required. In case DG sets etc are required, the same shall be organized by the vendor. (b) Water required for activities such as foundations, concrete mixtures etc. (by tankers if required) shall be organized by the vendor. (c) All the machinery such as cranes, hydra, JCBs, forklifts, tools & tackles, measuring instruments etc for various activities such as unloading of materials at site, movement of materials, foundation, erection of structures, module mounting, etc shall be organized by the vendor. (d) Labour required for unloading of vendor materials at site, movement of materials, construction activities etc shall be organized by the vendor.	
8.3	Delivery of all the materials related to foundations such as sand, bricks, cement, steel rods / stirrup wires, steel plates, stone jellies, concrete, J-bolts, nuts, bolts, washers etc. to site shall be done as per the project schedule requirement.	
8.4	Vendor shall construct their own storage area at the site with appropriate fencing, roofing, gate, lock and key arrangements to store and safeguard their items against rain, flood, fire etc.	
8.5	Safeguarding the vendor supplied materials from theft and pilferage is the responsibility of vendor. For this purpose, necessary security watch and ward, on round the clock basis, shall be arranged by vendor.	
8.6	Insurance for all vendor supplied items shall be within scope of vendor, as applicable until the point of time when the erection is completed in all respect and handed over to BHEL.	
8.7	Vendor shall make their own arrangements for necessary food, drinking water and accommodation for their labour and employees posted at the site. Similarly, food and drinking water required at the site, during the construction operations, shall also be in scope of vendor.	



8.8	Vendor shall organize their own labour, machineries, tools and tackles required for unloading, safe storage and security for the BHEL make SPV modules at suitable location near to site. The location for storage of PV modules shall be finalized based on acceptance by BHEL. This clause is applicable only to some projects. Vendor shall refer Annexure-2 for applicability of this clause for particular project. Vendor shall understand the contents of Annexure-2 and quote accordingly.	
8.9	Vendor shall organize their own labour for transport arrangements to move the BHEL make SPV modules from the storage locations to the construction point at the site. Storage location shall be very close to the site. Vendor shall carry out such movements only with prior permission from BHEL authorities at the site.	
8.10	Vendor shall organize all necessary labour-related statutory requirements such as labour license, PF, ESI, insurance etc.	
8.11	Vendor shall maintain updated labour register, with name, age, qualification, salary, attendance details etc at the site.	
8.12	Vendor shall use danger boards, wherever required, to ensure safety of the persons during the work at site.	
8.13	Vendor shall adhere to all necessary safety norms such as use of helmet, goggles, hand gloves, footwear, aprons etc. It is the ultimate responsibility of the vendor in all respect to prevent accidents at the site and safeguard their labour from accidents.	
8.14	Vendor shall submit periodic status report, on daily basis as well as weekly consolidated basis, to BHEL on the progress of the contract.	

	ANNEXURE – 1 TO PS-439-914	
	DESIGN, SUPPLY, ERECTION OF SOLAR PHOTOVOLTAIC (SPV) MODULE MOUNTING STRUCTURES AND MOUNTING OF PV MODULES	
		PAGE : 1 OF 3

SITE: NEYVELI LIGNITE CORPORATION (NLC) 11.5 MW Solar PV Plant

1.0 Pre-qualification criteria (PQC) for vendors bidding for Design, Supply, Erection with Civil Foundation works of Solar PV MMS and mounting of PV modules .

Vendor shall read the following criteria carefully and furnish the necessary details. For this, vendor shall fill up the RFQ check list under section 5 with signature, seal and date.

1.1 Vendor should have completed the design, supply and erection of a minimum of 5 MWp ground mounted solar photovoltaic (SPV) module mounting structures for SPV projects in India in last 2 years from the date of opening of the bid, with individual PV plants of 1 MW and above. Evidence shall be furnished in the form of copies of purchase orders or completion certificates. In case, if the vendor has taken any external support of other agencies for any of the activities (Design, supply, erection of MMS) complete details of the same shall be furnished viz. a) Name of the external agency b) work or job allocated to the external agency c) evidence of the tie up with external agency.

1.2 Vendor shall also provide a list of design, supply and erection of module mounting structures of various types for SPV projects in India during the last two years. The list shall include details such as site location, year of erection, client name, MW size of power plant, type of structures, number of units etc. This list is only for reference. However, providing this list is mandatory as part of pre-qualification criteria.

1.3 Vendor shall be a registered company in India. Necessary evidence for this shall be submitted.

1.4 BHEL has floated similar RFQs for MMS of various solar projects together, for which the value of the Solvency is mentioned against each RFQ. The Certificate of Solvency shall be total of all individual Solvency values, if the bidder is participating in more than one RFQ including this RFQ. Vendor shall clearly mention the project for which the Solvency Certificate is intended. In absence of clarity of applicability of Solvency Certificate project-wise, BHEL shall exercise its decision for acceptance of the Solvency Certificate towards particular RFQ out of the multiple RFQ bids submitted by the bidder. The table given below gives details of Solvency certificate values for RFQs of BHEL for other Solar Projects being executed simultaneously.

BHEL Project details	Solvency value in Rs. (rounded off)
Diu 3 MW	1,32,00,000/-
Daman 1 MW	51,00,000/-
Dadra Nagar Haveli 3 MW	1,26,00,000/-

	ANNEXURE – 1 TO PS-439-914	
	DESIGN, SUPPLY, ERECTION OF SOLAR PHOTOVOLTAIC (SPV) MODULE MOUNTING STRUCTURES AND MOUNTING OF PV MODULES	
		PAGE : 2 OF 3

OPCL 3.42 MW	1,32,00,000/-
BHEL RC Puram 1.5 MW	78,00,000/-
KPCL 10 MW	2,63,00,000/-
NLC 11.5 MW	4,32,00,000/-

2.0 FINANCIAL STATUS EVALUATION:

Vendors shall furnish the **solvency certificate issued by bankers, with date of issue not before 3 months of tender opening date** for minimum worth of the value mentioned in PQC as below.

If vendor is participating in **more than one of the RFQ's/tenders** of BHEL for supply and erection of MMS, value of such **solvency certificate shall commensurate with cumulative PQC value worth.(i.e. total sum of all the solvency values for the RFQs being quoted)**.

Solvency value:

BHEL Project details	Solvency value in Rs.
NLC 11.5 MW	4,32,00,000/-

3.0 EVALUATION OF CAPACITY OF FABRICATION:

Vendors shall furnish a declaration for approximate capacity of steel tonnage for manufacturing the MMS for the specified PV project as per value mentioned below. Actual supply is subject to actual weight of the approved design as per site condition.

BHEL Project details	Approximate estimated Tons of MMS to be manufactured and handled within scheduled Project period
NLC 11.5 MW	748

Vendor shall demonstrate through **the declaration** by the way of PO/Certificate of completion by customers **from fabricator/ external support agency** that they are able to supply the fabricated materials of quantity required for each of the project **within 10 weeks** of Proto type/sample clearance for mass production. BHEL reserves right to verify.

	ANNEXURE – 1 TO PS-439-914	
	DESIGN, SUPPLY, ERECTION OF SOLAR PHOTOVOLTAIC (SPV) MODULE MOUNTING STRUCTURES AND MOUNTING OF PV MODULES	
		PAGE : 3 OF 3

Vendors participating applying for **more than one RFQ's shall demonstrate** through the declaration by fabricator/ external support agency for the strength/capability of supply of the fabricated MMS **to the extent of cumulative quantity for MT of steel for MMS they are quoting within 12 weeks** of Proto type/sample clearance for mass production. BHEL reserves right to verify.

4.0 EVALUATION OF CAPACITY FOR EXECUTION OF CIVIL FOUNDATION WORKS :

Vendor shall demonstrate through the **declaration** by the way of PO/Certificate of completion by customers **that they or their Civil agency/ external support agency is able to design, complete parallel civil activity** with required **materials and machines for each** of the projects bid for , **within 12 weeks** of Proto type/sample clearance for mass production. BHEL reserves right to verify.

5.0 Checklist for Pre-Qualification-Criteria:

(a)	PQC clause 1.1	Have the evidence documents – PO copies and client certificates - been enclosed? (For design, supply, erection of SPV module mounting structures for a minimum of 1MWp SPV projects in last 2 years as per PQC clauses	Yes / No
(b)	PQC clause 1.2	Has the list of design, supply, erection of module mounting structures in India for last two years, with particulars, as per PQC clauses been enclosed?	Yes / No
(c)	PQC clause 1.3	Have evidences for the vendor as registered companies in India been enclosed, as per clauses?	Yes / No
(d)	PQC clause 2.0	Has Solvency Certificate from bank submitted commensurate with the RFQs being quoted for?	Yes / No
(e)	PQC clause 3.0	Has Certificate/evidence submitted for Capacity of fabrication commensurate with the RFQs being quoted for?	Yes / No
(f)	PQC clause 4.0	Has Certificate/evidence submitted for execution of Design and Civil foundation works commensurate with the RFQs being quoted for?	Yes / No

Note: Failure to comply with PQC as per clause 5.0 as evidenced in the responses to the checklist above will result in rejection of bid.

Signature, seal and Date of the bidder

	ANNEXURE - 2 TO PS-439-914	
	DESIGN, SUPPLY, ERECTION OF SOLAR PHOTOVOLTAIC (SPV) MODULE MOUNTING STRUCTURES AND MOUNTING OF PV MODULES	
		PAGE : 1 OF 2

1.0 Introduction:

Bharat Heavy Electricals Limited (BHEL), Electronics Division, Bangalore is setting up 11.5 MWp Grid-connected SPV Power Plants at NEYVELI LIGNITE CORPORATION (NLC). This annexure specifies the project specific requirements of this project.

2.0 Power plant configuration

A brief summary of the power plant is provided here below so as to enable the vendors to select and offer appropriate type of structures.

The 11.5MWp solar photovoltaic power plant at NEYVELI LIGNITE CORPORATION (NLC) shall have a solar array with fixed type of structures. PV modules of mono-crystalline type of rating 240Wp min will be deployed. The solar array will also have 140 numbers of string monitoring units (SMUs) and 140 numbers array junction boxes (AJBs) that collect the solar PV generated DC power. These string monitoring boxes shall be installed below the PV modules with the support of columns/leg members of Module mounting structure.

3.0 Technical parameters:

SL. No	Parameter	Specification
1	Type of Structure, angle of inclination	Galvanized steel, seasonal tilt (Manual) at 0°, 11° and 26°
2	Makes of steel	Tata/ SAIL or other source based on approval by customer.
3	Module Type and wattage	240Wp min
4	Total No. of Modules	48000 Nos.
5	No of Modules in series per string	24
6	Module orientation	Portrait (2-tier)
7	Direction of module facing	South facing
8	Coordinates of site location	11.6°N, 79.5°E
9	Height of the lowest part of modules mounted on structure from the ground	400 mm
10	Galvanization thickness in microns (minimum)	80 microns
11	Design wind speed KMPH (min.)	160 KMPH with factor of safety for structure design (min.)= 1.5, Seismic condition : Zone-II as per IS:1893

	ANNEXURE - 2 TO PS-439-914	
	DESIGN, SUPPLY, ERECTION OF SOLAR PHOTOVOLTAIC (SPV) MODULE MOUNTING STRUCTURES AND MOUNTING OF PV MODULES	
		PAGE : 2 OF 2

12	No of SMUs to be mounted on Structures	140 Nos. SMUs and 140 Nos. AJBs
13	Clearance required from boundary of the plant to PV array	13m Approx.
14	Height of control room/ inverter room building from ground level (Tentative)	5m
15	Unloading and safe storage of BHEL supplied PV Modules as per Clause 10.8 of PS-439-914 is in vendor's scope	No
16	No. of Spare structures to be supplied (full set)	10 sets

Bidder's Signature with seal and date

08500 02 679 3
DRAWING NO. ON DRAWING

COPYRIGHT AND CONFIDENTIAL
The information on this document is the property of Bharat Heavy Electricals Limited. It must not be used directly or indirectly in anyway detrimental to the interest of the Company

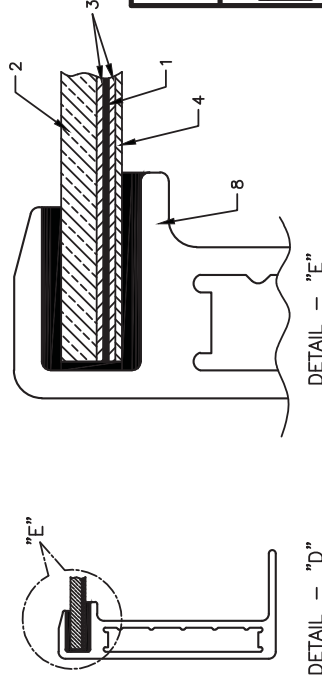
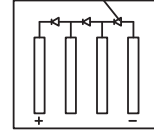
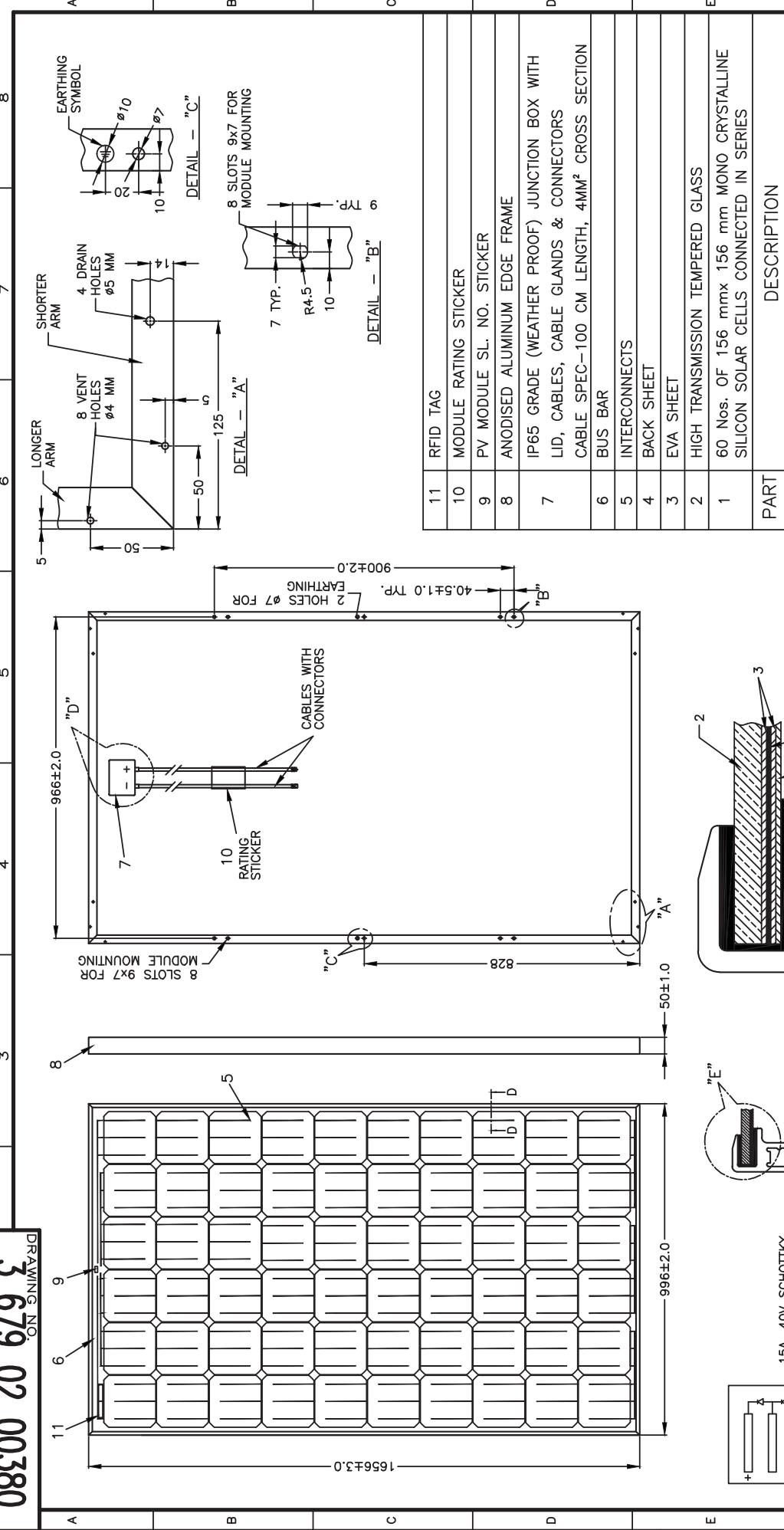

RFID TAG	MODULE RATING STICKER	PV MODULE SL. NO. STICKER	ANODISED ALUMINIUM EDGE FRAME	IP65 GRADE (WEATHER PROOF) JUNCTION BOX WITH LID, CABLES, CABLE GLANDS & CONNECTORS	CABLE SPEC-100 CM LENGTH, 4MM ² CROSS SECTION	BUS BAR	INTERCONNECTS	BACK SHEET	EVA SHEET	HIGH TRANSMISSION TEMPERED GLASS	60 Nos. OF 156 mmx 156 mm MONO CRYSTALLINE SILICON SOLAR CELLS CONNECTED IN SERIES
11	10	9	8	7	6	5	4	3	2	1	

REF. DRG. NO.

SIGN & DATE

INVENTORY NO.

TYPE OF PRODUCT OR NAME OF CUSTOMER/PROJECT

DEPT. SC&PV	FOR UNSPECIFIED-TOLERANCES	SCALE	WEIGHT(Kg)	REF. TO ASSY. DRG.	ITEM NO.	No. OF ITEM
439	REFER ED 0230499	1 : 10				

BHARAT HEAVY ELECTRICALS LIMITED.
ELECTRONICS DIVISION, BANGALORE

REV.	DATE	ALTERED	CHECKED	APPROVED	SR	REV.	DATE	SIGN.	NAME	DRN	DATE	No. OF VAR
01	100714	CHECKED	SM	APPROVED	SR	00				SAN	120614	Sd/-
		APPROVED								NAR	120614	Sd/-
										SR	120614	Sd/-

DRAWING NO. **3 679 02 00380**
PHOTOVOLTIC MODULE-L20220
156mm Mono Solar Cell (Corner Block Type)

SHEET NO. 01 NO. OF SHEETS 01



**PRODUCT STANDARD
ELECTRONICS DIVISION**

CD-4-4001-123

REV. 00

A4-10

PAGE 01 OF 01

TECHNICAL SPECIFICATION FOR PV MODULE L20220 (20 V, 240 WATTS)

- 1. PV MODULE TYPE NO. : L20220
- 2. CONFIGURATION : SINGLE GLASS LAMINATED TYPE WITH 60 NOS. OF 156-mm MONO CRYSTALLINE SILICON SOLAR CELLS (10*6) IN SERIES CONFIGURATION.
- 3. OVERALL SIZE : 1656 (±3) * 996 (±2) * 50 (±1) mm
- 4. WEIGHT : 20 Kg. (Typ.)
- 5. PV MODULE FRAME MATERIAL : ANODISED ALUMINIUM
- 6. JUNCTION BOX : IP65 GRADE JUNCTION BOX WITH CABLES AND CONNECTORS
- 7. RFID Tag : As per JNN SM Guidelines (Pasted on the backside of the PV Module)
- 8. TYPICAL ELECTRICAL CHARACTERISTICS:
 - 8.1 OPEN CIRCUIT VOLTAGE (Voc) : 36.0 V
 - 8.2 SHORT CIRCUIT CURRENT (Isc) : 8.5 A
 - 8.3 VOLTAGE AT PEAK POWER POINT (Vmp) : 29 V
 - 8.4 CURRENT AT PEAK POWER POINT (Imp) : 8.28 A
 - 8.5 PEAK POWER OUTPUT (Pmax.) : 240 W (minimum)
 - 8.6 MODULE EFFICIENCY : 14.55 %
 - 8.7 CELL EFFICIENCY (@ Module level) : 16.7 %
 - 8.8 FILL FACTOR : 0.70

NOTE :

- 1. Electrical specifications mentioned above are at Standard Test Conditions of 100 mW/sq. cm solar insolation (AM 1.5) and at 25 deg C temperature.
- 2. Measurement repeatability of peak power output: ± 3 %

COPY RIGHT AND CONFIDENTIAL

The information on this document is the property of Bharat Heavy Electrical Limited. It must not be used directly or indirectly in any way detrimental to the interest of the company.

Rev (00)

APPROVED BY:

SR

PREPARED

SM
[Signature]

ISSUED

Engg.

DATE

18.07.2014

**CONDUCTING SOIL TESTING & INVESTIGATION
AT 10 MW SPV POWER PLANT FOR NEYVELI LIGNITE
CORPORATION LTD, NEYVELI, TAMIL NADU.**

CLIENT

**BHARAT HEAVY ELECTRICALS LIMITED
BANGALORE**

TITLE

INTERIM REPORT

REPORT NO: SI/CHN/14/1204 /01

SEPTEMBER 2014



GEO FOUNDATIONS & STRUCTURES PVT LTD

3/2, RAMS, No.89, I Main Road, Gandhi Nagar, Adyar,

Chennai – 600 020. Ph: 044 – 24431462, 24430399

Website: www.geofoundations.net

Email: geogfs@gmail.com

CONTENTS

	Page No.
1) Introduction	1
2) Scope of work	1-2
3) Field investigations-geo Technical Studies	2-3
4) Ground Water Level	3

APPENDIX

APPENDIX – I Bore logs	4-15
------------------------	------

★ ★ ★ ★ ★ ★ ★

INTERIM REPORT

1. INTRODUCTION

This interim report deals with the soil investigation work carried out at 10 MW SPV Power Plant for Neyveli Lignite Corporation Ltd, Neyveli, Tamil Nadu, for Bharat Heavy Electricals Limited, Bangalore.

2. SCOPE OF WORK

Drilling **ten** bore holes of 150 mm diameter up to 6 m and **one** bore hole of 150 mm diameter up to 20 m, conducting field and laboratory test on the soil samples and recommendations for suitable type of foundation for the proposed structure.

The scope of work at this site comprised the following:

- 2.1 Mobilization of boring rig with all necessary equipments and personnel.
- 2.2 Boring of eleven bore-holes in the project site with calyx power drilling equipments through sand, silt, clay etc. to a maximum depth of 20 m. The boring was carried out at locations indicated in drawing BH-NLC-046-C-DRG.
- 2.3 Conducting Standard Penetration Tests in the bore-holes and collecting disturbed and undisturbed soil samples including packing and transportation to laboratory.
- 2.4 To conduct the following laboratory tests on soil samples:

(a) Particle size analysis:

- (i) Sieve analysis

(b) Index properties:

- (i) Liquid limit
- (ii) Plastic limit
- (iii) Free swell index

- (c) Dry & wet density
- (d) Water content
- (e) Specific gravity and Void ratio
- (f) Shrinkage limit
- (g) Swell pressure
- (h) Direct shear test
- (i) Tri-axial shear test
- (j) Unconfined Compressive strength test
- (k) Chemical analysis on soil & water samples
- (l) CBR Tests.
- (m) Moisture content,
- (n) Specific gravity of rock samples

2.5 Conducting eleven numbers of Electrical Resistivity tests.

2.6 Recording ground water table level.

Preparation and submitting detailed report with field and laboratory results and recommendations for foundations.

3. FIELD INVESTIGATIONS

- 3.1 Boring rig with all requisite equipments and accessories were mobilized at the work site in August 2014. A team of technical personnel with skilled labours were deployed.
- 3.2 Eleven bore holes were bored to a maximum depth of 20 m below the existing ground level as per **IS: 1892- 1979**.
- 3.3 Eleven Electrical Resistivity tests were conducted as per **IS 3043-1987**.
- 3.4 Disturbed samples were collected at every change of strata or about 1.50 meters depth intervals up to termination depth. The samples so collected were sealed

and numbered with full particulars for identification and sent to the laboratory for conducting the required tests.

- 3.5 Standard Penetration Tests were conducted in the bore- holes at intervals of 1.50 m as per **IS: 2131-1981**. In this test, the standard split spoon sampler is driven into the ground at the required depth by means of standard hammer of 63.5 kgs weight; falling from a height of 75 cm. Number of blows for the first 15 cm is not taken into consideration because of possible disturbances or presence of settled suspended matters at the bottom of the bore- holes. The total number of blows for the next 30 cm depth of penetration is considered as SPT 'N' values are shown in Figs 1 to 11.
- 3.6 Detailed report with all lab tests and field tests will be produced at the time of submission of draft report.

4.0. GROUND WATER TABLE.

Ground water table was met at a depth of **1.85 m to 4.20 m** during the boring from **12.08.2014 to 20.08.2014**.

For GEO FOUNDATIONS & STRUCTURES PVT. LTD.

A.Suresh Kumar, M.Tech. (Geo Technical).





D.G.M. (Geo Technical).

APPROVED BY,

**Dr. K. Muthukrishnaiah BE(Hons), M.Tech., Ph.D.,
(Professor & Head, Ocean Engineering Dept. IIT Madras)(Rtd),
(Chief Consultant)**

Project : Conducting Soil Testing & Investigation at 10 MWp Solar PV Power Plant at Neyveli Lignite Corporation Ltd Neyveli, Cuddalore Dist, Tamil Nadu.

 GEO FOUNDATIONS & STRUCTURES PVT. LTD	Location : Neyveli		Drillhole Record - BH 1		
	Bore Hole No : BH-1		Fig No.1		
	Reduced Level : 51.56		Coordinates	X	338415.983
	Type of Boring : Calyx			Y	1283910.010
	Ground Water Level : Not met with		Start Date : 17.08.2014		
Termination Depth : 6.0 m		End Date : 17.08.2014			

VISUAL SOIL DESCRIPTION	COLOUR	STRUCTURE	REDUCED LEVEL (m)	LEGEND	TEST NO	SAMPLE TYPE	DEPTH FROM G.L (m)	TEST DEPTH(m)	PENETRATION VALUES			SPT 'N' Blows/300mm	SPT 'N' PROFILE					C.R (%)	R.Q.D(%)	REMARKS	
									15cm	30cm	45cm		20	40	60	80	100				
Clayey SAND	Red	Loose, Granular	49.56		SPT-1	SS	1.50	1.50-1.95	3	4	6	10									
Silty CLAY	Red	Stiff, Layered	47.06		UDS-1	SS	2.00	2.00-2.45	-	-	-	-									
		Very Stiff, Layered			SPT-2	SS	3.00	3.00-3.45	5	7	11	18									
Clayey SAND	Red	Medium Dens, Granular	45.56		SPT-3	SS	4.50	4.50-4.95	8	9	12	21									
Reddish, Hard, Sandy CLAY			45.56		SPT-4	SS	6.00	6.00-6.45	17	20	27	47									
G.W.L on : Not met with			No. of. SPT	4 nos		No.of.UDS	1 Nos		REMARKS												

Note: SPT-Standard Penetration Test SS-Soil Sample.

UDS-Un Disturbed Sample CS-Core Sample

CR-Core Recovery , RQD-Rock Quality Designation

Project : Conducting Soil Testing & Investigation at 10 MWp Solar PV Power Plant at Neyveli Lignite Corporation Ltd Neyveli, Cuddalore Dist, Tamil Nadu.

 GEO FOUNDATIONS & STRUCTURES PVT. LTD	Location : Neyveli		Drillhole Record - BH 2		
	Bore Hole No : BH-2		Fig No.2		
	Reduced Level : 50.735		Coordinates	X	338517.964
	Type of Boring : Calyx			Y	1283879.484
	Ground Water Level : Not met with		Start Date : 19.08.2014		
Termination Depth : 6.0 m		End Date : 19.08.2014			

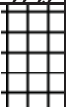
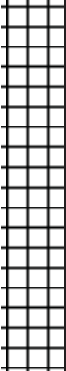
VISUAL SOIL DESCRIPTION	COLOUR	STRUCTURE	REDUCED LEVEL (m)	LEGEND	TEST NO	SAMPLE TYPE	DEPTH FROM G.L (m)	TEST DEPTH(m)	PENETRATION VALUES				SPT 'N' Blows/300mm	SPT 'N' PROFILE					C.R (%)	R.Q.D(%)	REMARKS				
									15cm	30cm	45cm			20	40	60	80	100							
Clayey SAND	Red	Medium Dense, Granular	48.735		SPT-1	SS	1.50	1.50-1.95	3	4	7	11													
Sandy CLAY	Red	Stiff, Layered	47.735		UDS-1	SS	2.00	2.00-2.45	-	-	-	-													
		Very Stiff, Layered	44.735		SPT-2	SS	3.00	3.00-3.45	5	7	11	18													
					SPT-3	SS	4.50	4.50-4.95	5	10	18	28													
					SPT-4	SS	6.00	6.00-6.45	9	17	21	38													
Reddish, Hard, Sandy CLAY																									
G.W.L on : Not met with		No. of. SPT		4 nos		No.of.UDS		1 Nos		REMARKS															

Note: SPT-Standard Penetration Test SS-Soil Sample.

UDS-Un Disturbed Sample CS-Core Sample

CR-Core Recovery , RQD-Rock Quality Designation

Project : Conducting Soil Testing & Investigation at 10 MWp Solar PV Power Plant at Neyveli Lignite Corporation Ltd Neyveli, Cuddalore Dist, Tamil Nadu.

 GEO FOUNDATIONS & STRUCTURES PVT. LTD	Location : Neyveli		Drillhole Record - BH 3		
	Bore Hole No : BH-3		Fig No.3		
	Reduced Level : 51.125		Coordinates	X	338549.913
	Type of Boring : Calyx			Y	1283993.662
	Ground Water Level : Not met with		Start Date : 19.08.2014		
Termination Depth : 6.0 m		End Date : 19.08.2014			

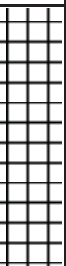
VISUAL SOIL DESCRIPTION	COLOUR	STRUCTURE	REDUCED LEVEL (m)	LEGEND	TEST NO	SAMPLE TYPE	DEPTH FROM G.L (m)	TEST DEPTH(m)	PENETRATION VALUES				SPT 'N' Blows/300mm	SPT 'N' PROFILE					C.R (%)	R.Q.D(%)	REMARKS		
									15cm	30cm	45cm			20	40	60	80	100					
Clayey SAND	Red	Medium Dense, Granular	47.125		SPT-1	SS	1.50	1.50-1.95	4	5	7	12											
					UDS-1	SS	2.00	2.00-2.45	-	-	-	-											
					SPT-2	SS	3.00	3.00-3.45	5	7	9	16											
					UDS-2	SS	4.00	4.00-4.45	-	-	-	-											
Sandy CLAY	Red	Very Stiff, Layered	45.125		SPT-3	SS	4.50	4.50-4.95	7	9	10	19											
					SPT-4	SS	6.00	6.00-6.45	11	13	18	31											
G.W.L on : Not met with			No. of. SPT	4 nos	No.of.UDS	3 Nos	REMARKS																

Note: SPT-Standard Penetration Test SS-Soil Sample.

UDS-Un Disturbed Sample CS-Core Sample

CR-Core Recovery , RQD-Rock Quality Designation

Project : Conducting Soil Testing & Investigation at 10 MWp Solar PV Power Plant at Neyveli Lignite Corporation Ltd Neyveli, Cuddalore Dist, Tamil Nadu.



GEO FOUNDATIONS & STRUCTURES PVT. LTD

Location : Neyveli
 Bore Hole No : BH-4
 Reduced Level : 52.911
 Type of Boring : Calyx
 Ground Water Level : 3.95 m on 14.08.2014
 Termination Depth : 20.0 m

Drillhole Record - BH 4

Fig No.4

Coordinates X : 338679.057
 Y : 1284251.217

Start Date : 12.08.2014
 End Date : 13.08.2014

VISUAL SOIL DESCRIPTION	COLOUR	STRUCTURE	REDUCED LEVEL (m)	LEGEND	TEST NO	SAMPLE TYPE	DEPTH FROM G.L (m)	TEST DEPTH(m)	PENETRATION VALUES			SPT 'N' Blows/300mm	SPT 'N' PROFILE					C.R (%)	R.Q.D(%)	REMARKS		
									15cm	30cm	45cm		20	40	60	80	100					
Sandy CLAY	Red	Hard, Layered	48.411		SPT-1	SS	1.50	1.50-1.95	13	15	16	31										
					SPT-2	SS	3.00	3.00-3.45	15	15	16	31										
					SPT-3	SS	4.50	4.50-4.95	13	15	15	30										
	SPT-4	SS	6.00		6.00-6.45	15	15	14	29													
	SPT-5	SS	7.50		7.50-7.61	>50	-	-	>100													
	SPT-6	SS	9.00		9.00-9.45	20	42	48	90													
G.W.L on : 14.08.14	3.95 m	No. of. SPT	13 nos	No.of.UDS	NIL	REMARKS																





Note: SPT-Standard Penetration Test SS-Soil Sample.

UDS-Un Disturbed Sample CS-Core Sample

CR-Core Recovery , RQD-Rock Quality Designation

Project : Conducting Soil Testing & Investigation at 10 MWp Solar PV Power Plant at Neyveli Lignite Corporation Ltd Neyveli, Cuddalore Dist, Tamil Nadu.

 GEO FOUNDATIONS & STRUCTURES PVT. LTD	Location : Neyveli		Drillhole Record - BH 4		
	Bore Hole No : BH-4		Fig No.4		
	Reduced Level : 52.911		Coordinates	X	338679.057
	Type of Boring : Calyx			Y	1284251.217
	Ground Water Level : 3.95 m on 14.08.2014		Start Date : 12.08.2014		
Termination Depth : 20.0 m		End Date : 13.08.2014			

VISUAL SOIL DESCRIPTION	COLOUR	STRUCTURE	REDUCED LEVEL (m)	LEGEND	TEST NO	SAMPLE TYPE	DEPTH FROM G.L (m)	TEST DEPTH(m)	PENETRATION VALUES			SPT 'N' Blows/300mm	SPT 'N' PROFILE					C.R (%)	R.Q.D(%)	REMARKS
									15cm	30cm	45cm		20	40	60	80	100			
Sandy CLAY	Red	Hard, Layered	39.411		SPT-7	SS	10.50	10.50-10.75	34	>50	-	>100								50/10 cm Penetration
					SPT-8	SS	12.00	12.00-12.26	45	>50	-	>100								
Clayey SAND	Red	Very Dense, Granular	37.911		SPT-9	SS	13.50	13.50-13.77	28	>50	-	>100								50/12 cm Penetration
Clayey SAND with Gravel	Red	Very Dense, Granular	36.411		SPT-10	SS	15.00	15.00-15.11	>50	-	-	>100								50/11 cm Penetration
Silty SAND	Red	Very Dense, Granular	32.911		SPT-11	SS	16.50	16.50-16.77	38	>50	-	>100								50/12 cm Penetration
					SPT-12	SS	18.50	18.50-18.78	42	>50	-	>100								50/13 cm Penetration
Reddish, Very Dense, Clayey SAND with Gravel					SPT-13	SS	20.00	20.00-20.27	45	>50	-	>100								50/12 cm Penetration
G.W.L on : 14.08.14		3.95 m	No. of. SPT	13 nos		No.of.UDS	NIL					REMARKS								

Note: SPT-Standard Penetration Test SS-Soil Sample.

UDS-Un Disturbed Sample CS-Core Sample

CR-Core Recovery , RQD-Rock Quality Designation

Project : Conducting Soil Testing & Investigation at 10 MWp Solar PV Power Plant at Neyveli Lignite Corporation Ltd Neyveli, Cuddalore Dist, Tamil Nadu.

 GEO FOUNDATIONS & STRUCTURES PVT. LTD	Location : Neyveli		Drillhole Record - BH 5		
	Bore Hole No : BH-5		Fig No.5		
	Reduced Level : 52.528		Coordinates	X	338768.215
	Type of Boring : Calyx			Y	1284277.777
	Ground Water Level : 2.45m on 15.08.2014		Start Date : 14.08.2014		
Termination Depth : 6.0 m		End Date : 14.08.2014			

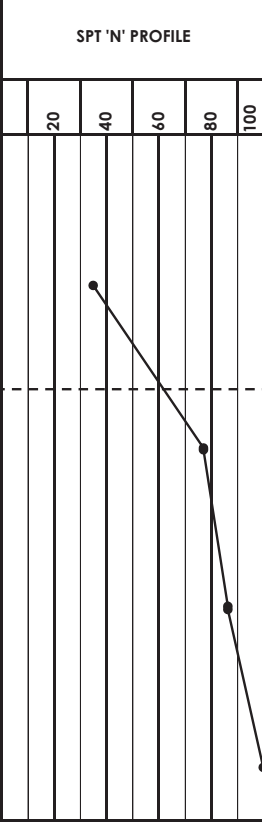
VISUAL SOIL DESCRIPTION	COLOUR	STRUCTURE	REDUCED LEVEL (m)	LEGEND	TEST NO	SAMPLE TYPE	DEPTH FROM G.L (m)	TEST DEPTH(m)	PENETRATION VALUES			SPT 'N' Blows/300mm	SPT 'N' PROFILE					C.R (%)	R.Q.D(%)	REMARKS
									15cm	30cm	45cm		20	40	60	80	100			
Sandy CLAY	Red	Hard, Layered	46.528		SPT-1	SS	1.50	1.50-1.95	15	18	17	35								
					SPT-2	SS	3.00	3.00-3.45	15	31	48	79								
					SPT-3	SS	4.50	4.50-4.95	24	38	48	86								
					SPT-4	SS	6.00	6.00-6.43	24	48	>50	>100								
G.W.L on : 15.08.14		2.45 m	No. of. SPT	4 nos	No.of.UDS	NIL	REMARKS													

Note: SPT-Standard Penetration Test SS-Soil Sample.

UDS-Un Disturbed Sample CS-Core Sample

CR-Core Recovery , RQD-Rock Quality Designation

Project : Conducting Soil Testing & Investigation at 10 MWp Solar PV Power Plant at Neyveli Lignite Corporation Ltd Neyveli, Cuddalore Dist, Tamil Nadu.



**GEO FOUNDATIONS & STRUCTURES
PVT. LTD**

Location : Neyveli
 Bore Hole No : BH-6
 Reduced Level : 51.271
 Type of Boring : Calyx
 Ground Water Level : 2.65m on 15.08.2014
 Termination Depth : 6.0 m

Drillhole Record - BH 6

Fig No.6

Coordinates X : 338680.505
 Y : 1284075.660

Start Date : 14.08.2014
 End Date : 14.08.2014



VISUAL SOIL DESCRIPTION	COLOUR	STRUCTURE	REDUCED LEVEL (m)	LEGEND	TEST NO	SAMPLE TYPE	DEPTH FROM G.L (m)	TEST DEPTH(m)	PENETRATION VALUES				SPT 'N' Blows/300mm	SPT 'N' PROFILE					C.R (%)	R.Q.D(%)	REMARKS	
									15cm	30cm	45cm			20	40	60	80	100				
Sandy CLAY	Red	Loose, Layered	46.771		SPT-1	SS	1.50	1.50-1.95	3	4	6	10										
					UDS-1	SS	2.00	2.00-2.45	-	-	-	-										
					SPT-2	SS	3.00	3.00-3.45	3	4	6	10										
					UDS-2	SS	4.00	4.00-4.45	-	-	-	-										
Clayey SAND	Red	Dense, Granular	45.771		SPT-3	SS	4.50	4.50-4.95	9	17	21	38										
UDS-3	SS	5.50	5.50-5.95	-	-	-	-															
Sandy CLAY	Red	Stiff, Layered	45.271		SPT-4	SS	6.00	6.00-6.45	6	7	8	15										
G.W.L on : 15.08.14		2.65 m	No. of. SPT	4 nos		No.of.UDS	3 Nos		REMARKS													

Note: SPT-Standard Penetration Test SS-Soil Sample.

UDS-Un Disturbed Sample CS-Core Sample

CR-Core Recovery , RQD-Rock Quality Designation

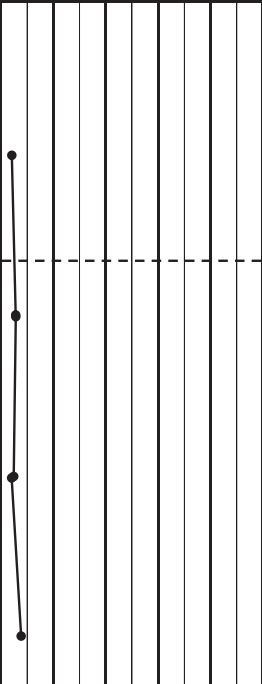
 <p>GEO FOUNDATIONS & STRUCTURES PVT. LTD</p>			Location : Neyveli		Drillhole Record - BH 7	
			Bore Hole No : BH-7		Fig No.7	
Reduced Level : 50.354		Coordinates X : 338721.131		Y : 1283992.220		
Type of Boring : Calyx		Start Date : 16.08.2014		End Date : 16.08.2014		
Ground Water Level : 2.30 m on 17.08.2014						
Termination Depth : 6.0 m						



VISUAL SOIL DESCRIPTION	COLOUR	STRUCTURE	REDUCED LEVEL (m)	LEGEND	TEST NO	SAMPLE TYPE	DEPTH FROM G.L (m)	TEST DEPTH(m)	PENETRATION VALUES			SPT 'N' Blows/300mm	SPT 'N' PROFILE					C.R (%)	R.Q.D(%)	REMARKS									
									15cm	30cm	45cm		20	40	60	80	100												
Clayey SAND	Red	Very Loose, Granular	47.357		SPT-1	SS	1.50	1.50-1.95	1	2	2	4																	
					UDS-1	SS	2.50	2.50-2.95	-	-	-	-																	
		SPT-2			SS	3.00	3.00-3.45	3	3	3	6																		
		UDS-2			SS	4.00	4.00-4.45	-	-	-	-																		
	SPT-3	SS	4.50		4.50-4.95	2	3	2	5	 G.W.L																			
	SPT-4	SS	6.00		6.00-6.45	3	4	4	8																				
	G.W.L on : 17.08.2014		2.30 m		No. of. SPT	4 nos	No.of.UDS	2 Nos	REMARKS																				

Note: SPT-Standard Penetration Test SS-Soil Sample.

UDS-Un Disturbed Sample CS-Core Sample

CR-Core Recovery , RQD-Rock Quality Designation

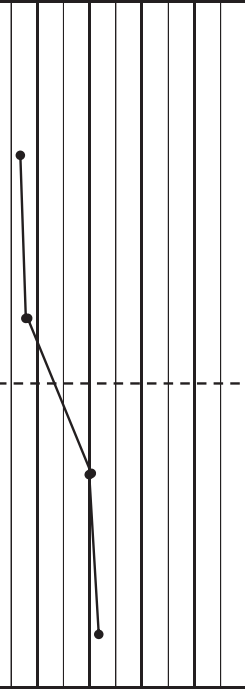
 <p>GEO FOUNDATIONS & STRUCTURES PVT. LTD</p>			Location : Neyveli		Drillhole Record - BH 8	
			Bore Hole No : BH-8		Fig No.8	
Reduced Level : 49.575		Coordinates X : 338719.664		Y : 1283853.330		
Type of Boring : Calyx		Start Date : 16.08.2014		End Date : 16.08.2014		
Ground Water Level : 3.65m on 17.08.2014						
Termination Depth : 6.0 m						

VISUAL SOIL DESCRIPTION	COLOUR	STRUCTURE	REDUCED LEVEL (m)	LEGEND	TEST NO	SAMPLE TYPE	DEPTH FROM G.L (m)	TEST DEPTH(m)	PENETRATION VALUES				SPT 'N' Blows/300mm	SPT 'N' PROFILE					C.R (%)	R.Q.D(%)	REMARKS
									15cm	30cm	45cm	Blows/300mm		20	40	60	80	100			
Sandy CLAY	Red	Stiff, Layered	46.575		SPT-1	SS	1.50	1.50-1.95	4	7	8	15									
					UDS-1	SS	2.00	2.00-2.45	-	-	-	-									
	SPT-2	SS	3.00	3.00-3.45	7	8	10	18													
	UDS-2	SS	4.00	4.00-4.45	-	-	-	-													
Clayey SAND with Gravel	Red	Dense, Garnular	43.575		SPT-3	SS	4.50	4.50-4.95	11	18	22	40									
					SPT-4	SS	6.00	6.00-6.43	13	19	24	43									
G.W.L on : 17.08.14		3.65 m		No. of. SPT		4 nos		No.of.UDS		2 Nos		REMARKS									

Note: SPT-Standard Penetration Test SS-Soil Sample.

UDS-Un Disturbed Sample CS-Core Sample

CR-Core Recovery , RQD-Rock Quality Designation

Project : Conducting Soil Testing & Investigation at 10 MWp Solar PV Power Plant at Neyveli Lignite Corporation Ltd Neyveli, Cuddalore Dist, Tamil Nadu.

 GEO FOUNDATIONS & STRUCTURES PVT. LTD	Location : Neyveli	Drillhole Record - BH 10	
	Bore Hole No : BH-10	Fig No.10	
	Reduced Level : 50.231	Coordinates X : 338874.359	Coordinates Y : 1284045.542
	Type of Boring : Calyx	Start Date : 16.08.2014	End Date : 16.08.2014
Ground Water Level : 2.8 m on 17.08.2014			
Termination Depth : 6.0 m			

VISUAL SOIL DESCRIPTION	COLOUR	STRUCTURE	REDUCED LEVEL (m)	LEGEND	TEST NO	SAMPLE TYPE	DEPTH FROM G.L (m)	TEST DEPTH(m)	PENETRATION VALUES				SPT 'N' Blows/300mm	SPT 'N' PROFILE					C.R (%)	R.Q.D(%)	REMARKS				
									15cm	30cm	45cm	20		40	60	80	100								
Sandy CLAY	Red	Stiff, Layered	45.731	[Grid]	SPT-1	SS	1.50	1.50-1.95	3	4	6	10	[SPT Profile Graph]												
					UDS-1	SS	2.00	-	-	-	-														
		SPT-2			SS	3.00	3.00-3.45	4	7	7	14														
		UDS-2			SS	4.00	-	-	-	-															
Very Stiff, Layered	44.231	SPT-3	SS	4.50	4.50-4.95	7	8	9	17	[SPT Profile Graph]															
		UDS-3	SS	5.50	-	-	-	-																	
Reddish, Stiff, Sandy CLAY					SPT-4	SS	6.00	6.00-6.43	5	7	6	13													
G.W.L on : 17.08.14	2.80 m	No. of. SPT	4 nos	No.of.UDS	3 Nos	REMARKS																			



Note: SPT-Standard Penetration Test SS-Soil Sample,

UDS-Un Disturbed Sample CS-Core Sample

CR-Core Recovery , RQD-Rock Quality Designation

Project : Conducting Soil Testing & Investigation at 10 MWp Solar PV Power Plant at Neyveli Lignite Corporation Ltd Neyveli, Cuddalore Dist, Tamil Nadu.

 GEO FOUNDATIONS & STRUCTURES PVT. LTD	Location	: Neyveli	Drillhole Record - BH 11	
	Bore Hole No	: BH-11	Fig No.11	
	Reduced Level	: 49.713	Coordinates	X 339020.879
	Type of Boring	: Calyx	Y	1283887.761
Ground Water Level	: 1.85 m on 20.08.2014	Start Date	: 19.08.2014	
Termination Depth	: 6.0 m	End Date	: 19.08.2014	

VISUAL SOIL DESCRIPTION	COLOUR	STRUCTURE	REDUCED LEVEL (m)	LEGEND	TEST NO	SAMPLE TYPE	DEPTH FROM G.L (m)	TEST DEPTH(m)	PENETRATION VALUES			SPT 'N' Blows/300mm	SPT 'N' PROFILE					C.R (%)	R.Q.D(%)	REMARKS	
									15cm	30cm	45cm		20	40	60	80	100				
Clayey SAND	Red	Loose, Granular	46.713		SPT-1	SS	1.00	1.00-1.45	3	4	6	10									
					UDS-1	SS	2.00	-	-	-	-										
Sandy CLAY	Red	Hard, Layered	44.213		SPT-2	SS	3.00	3.00-3.45	18	20	24	44									
					SPT-3	SS	4.50	4.50-4.93	32	48	>50	>100									
Clayey SAND	Red	Very Dense, Granular	43.713		SPT-4	SS	6.00	6.00-6.42	38	48	>50	>100	50/13 cm Penetration								
Reddish, Very Dense, Clayey SAND with Gravel																				50/12 cm Penetration	
G.W.L on : 20.08.14		1.85 m	No. of. SPT	4 nos	No.of.UDS	1 No	REMARKS														

Note: SPT-Standard Penetration Test SS-Soil Sample.

UDS-Un Disturbed Sample CS-Core Sample

CR-Core Recovery , RQD-Rock Quality Designation

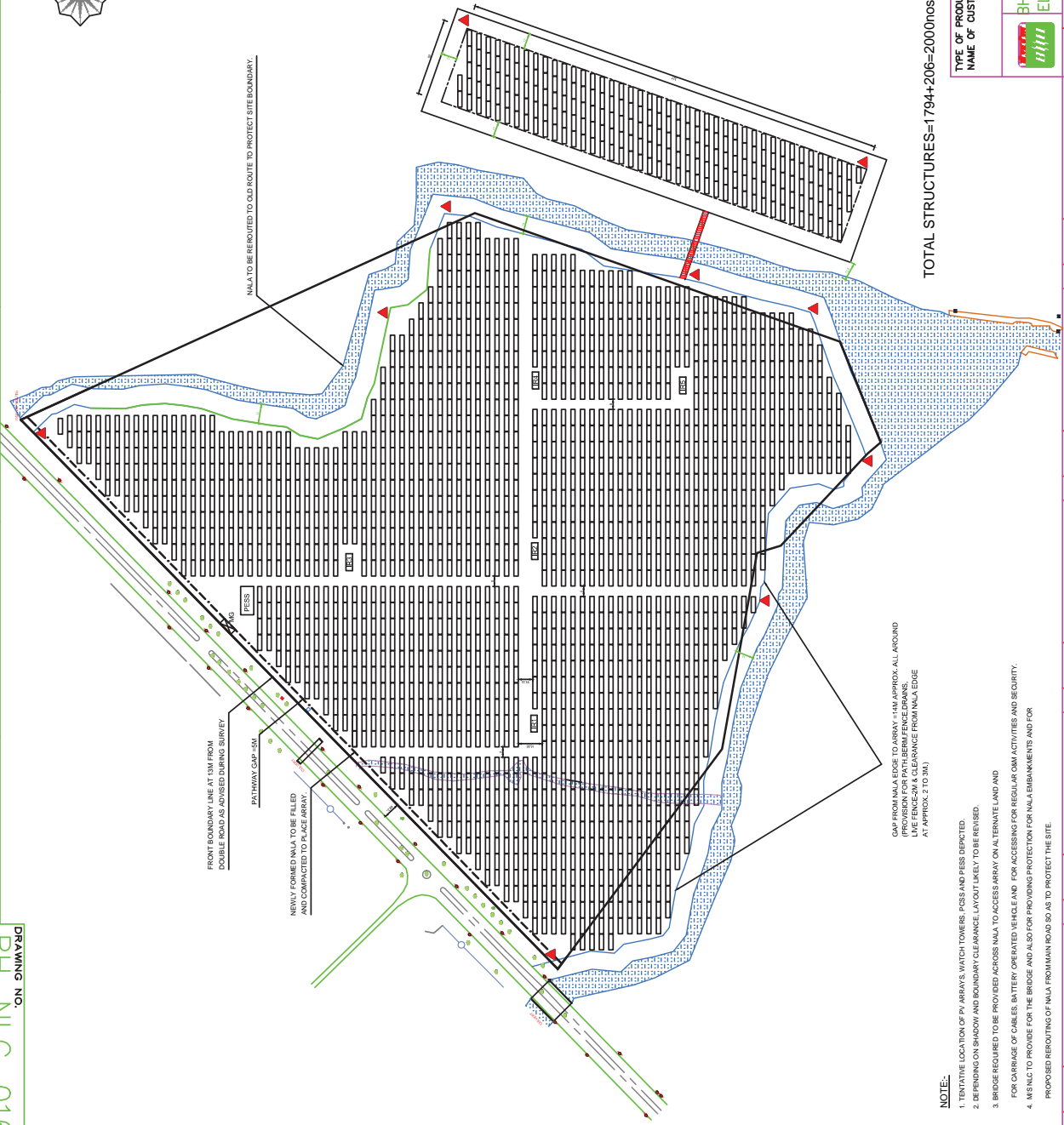

TOTAL STRUCTURES=1794+206=2000nos

MALA TO BE REROUTED TO OLD ROUTE TO PROTECT SITE BOUNDARY.

FRONT BOUNDARY LINE AT 15M FROM DOUBLE ROAD AS ADVISED DURING SURVEY

NEWLY FORMED MALA TO BE FILLED AND COMPACTED TO PLACE ARRAY.

PATHWAY GAP-5M

GAP FROM MALA EDGE TO ARRAY SHALL APPROX. ALL AROUND PROVISION FOR PATH, BERM, FENCE DRAINS, LIFE FENCE AND CLEARANCE FROM MALA EDGE AT APPROX. 2 TO 3M.

NOTE:

1. TENTATIVE LOCATION OF PV ARRAY'S WATCH TOWERS, PCSS AND PESS DEPICTED.
2. DEPENDING ON SHADOW AND BOUNDARY CLEARANCE LAYOUT LIKELY TO BE REVISED.
3. BRIDGE REQUIRED TO BE PROVIDED ACROSS MALA TO ACCESS ARRAY ON ALTERNATE LAND AND FOR CARRIAGE OF CABLES, BATTERY OPERATED VEHICLE AND FOR ACCESSING FOR REGULAR O&M ACTIVITIES AND SECURITY.
4. MSLAC TO PROVIDE FOR THE BRIDGE AND ALSO FOR PROVIDING PROTECTION FOR MALA EMBANKMENTS AND FOR PROPOSED REROUTING OF MALA FROM MAIN ROAD SO AS TO PROTECT THE SITE.

ARRAY DETAILS

PV ARRAY CAPACITY	11.5MWp
Total no. of PV Modules (240Wp)	48000 nos
PV Modules in series string	24 nos
Total No. of strings	2000 nos
Series strings/NV-500kW /1000kW	100/200 nos
No. of Inverters (500kW/1000kW)	20/10 nos
String Monitoring Units (SMU)	140 nos

LEGEND

	2x12-240W STRUCTURE-2000 nos
	COMBINER BOX WITH STRING MONITORING SYSTEM (LOCATIONS SHALL BE INDICATED LATER)
	PCSS(IR1 TO IR5)
	PESS

Inter row gap 4m at 26 deg. inclination



WATCH TOWER



MAIN GATE

TYPE OF PRODUCT OR NAME OF CUSTOMER/PROJECT		10 MW SPV POWER PLANT FOR NEVELLIGONTE CORPORATION LTD	
	NAME	DRN	DATE
	V.S.K	JUL'14	JUL'14
	CDP	SR	JUL'14
	APPD	MS	JUL'14
DEPT. CODE	SCVP	SCALE	WEIGHT(Kg)
430	430	1 : 1	1 : 1
FOR UNSPECIFIED-TOLERANCES REFER ED 0230-499		REV.	DATE
TITLE		11.5 MW ARRAY LAYOUT	NO. OF SHEETS
DRAWING NO.		BH-NLC-016	01

COMMERCIAL TERMS & CONDITIONS				
RFQ No.HBSBOS014 DATED : 15.09.2014 DUE DATE(TECH BID) : 08.10.2014				
Sl No.	Terms	BHEL Term	Confirmation	Deviation / Remarks
1	Bidding	(a) Bid has to be submitted as Two Part – in two sealed covers- Techno Commercial Bid(Part-1) & Price Bid (Part-II)- clearly written on each cover both put in a single sealed envelope super-scribed with RFQ No. and Due date.	Agree / Not agree	
		(b) Annexures B & B1 to be submitted along with technical bid (Part-1) & Annexure B2 to be submitted along with Price bid (Part-II).	Agree / Not agree	
		(c) Clause-wise compliance to BHEL Purchase specification along with all documents as called in Technical specification to be submitted along with technical bid(Part-1).	Agree / Not agree	
2	Price Basis	Firm i.e., from the date of PO to completion of supply if I&C is not applicable. If I&C is in supplier's scope, then the prices shall remain Firm till commissioning & handing-over of the complete system. (PVC clause not acceptable).	Agree / Not agree	
3	Terms of Delivery	Free On Road Basis to Neyveli Site	Agree / Not agree	
4	Delivery Period	(a) Supply : 10 weeks from Sample Approval for specific project OR 12 weeks in case if Vendor bags multiple projects. Drawing Submission: 1 week from PO Date; Sample Submission for Inspection: 3 Weeks from Drawing Approval.	Agree / Not agree	
		(b) I&C-(Involves only Erection and Civil Works): 4 weeks from Supply Date.	Agree / Not agree	
5	Payment Term	(a) Supply : 80% payment of Supply Value + 100% Taxes shall be made with 45 days credit from the date of receipt of material at site. 10% on completion of I&C and certification. Balance 10% on execution of PBG valid for warranty period + 6 months claim period from any of the BHEL Consortium banks.	Agree / Not agree	
		(b) I&C : 90% of basic I&C value + 100% Taxes & Duties on completion of I&C and certification line item wise on pro-rata basis. Balance 10% on execution of PBG valid for warranty period+ 6 months claim period from any of the BHEL Consortium banks.	Agree / Not agree	
		(c) Civil Works : 90% on completion of works and certification line item wise on pro-rata basis. Balance 10% on execution of PBG valid for warranty period + 6 months claim period from any of the BHEL Consortium banks	Agree / Not agree	
		(d) For any deviation in payment term, the offer will be liable for loading as per Clause 25A(ii) of Enquiry-General Terms & conditions (Doc Ref : SCPV/BOS/01-Rev 00)	Agree / Not agree	
6	Excise Duty	(a) To confirm whether applicable. If applicable, indicate prevailing rate of Excise duty.	Applicable / Not applicable	Prevailing rate of Excise duty : %
		(b) BHEL is trying to avail Customs Duty & Excise duty exemption. Successful bidder shall support with all relevant documents.	Agree / Not agree	
7	Sales Tax	(a) To confirm whether applicable. If applicable, indicate prevailing rate of Sales Tax against Form C.	Applicable / Not applicable	Prevailing rate of Sales Tax : %
		(b) For issue of form "C", vendor has to furnish "E1/E2" form. Please confirm that "E1/E2 Sale form" will be submitted.	Agree / Not agree	
8	Value Added Tax	Since it is inter-state movement of goods, VAT is not applicable. Only CST against form C is applicable	Applicable / Not applicable	
		OR Both are in the same State, VAT is applicable please indicate VAT applicable.	Applicable / Not applicable	Prevailing rate of VAT : %
9	Octroi	To confirm whether applicable, if applicable indicate current rate of Octroi.	Applicable / Not applicable	Octroi _____ %
10	Works Contract Tax	Vendor shall ensure quoting WCT inclusive. TDS applicable as per provisions of respective Project-wise state VAT Act. Vendor to be registered under respective Project-wise state VAT, file returns & remit applicable VAT/WCT. Declaration in Form as per State VAT to be submitted by vendor. TDS is applicable as per provisions of respective Project-wise VAT Act. The WCT% included in the offer shall be indicated for availing credit wherever applicable.	Applicable / Not applicable	WCT @ _____ %

AUTHORISED SIGNATORY WITH SEAL

Annexure B

COMMERCIAL TERMS & CONDITIONS				
RFQ No.HBSBOS014 DATED : 15.09.2014 DUE DATE(TECH BID) : 08.10.2014				
Sl No.	Terms	BHEL Term	Confirmation	Deviation / Remarks
10	Service Tax	To confirm whether applicable, if applicable indicate current rate of Service Tax.	Applicable / Not applicable	Prevailing rate of Service Tax %
		Furnish following : Service Tax Regn. No. Confirmation that Service Tax register is maintained.	Applicable / Not applicable	Service Tax Regn. No.....
11	Freight	Freight shall be included (since it is on FOR basis to site) in unit rate quoted.	Agree / Not agree	
12	Insurance	Transit Insurance will be in vendor's scope.	Agree / Not agree	
13	Evaluation of L1 vendor	Over all L1 of Supply + I&C + Civil Works on "FOR" basis to site will only be considered.	Agree / Not agree	
		The percentage of Supply, Civil works and I&C values shall be in the range indicated below (approximately, with overall tallying to 100%) : (a) Supply : 71-73% (b) I&C : 7-9% (c) Civil : 18-20%	Agree / Not agree	
14	Warranty	(a) Warranty for Supply : 18 months from date of supply or 12 months from I&C whichever is earlier. (b) Workmanship / I&C : 12 months from I&C	Agree / Not agree	
15	Pre Shipment Inspection	Pre Shipment Inspection will be carried out by BHEL/Customer for which test report shall be sent one week in advance.	Agree / Not agree	
16	Penalty	(a) Penalty of 0.5% per week at the basic price of the good for undelivered quantity of supply portion, subject to a maximum of 10%. For Supply, Pre Shipment Inspection Call Letter Date (Receipt of test report) will be treated as delivery for purpose of penalty.	Agree / Not agree	
		(b) For any deviation in penalty term, the offer will be liable for loading as per Clause 25.B of Enquiry-General Terms & conditions (Doc Ref : SCPV/BOS/01-Rev 00)	Agree / Not agree	
17	Road Permit	Road permit if applicable will be given by BHEL before Dispatch of ordered Items	BHEL	
18	Despatch Documents	Complete set of despatch documents in 3 sets shall be forwarded to BHEL directly. Despatch documents include Commercial Invoice, Excise Invoice (if ED is applicable), Lorry receipt (L/R), Packing list, Warranty certificate, Insurance intimation letter, & Original Performance Bank Guarantee (Directly from issuing bank to BHEL). One set of Invoice, Packing list and L/R shall be faxed immediately after despatch to BHEL-EDN, Bangalore.	Agree / Not agree	
19	Other terms & conditions	For any other Terms and Conditions, kindly refer to the enclosed Enquiry-General Terms & Conditions of BHEL (Doc Ref : SCPV/BOS/01-Rev 00)	Agree / Not agree	
20	Reverse Auction	BHEL reserves the right to conduct Reverse Auction. Procedure for the same will be informed by BHEL.	Agree / Not agree	
21	Annexure	Technical Specification- PS-439-914 & Annexure-1	Read & Noted	
22	Shipment	Kindly indicate the state from where the shipment will take place	State/Place	
23	Tax Structure for Civil Works	Please indicate the tax structure considered for Civil Works		
24	No. of Projects	Quoted for other Projects also	1. Daman : Yes/No 2. Diu : Yes/No 3. DNH Yes/No 4. KPCL: Yes/No 5. RC Puram : Yes/No 6. OPCL: Yes/No	

TECHNICAL BID ENCLOSURE FOR COMPLIANCE OF QUOTE										
RFQ No.HBSBOS014 DATED : 15.09.2014 DUE DATE(TECH BID) : 08.10.2014										
Sl No.	DESCRIPTION	QTY	UNIT	QUOTED	TAXES					Remarks
					ED %	CST%	VAT %	WCT%	SERVICE TAX %	
1	*PS0679042539: Supply for MMS as per Tech Spec-PS-439-914	1	ST	YES/NO				NA	NA	Taxes Included
2	PS0679042601: Erection of MMS & PV Module as per Tech Spec-PS-439-914	1	AU	YES/NO	NA	NA	NA	NA		Taxes Included
3	PS0679043330: Civil Foundation Works for MMS as per BHEL Spec PS-439-914	1	AU	YES/NO	NA	NA	NA			Taxes Included
4	**Freight Charge including Service Tax on Freight(12.36% on 25% of Freight Value)	LUMPSUM		YES/NO	NA	NA	NA	NA	NA	Included
5	**Insurance	LUMPSUM		YES/NO	NA	NA	NA	NA	NA	Included

NOTE: 1.YOUR QUOTED PRICES SHALL BE on "FREE ON ROAD" basis to Neyveli Site.

2.PLEASE INDICATE TAXES : ED, VAT/CST, SERVICE TAX, WORKS TAX CLEARLY APPLICABLE AS ON DATE.

3. USE THIS FORMAT FOR COMPLIANCE(REPRODUCING ON YOUR LETTER HEAD IS ACCEPTABLE).

4. *ED shall not be considered as the project is under MNRE approval. Hence all inclusive rate for Supply is to be quoted without ED for Sl No.1. However, the percentage of taxes considered against each item may pls be indicated in the column of Taxes for the purpose of availing Tax Credit.

5.Over all L1 of Supply + I&C + Civil Works on "FOR" basis to site will only be considered.

AUTHORISED SIGNATORY WITH SEAL

PRICE BID ENCLOSURE											
RFQ No.HBSBOS014 DATED : 15.09.2014 DUE DATE(TECH BID) : 08.10.2014											
Sl No.	DESCRIPTION	QTY	UNIT RATE (Rs.)	TOTAL RATE (UNIT RATE*QTY) (Rs.)	TAXES					Remarks	
					ED %	CST%	VAT %	WCT %	SERVICE TAX %		
1	*PS0679042539: Supply for MMS as per Tech Spec-PS-439-914	1 ST								NA	TAXES INCLUDED
	Unit Rate in Words Rs.										
2	PS0679042601: Erection of MMS & PV Module as per Tech Spec-PS-439-914	1 AU			NA	NA	NA	NA			TAXES INCLUDED
	Unit Rate in Words Rs.										
3	PS0679043330: Civil Foundation Works for MMS as per BHEL Spec PS-439-914	1 AU			NA	NA	NA				TAXES INCLUDED
	Unit Rate in Words Rs.										
4	Freight Charge including Service tax on Freight	Lumpsum			INCLUDED					**Freight : Included	
5	Insurance	Lumpsum			INCLUDED					**Insurance : Included	

NOTE: 1.YOUR QUOTED PRICES SHALL BE on "FREE ON ROAD" basis to Neyveli Site.

2.PLEASE INDICATE TAXES : ED, VAT/CST, SERVICE TAX, WORKS TAX CLEARLY APPLICABLE AS ON DATE.

3. USE THIS FORMAT FOR COMPLIANCE(REPRODUCING ON YOUR LETTER HEAD IS ACCEPTABLE).

4. *ED shall not be considered as the project is under MNRE approval. Hence all inclusive rate for Supply is to be quoted without ED for Sl No.1. However, the percentage of taxes considered against each item may pls be indicated in the column of Taxes for the purpose of availing Tax Credit.

5.Overall L1 of Supply + I&C + Civil Works on "FOR" basis to site will only be considered.

AUTHORISED SIGNATORY WITH SEAL

Bharat Heavy Electricals Ltd.,
(A Government of India undertaking)
Electronics Division
PB No.2606, Mysore Road, Bangalore-560026, India

Enquiry - General Terms & Conditions (Two part bid)

I. Enquiry / Request for Quotation (RFQ):

- (a) Any Purchase Order resulting from this enquiry shall be governed by **these general terms and conditions listed below and special terms and conditions, if any, along with this enquiry** of Bharat Heavy Electricals Limited, Electronics Division, Bangalore-560026 (**hereinafter referred to as BHEL EDN**).
- (b) Any of the terms and conditions not acceptable to vendor, shall be explicitly mentioned in the quotation. Otherwise, it will be treated as that all terms and conditions of this enquiry are acceptable.
- (c) If counter terms and conditions are offered by vendor, BHEL EDN shall not be governed by such terms and conditions, unless it is agreed and incorporated in the Purchase Order of BHEL EDN.
- (d) Any deviation to the terms and conditions not mentioned in the quotation by vendor in response to this enquiry will not be considered, if put forth subsequently or after issue of order, unless clarification is sought for by BHEL EDN and agreed upon in the Purchase Order of BHEL EDN.
- (e) BHEL EDN reserves the right to adopt Reverse Auction for the enquiry sent, at its discretion.
- (f) BHEL EDN shall be at liberty to cancel the tender at any time, before ordering, without assigning any reason.
- (g) Any specific terms and conditions to be complied will be mentioned in RFQ.**

II. General Terms and conditions:

1. TWO PART BID: Quotation shall be submitted in two part bid i.e.

(a) Techno-commercial i.e., Un-priced Bid (in one sealed envelope):

Techno-commercial bid shall be submitted with complete description of the equipment, specification compliances to the enquired specification and all the commercial terms & conditions indicated in the **COMMERCIAL TERMS (ANNEXURE -A for Foreign Purchase and ANNEXURE-B for Indigenous Purchase)**. Any other enclosure, which the vendor wishes to submit like product catalogue, technical literature etc., may also be submitted in a sealed envelope super scribed clearly as **“TECHNO-COMMERCIAL BID” with RFQ No. and DUE DATE**. An un-priced copy of price bid (without price) as per **ANNEXURE A-1 for Foreign Purchase and ANNEXURE B-1 for Indigenous Purchase** shall also be enclosed with the techno-commercial bid for evaluation of commercial terms.

The vendor shall not give the price in the technical bid.

Confirmation to BHEL specifications shall be indicated by the vendor in the respective columns provided in the purchase specification wherever applicable. Deviations to the specification / item description, if any shall be brought out clearly indicating **“DEVIATION TO BHEL SPECIFICATION”** without fail as a part of technical offer.

Compliance to Pre-qualification criteria (if applicable) shall also be enclosed with the Techno-commercial bid.

Manufacturer's name, their trade mark and brand, part number, alternate material to the one asked in enquiry, if any, should be mentioned in quotation and illustrative leaflets giving technical particulars etc. are to be attached to facilitate consideration and technical evaluation of the quotation. BHEL EDN material code number (as in enquiry) shall be indicated for each item quoted.

(b) Price Bid (in one sealed envelope):

Price bid should contain basic unit prices, discount if any, applicable taxes & duties, packing & forwarding charges (if applicable), Freight & insurances (if applicable), FOB charge (if applicable) etc., in a sealed envelope super scribed clearly as **“PRICE BID” with RFQ No. and DUE DATE**.

It is preferred to indicate the rates in both figures and words. In such case, if there is a difference / discrepancy

Signature of tenderer / with seal

between the rates in figures and words, guidelines as per Annexure H shall be followed. **Price bid shall be quoted as per ANNEXURE A-2 for Foreign Purchase and ANNEXURE B-2 for Indigenous Purchase.**

(c) Tender Offer (above two envelopes inside another sealed envelope):

Both these sealed envelopes [(a) Techno-commercial i.e., un-priced Bid and (b) Price Bid] shall be kept in a single sealed envelope and super scribed clearly with **RFQ No. and DUE DATE.**

2. The above sealed envelope (Tender) shall reach our office on or before the due date by 13:00 hrs. Quotations are to be dropped in the tender box marked for the OPENING ON respective days i.e., **MONDAY (BOX No.4)/ WEDNESDAY (BOX No.6)/ FRIDAY (BOX No.8)** kept at BHEL-EDN's Reception area of our works with caption "**CE, SC & PV, DEFENCE**". **Quotations also can be dispatched by Couriers / Registered post / FAX / e-mail to the Purchase Executive indicated in the RFQ at the risk of vendor / bidder.**

Quotation through courier / register post / fax / email when addressed to the specific fax number and email address given in the enquiry, to be sent well in advance to enable BHEL EDN purchase personnel to drop in the tender box before the scheduled opening date and time. Vendor is fully responsible for lack of secrecy on information of such quotations. Vendor shall confirm with the concerned purchase executive after sending the offer regarding such delivery mode to ensure participation. BHEL EDN is not responsible for any delay in receipt of quotation sent by vendor through post/fax/email.

Late Tenders i.e., Tenders received after due date & time will be rejected.

3. The rate quoted shall be in units stated in the enquiry. Where quotation is in terms of unit other than that in enquiry, relationship between the two units must be furnished in the quotation.
4. As far as possible, the quotations shall be free from corrections / overwriting. Corrections / overwriting, if any should be signed by authorized person with the company seal. Any typographical errors, totaling mistakes, currency mistakes, multiplication mistakes, summary mistakes observed in your priced bids, BHEL may consider whichever is beneficial to BHEL for evaluation. Vendor shall doubly ensure that the quote is correct and complete. The corrections / overwriting if any shall be signed with the seal.
5. Quotations are to be duly signed. Unsigned bids/offers are liable for rejection.
6. Tenders will be opened at **13:30 hrs** & the venue is New Engineering Building, 2nd floor, MM conference hall, BHEL EDN, Bangalore. All the tenderers or their authorized representatives (with authorization letter from their principals) may witness opening of techno-commercial bid on the due date.
7. After evaluation of techno-commercial bids, price bids of only those which are technically & commercially accepted, will be opened on a subsequent date, which will be intimated to the concerned in advance for witnessing of price bid opening.
8. The quantity in each item to be purchased may vary from quantity enquired according to the actual requirement at the time of placing the purchase order.

9. DUN & BRADSTREET REPORT (for Foreign purchase):

In case of foreign vendors, BHEL reserves the right to verify the Dun & Bradstreet report during techno-commercial scrutiny. Please mention DUN Number in **Techno-Commercial bid.**

10. Payment of Agency Commission to Indian Agent (for Foreign purchase):

- a. BHEL shall deal directly with foreign vendors, wherever required, for procurement of goods. However, if the foreign principal desires to avail of the services of an Indian agent, then the foreign principal should ensure compliance to regulatory guidelines - which require mandatory submission of an Agency Agreement.
- b. It shall be incumbent on the Indian agent and the foreign principal to adhere to the relevant guidelines of Government of India, issued from time to time.

Signature of tenderer / with seal

- c. The Agency Agreement should specify the precise relationship between the foreign OEM / foreign principal and their Indian agent and their mutual interest in the business. All services to be rendered by agent/ associate, whether of general nature or in relation to the particular contract, must be clearly stated by the foreign supplier/ Indian agent. Any payment, which the agent or associate receives in India or abroad from the OEM, whether as commission or as a general retainer fee should be brought on record in the Agreement and be made explicit in order to ensure compliance to laws of the country.
- d. Any agency commission to be paid by BHEL to the Indian agent shall be in Indian currency only.
- e. Tax deduction at source is applicable to the agency commission paid to the Indian agent as per the prevailing rules.
- f. In the absence of any agency agreement, BHEL shall not deal with any Indian agent (authorized representatives / associate / consultant, or by whatever name called) and shall deal directly with the foreign principal only for all correspondence and business purposes.
- g. The “Guidelines for Indian Agents of Foreign Suppliers” shall apply in all such cases.
- h. The supply and execution of the Purchase Order (including indigenous supplies/ service) shall be in the scope of the OEM/ foreign principal. The OEM/ foreign principal should submit their offer inclusive of all indigenous supplies/ services and evaluation will be based on ‘total cost to BHEL’. In case OEM/ foreign principal recommends placement of order(s) towards indigenous portion of supplies/ services on Indian supplier(s)/ agent on their behalf, the credentials/ capacity/ capability of the Indian supplier(s)/ agent to make the supplies/ services shall be checked by BHEL as per the extant guidelines of Supplier Evaluation, Approval & Review Procedure (SEARP), before opening of price bids. It will be the responsibility of the OEM/ foreign principal to get acquainted with the evaluation requirements of Indian supplier/ agent as per SEARP available on www.bhel.com.

The responsibility for successful execution of the contract (including indigenous supplies/ services) lies with the OEM/ foreign principal. All bank guarantees to this effect shall be in the scope of the OEM/ foreign principal.

11. Installation & Commissioning:

- (a) Scope will be as per Purchase Specification. I&C value should be quoted separately by bidders.
- (b) Wherever, Service Tax is applicable –
- (c)
 1. The Tenderers shall furnish the Service Tax Registration Number in their offer.
 2. If the Tenderer is not having Service Tax Registration Number, he shall submit an undertaking to the effect that,
 - a. in case he is awarded the contract, he shall register with Service Tax Authorities and furnish the Registration Number before commencement of work, OR
 - b. his turnover value is below the threshold limit prescribed by the Service Tax Act and in case he is awarded the contract, whenever his turnover crosses the threshold limit at any time during the execution of the contract, he shall forthwith register with Service Tax Authorities and furnish the Registration Number to BHEL. (This sub-clause is NOT applicable where the taxable turnover of the present tender is above the prescribed threshold limit).
 3. Any offer not complying with the above clauses is liable to be rejected.
 4. The above clauses apply even where the price quoted is “inclusive of taxes”.
 5. If the Service Tax Registration Number is not furnished to BHEL before the first bill is submitted (except as provided in Clause 2(b) above), the bills will not be passed (even if the price is “inclusive of taxes”).
 6. In case of contracts involving multiple bills, every bill (commencing with the 2nd bill) shall be accompanied with a declaration that the contractor has discharged his tax liability on the earlier bill (i) by paying the money to the Government (along with Challan details) or (ii) by utilization of Input Service Tax Credit available with him or (iii) being exempt as his turnover continues to be below the threshold limit. In the absence of such a declaration, the bill shall not be passed.
 7. In case of contracts involving a single bill, the bill shall be accompanied with an undertaking that the contractor shall discharge his tax liability on that bill as per law.

12. **TOTAL COST TO BHEL:** Purchase order will be placed on the lowest quotation (L1) only among the technically & commercially accepted quotations. Lowest quotation (L1) is determined on the basis of the total cost to BHEL. Loading Factors for deviation to BHEL Commercial terms and conditions will be considered.

Signature of tenderer / with seal

For Foreign offers, the Exchange rate (TT selling rate of SBI) shall be taken as under.

Single part bids	Date of Tender opening
Two/Three part bid	Date of Part-1 bid opening
Reverse Auction	Date of Part-1 bid opening

If the relevant day happens to be a bank holiday, then the forex rate as on the previous bank (SBI) working day shall be taken.

- (1) If Freight is quoted extra, original money receipt from Transporter shall be submitted for payment of Freight charges.
- (2) C-form : For issue of form "C", vendor has to furnish "E1/E2" form.

12. FIRM PRICE:

Rates quoted should be firm from the date of offer, till completion of supply. No enhancement in the rates and changes in the techno-commercial terms will be allowed once the quotation is accepted and order is placed.

If Installation & Commissioning is in vendor's scope, then the price shall remain FIRM till commissioning & handing over of the complete system.

13. TERMS OF PAYMENT:

1. SUPPLY FOR FOREIGN PURCHASE: Payment will be made against "SIGHT DRAFT" on presentation of documents to our bankers . Payment through LC is also made subject to loading factors as per Clause 25 (A). For LC payment bank charges within India will be borne by BHEL and outside India will be to vendor's account.

The payment terms are as follows:

SIGHT DRAFT PAYMENT (direct payment):

SUPPLY :

(a) **I&C not included in vendor's scope** : 90% payment of Supply value + 100% Taxes shall be made with 45 days credit from the date of receipt of material at site. Balance 10% on execution of PBG valid for warranty period + 6 months claim period from any of the BHEL Consortium banks.

(b) **Supply & I&C in vendor's scope** : 80% payment of Supply value + 100% Taxes shall be made with 45 days credit from the date of receipt of material at site. 10% on completion of I&C and certification line item wise on pro-rata basis. Balance 10% on execution of PBG valid for warranty period + 6 months claim period from any of the BHEL Consortium banks..

(B) FOR INDIGENOUS PURCHASE (DIRECT PAYMENT):

1. For Supply :

(a) **I&C not included in vendor's scope** : 90% payment of basic Supply value + 100% Taxes and duties shall be made with 45 days credit from the date of receipt of material at site. Balance 10% on execution of PBG valid for warranty period + 6 months claim period from any of the BHEL Consortium banks. PBG value shall be 10% of basic supply PO value.

(b) **Supply and I&C in vendor' scope** : 80% payment of basic Supply value + 100% Taxes and duties shall be made with 45 days credit from the date of receipt of material at site. 10% on completion of I&C and certification line item wise on pro-rata basis. Balance 10% on execution of PBG valid for warranty period + 6 months claim period from any of the BHEL Consortium banks. PBG value shall be 10% of basic supply PO value.

2. For I&C: 100% on completion of I&C and certification line item wise on pro-rata basis.

3. Civil Works : 90% on completion of activity milestone and certification line item wise from site-in charge. Balance 10% against PBG for 10% of basic Civil value valid warranty period + 6 months claim period from any of the BHEL Consortium banks. PBG value shall be 10% of basic civil PO value.

4. O&M : 100% O&M charges are payable as per RFQ terms against report certified by BHEL.

If PBG cannot not be submitted, vendors can also accept for the final 10% payment, payable after the warranty period + 6 months of claim period against supplementary invoice subject to the completion of commissioning (if applicable) as PBG is linked to

Signature of tenderer / with seal

Warranty period.

For any deviation in payment term, the offer will be loaded as per Clause 25.00.

5. ADVANCE PAYMENT: Quotations with “Advance payment/Inland LC” shall be rejected.

14. PENALTY:

Failure to supply within the delivery time as per purchase order will make the vendor liable to an unconditional penalty of 0.5 % (half percent) per week at the basic price of the goods for the undelivered quantity, subject to a maximum of 10%.

Supply : Date of issue of pre -shipment inspection/ call letter with supporting documents like test reports/conformance to test carried by the vendor will be treated as date of dispatch for the purpose of penalty calculation wherever Pre-Inspection is carried out.

For all other activities, the actual date of completion of activity as certified by concerned site-incharge will be considered for the purpose of penalty calculation.

15. PBG:

Performance Bank Guarantee (PBG) to be submitted on non-judicial stamp paper as per the BHEL prescribed format given in **ANNEXURE-E for Foreign Purchase and Annexure-F for Indigenous Purchase** for 10% of the total supply value obtained from any BHEL member (consortium) banks indicated in **ANNEXURE-G**.

The Bank Guarantee shall be submitted directly to the concerned Purchase Executive by the issuing Bank with their forwarding letter. BHEL will verify independently with the bank to establish the authenticity. Alternately, standby LC issued from approved banker can also be considered.

16. TERMS OF DELIVERY:

(a)FOR IMPORTED PURCHASE:

Price offered shall be for goods packed and delivered **FOB** Seaport,/FCA International Airport including packing, forwarding, Handling, Ancillary charges like processing of Sight Draft, negotiation charges of bank, Export declaration, Certificate of origin etc.

Packing shall be Air/Sea worthy, best suitable for trans-shipment and to take care of transit damages. If containerized, no. of containers & size of container shall be mentioned. Packing weight (gross & net) Packing dimensions shall be given prior to shipment to ascertain whether the consignment can be carried on standard cargo in contract or as ODC.

Wooden packing material for all the foreign consignments should be treated as per ISPM-15 & **Fumigation / Phytosanitary certificate** to be submitted to the freight forwarders/ BHEL along with the invoice, B/L, packing list etc.

Vendors shall indicate the name of International Airport/Seaport. Approved Airports are as per **Annexure-C**. The consignment shall be handed over to BHEL approved freight forwarder as mentioned in PO.

(b) FOR INDIGENOUS PURCHASE:

Equipment shall be delivered on “FOR SITE” basis, inclusive of freight, packing, insurance & forwarding charges.

Packing shall be Road / Rail / Air / Sea worthy, best suitable for transshipment and to take care of transit damages.

Smaller consignments can be dispatched through Courier services/ RPP with the prior approval of the purchasing Executive.

17. DELIVERY REQUIREMENT:

Delivery date mentioned in RFQ is tentative. Actual requirement is as per RFQ terms & conditions.

18. VALIDITY:

Quotation should remain valid for a period of **90 days** from the date of technical bid opening.

19. POST-ORDER REQUISITES:

- a. Vendor shall give an Order Acknowledgement indicating the delivery date within one week of receipt of PO.
- b. Pre-shipment inspection at vendor’s works, if required, will be carried out by BHEL/Customer. Required assistance will have to be provided by the vendor at the time of pre-shipment inspection.
- c. Test certificates, Calibration certificates and warranty certificates as stipulated at the time of ordering shall be furnished.

Signature of tenderer / with seal

- d. Items shall be dispatched by Air worthy /Sea worthy/ Road worthy packing. Any damage and later rejection, due to poor / improper packing shall be to vendor's account.
- e. Any damage/rejection should be made good or replaced immediately without any extra cost to BHEL such as freight, duties, taxes etc. The liability is restricted to the value of the order.
- f. Wherever commissioning is involved, it shall be carried out by the vendor's qualified engineers. Scope of work includes installation, commissioning and start-up trials till satisfactory performance level is reached as certified by BHEL.
- g. BHEL will not be responsible for any loss, damage or injuries to vendor's personnel sustained during installation / commissioning / start-up trials. Vendor shall ensure compliance with all statutory requisites as laid down by local bodies, state & Central Government. Vendor shall indemnify BHEL for all damages/ losses to various personnel during their presence in BHEL's premises for whatever purpose.
- h. Suitable markings & damage control indicating devices shall be provided where applicable.
- i. Equipment shall comply with the standard requirements of ISO 14001 & OHSAS 18001.

20. RISK PURCHASE:

The purchaser at his discretion may also make purchase of the materials NOT supplied in time at the RISK & COST of the supplier. In this event, it will be obligatory on the part of the supplier who fails to supply the goods in time to make good to BHEL any loss due to such risk purchase.

21. GENERAL TERMS AND CONDITIONS GOVERNING REVERSE AUCTION (RA):

- (a) BHEL reserves the right to go for Reverse Auction (RA) instead of opening the sealed envelope price bid, submitted by the bidder. This will be decided after techno-commercial evaluation. All bidders to give their acceptance for participation in RA.
Non-acceptance to participate in RA may result in non-consideration of their bids, in case BHEL decides to go for RA.
- (b) In case BHEL decides to go for Reverse Auction, only those bidders who have given their acceptance to participate in RA will be allowed to participate in the Reverse Auction. Those bidders who have given their acceptance to participate in Reverse Auction will have to necessarily submit "online sealed bid" in the Reverse Auction. Non-submission of "online sealed bid" by the bidder will be considered as tampering of the tender process and will invite action by BHEL as per extant guidelines in vogue."
- (c) **Kindly refer to Annexure D for Terms & Conditions of Reverse Auction.**
- (d) Vendor shall confirm acceptance for RA in **ANNEXURE A/B**.

22. REGRET LETTER: In case any vendor is unable to quote, vendor shall send a regret letter.

23. Any dispute arising out of this, shall be referred to the sole arbitration of Head of Dept. Materials Management of group concerned, BHEL EDN or any other officer nominated by him and his award shall be final and binding on the parties. The venue of the arbitration in all cases shall be Bangalore, India.

24. Any legal suit in respect of this enquiry lies in the court of Jurisdiction of Bangalore (India) only.

25. LOADING FACTORS:

Loading factors as detailed below will be added to the quoted price (basic) to evaluate the lowest quote for non compliance of BHEL standard commercial term.

A (i). For non compliance of standard Terms of payment (For Foreign Purchase Orders)

Sl. No.	BHEL standard term	If you quote	Loading factor in % for non-compliance
1	80% against "SIGHT DRAFT" + 20% after commissioning and against PBG(where both commissioning & PBG are applicable)	Payment through Letter of Credit (LC)	10%

In general, if the quote is through L/C, it shall be opened 30 days prior to dispatch and valid for 3 months.

Signature of tenderer / with seal

A(ii).For non compliance of standard Terms of payment (For Indigenous Purchase Orders)

Sl. No.	BHEL standard term	If you quote	Loading factor in % for non-compliance
1	As per RFQ Terms	Any other Payment term	10%

B.For non compliance of standard Terms of Penalty

Sl. No.	BHEL standard term	If you quote	Loading factor for non-compliance
1	Penalty of 0.5% per week subject to max. of 10% on the basic value of the items not supplied /delayed	Other than the above.	Loading Factor 10%-Quoted Max %

26. Non Compliance of Warranty terms : Offers not complying with Warranty terms as per RFQ Terms is liable for rejection.

ANNEXURE- C**LIST OF INTERNATIONAL AIRPORTS**

Sl. No	Country	Air Ports
1	Austria	Vienna, Linz, Graz
2	Australia	Sydney, Melbourne, Perth
3	Belgium	Antwerp, Brussels
4	Canada	Toronto, Montreal
5	China	Shanghai
6	Cyprus	Lamaca
7	Czech Republic	Prague (Via Frankfurt)
8	Denmark	Copenhagen
9	Egypt	Cairo
10	Finland	Helsinki
11	France	Paris (Rossy), Lyon
12	Germany	Darmstadt, Manheim, Nurnberg, Hamburg, Stuttgart, Munich, Koln, Dusseldorf & Hannover, Frankfurt, Berlin
13	Hong Kong	Hong Kong
14	Italy	Rome, Milan, Turin, Bologna, Florence
15	Ireland	Dublin
16	Israel	Telaviv
17	Japan	Tokyo, Osaka
18	Malaysia	Kuala lumpur, Penang
19	Netherlands	Amsterdam, Rotterdam
20	New Zealand	Auckland
21	Norway	Oslo
22	Oman	Muscat
23	Philippines	Manila
24	Romania	Bucharest
25	Russia	Moscow
26	Saudi Arabia	Riyad
27	Singapore	Singapore
28	Slovakia	Bartislowa
29	South Africa	Johannesburg, Durban
30	South Korea	Kimpo
31	Spain	Barcelona
32	Sweden	Stockholm, Gothenburg, Milano
33	Switzerland	Basle, Zurich, Geneva
34	Taiwan	Taipei
35	U.A.E.	Dubai
36	U.K.	Landon (Heathrow), Newcastle, Oxford, Cheltham, Bristol, Welling borough, Birmingham, East Midland, Manchester, Leeds, Glasgow.
37	U.S.A.	New York, Chicago, San Francisco, Los Angeles, Atlanta
38	Ukraine	Kiev

Annexure - D**Terms & Conditions of Reverse Auction**

Against this enquiry for the subject item/ system with detailed scope of supply as per enquiry specifications, BHEL may resort to "REVERSE AUCTION PROCEDURE" i.e., ON LINE BIDDING (THROUGH A SERVICE PROVIDER). The philosophy followed for reverse auction shall be English Reverse (No ties).

- (1) For the proposed reverse auction, technically and commercially acceptable bidders only shall be eligible to participate.
- (2) Those bidders who have given their acceptance for Reverse Auction (quoted against this tender enquiry) will have to necessarily submit 'online sealed bid' in the Reverse Auction. Non-submission of 'online sealed bid' by the bidder for any of the eligible items for which techno-commercially qualified, will be considered as tampering of the tender process and will invite action by BHEL as per extant guidelines in vogue.
- (3) BHEL will engage the services of a service provider who will provide all necessary training and assistance before commencement of on line bidding on internet.
- (4) In case of reverse auction, BHEL will inform the bidders the details of Service Provider to enable them to contact & get trained.
- (5) Business rules like event date, time, bid decrement, extension etc. also will be communicated through service provider for compliance.
- (6) Bidders have to fax the Compliance form (annexure IV) before start of Reverse auction. Without this, the bidder will not be eligible to participate in the event.
- (7) In line with the NIT terms, BHEL will provide the calculation sheet (e.g., EXCEL sheet) which will help to arrive at "Total Cost to BHEL" like Packing & forwarding charges, Taxes and Duties, Freight charges, Insurance, Service Tax for Services and loading factors (for non-compliance to BHEL standard Commercial terms & conditions) for each of the bidder to enable them to fill-in the price and keep it ready for keying in during the Auction.
- (8) Reverse auction will be conducted on scheduled date & time.
- (9) At the end of Reverse Auction event, the lowest bidder value will be known on auction portal.
- (10) The lowest bidder has to fax/e-mail the duly signed and filled-in prescribed format for price breakup including that of line items, if required, (Annexure VII) as provided on case-to-case basis to Service provider within two working days of Auction without fail.
- (11) In case BHEL decides not to go for Reverse Auction procedure for this tender enquiry, the Price bids and price impacts, if any, already submitted and available with BHEL shall be opened as per BHEL"s standard practice.
- (12) Bidders shall be required to read the "Terms and Conditions" section of the auctions site of Service provider, using the Login IDs and passwords given to them by the service provider before reverse auction event. Bidders should acquaint themselves of the „Business Rules of Reverse Auction", which will be communicated before the Reverse Auction.
- (13) If the Bidder or any of his representatives are found to be involved in Price manipulation/ cartel formation of any kind, directly or indirectly by communicating with other bidders, action *as per extant BHEL guidelines*, shall be initiated by BHEL and the results of the RA scrapped/ aborted.
- (14) The Bidder shall not divulge either his Bids or any other exclusive details of BHEL to any other party.
- (15) In case BHEL decides to go for reverse auction, the H1 bidder(s) (whose quote is highest in online sealed bid) may not be allowed to participate in further RA process.

Signature of tenderer / with seal

ANNEXURE-E

PERFORMANCE BANK GUARANTEE
(FOR FOREIGN PURCHASE ORDERS)
BANK NAME AND ADDRESS

Bharat Heavy Electricals Limited (BHEL),
 Electronics Division,
 PB No. 2606,
 Mysore Road,
 BANGALORE- 560 026
 INDIA
 Dear Sirs,

Ref: CONTRACT PERFORMANCE GUARANTEE.

WHEREAS you have entered into a contract reference No PO NO. _____ with M/s _____ having its registered office at _____ for the supply of _____ as detailed in your purchase order No. _____ which is hereinafter referred to as "the said contract" and WHEREAS M/s _____ has undertaken to produce a Bank Guarantee for 10% (Ten Percent) of _____ the contract price amounting to _____ (_____) to secure its obligations to Electronics Division, BHEL having its registered office at New Delhi for the performance of the contract including the warranty of the equipment supplied, We _____ Bank _____ hereby expressly, irrevocably and unreservedly undertake and guarantee as principal obligors on behalf of M/s _____ that in the event Bharat Heavy Electricals Ltd. (B.H.E.L.) declares to us in writing that M/s _____ has not fulfilled any obligation according to the contractual obligation of the said contract, to pay you on demand and without demur to Bharat Heavy Electricals Ltd., Electronics Division , Mysore Road, P.B.No. 2606, Bangalore-560 026, India an amount of _____ (in words _____) subject to as may be determined below:

- 1) Notwithstanding any right M/s. _____ may have directly against you or any disputes raised by M/s _____, Your written demand shall be conclusive evidence to us that repayment is due under the terms of the said contract and shall be binding on us.
- 2) We shall not be discharged or released from this undertaking and Guarantee by any arrangements, variations made between you and M/s. _____ with or without our consent and Knowledge or by any alterations in the obligations of M/s. _____ by any forbearance whether as to payment, time, performance or otherwise.
- 3) This guarantee shall remain valid until the end of twenty-four weeks after the close of the warranty period or until the same is reported by BHEL to us whichever is earlier.
- 4) We agree and undertake not to revoke this guarantee during its validity unless discharged in writing by you subject to the provision of clause (7) below.
- 5) This guarantee shall be a continuing guarantee subject to the foregoing and shall not be discharged by any change in the constitution of the Bank or M/s. _____.
- 6) This guarantee shall be governed by and constructed in accordance with the Laws of India.
- 7) At any time _____ Bank may render this guarantee null and void by paying to Bharat Heavy Electricals Ltd. the full amount being _____ (in words _____)

Note:

- (1) To be executed in Non-Judicial stamp paper by any authorized Indian Bank.
- (2) To be submitted directly by banker to concerned executive in purchase dept., Please give BHEL address to banker.
- (3) Do not enclose with Bank document.
- (4) Any Modification & omissions to this are not permitted

Signature of tenderer / with seal

ANNEXURE - F**PERFORMANCE BANK GUARANTEE
(FOR INDIGENOUS PURCHASE ORDERS)**

THIS DEED OF GUARANTEE made and executed on the _____ day of _____ (year), by the _____ (Bank), registered under the Companies Act 1956/Nationalized Bank constituted under the Banking Companies (acquisition and transfer of undertakings) Act constituted under the State Bank of India Act / Subsidiary Banks Act, having its registered / head office at _____ represented herein by its Branch Manager / authorized representative Sri. _____ & Sri. _____ (Hereinafter called 'guarantor' which term shall mean and include its successors and assigns)

IN FAVOUR OF BHARAT HEAVY ELECTRICALS LIMITED

_____ (Buyer's Name), a company registered under the companies Act, 1956 having its registered office at BHEL House at Siri Fort , New Delhi -100 049 and its Electronics Division at Mysore road, Bangalore-26 (hereinafter referred to as the 'Company' Which term shall include its successors and assigns):

Whereas the company has placed an order on _____ (State the name of the company / firm and its address) (hereinafter referred to as the 'Supplier' which term shall mean and include its liquidators, successors and assign) for the supply of system under order / Contract No. Dt. _____

AND WHEREAS the supplier has agreed to supply the materials and carryout the works as detailed and in accordance with the terms set out in the said order/contract.

AND WHEREAS the company is not required to pay to the supplier a sum of Rupees _____ being the 10% of the value of the goods supplied / Works performed / Services rendered under the said order / contract between the supplier and the company, till the company is satisfied with the mechanical Warranties and the performance standards stipulated in the said order / contract between the company and the supplier has been duly fulfilled, except against a Bank Guarantee for the said sum of Rs _____ in favour of the company by reputed Bank, in which case the company has agreed to make payment to the supplier of the said sum of Rupees _____ being (..%) of the value of the goods supplied / Works performed / Services rendered under the agreement between the supplier and the company and the Guarantor has at the request of the supplier, agreed to furnish this Guarantee subject to the terms and conditions stated below:

NOW THIS DEED WITNESSES THAT IN pursuance of the above said agreement, the guarantor hereby agrees and covenants With company is as follows :-

- 1) That during the period this contract of Guarantee remains effectual, the guarantor shall be liable in respect of the amount due and owing to the company in respect of the payments to the extent of Rs _____ (in words) _____ against any loss or damage caused to or suffered by the company by reasons of any breach of the terms of the said order / contract / Agreement by the supplier.
- 2) The Guarantor hereby undertakes to pay the amounts due and payable under this guarantee without any demur, merely on demand from the company intimating that the amount claimed is due by way of loss or damage caused to or suffered or would be caused or suffered by the supplier of any terms contained in the said order / contract. Any such demand made on the guarantor shall be conclusive as regards the amount due and payable by the Guarantor irrespective of the fact whether the Contractor / supplier admits or denies.
- 3) The Guarantor further agrees that the agreement herein contained shall remain in force and effect till all the supplies to be made / Works to be performed / Services to be rendered under the said order / contract / agreement are completed to the entire satisfaction of the company or till company certifies that the terms and conditions of the said order / contract / agreement have been fully and properly carried out by the said supplier and accordingly discharges the Guarantee. Unless a demand or claim under this guarantee is made on the guarantor in writing on or before the expiry of claim period indicated in clause 6 below, the guarantor shall be discharged from all the liability under this guarantee thereafter.
- 4) The guarantor further agrees with the company that the company shall have the fullest liberty without the consent of the guarantor and without effecting in any manner the obligations of the guarantor hereunder to vary any of the terms of the said order / contract / agreement or extend the time of performance by the said supplier from time to time or refrain from exercising the power exercisable by the company against the said supplier or to forebear or omit to enforce any of the terms and conditions relating to the said order / contract / agreement, and the guarantor shall not be relieved of its liability in whole or in part , by reason of any act, commission or forbearance on the part of the company or by reason of any such variation, or extension being granted to the said

Signature of tenderer / with seal

supplier or by reason of any such matter or thing whatsoever which under the law relating to sureties would but for this provision have effect of so relieving the guarantor.

- 5) The guarantor undertakes not to revoke this guarantee during its currency except with the previous consent of the company in writing.
- 6) Notwithstanding anything herein above contained, the liability of the guarantor under these presents is restricted to Rs _____. The guarantee shall be in force till its expiry on _____ unless a demand is made on the guarantor within SIX months from the date of expiry, all the liability of the guarantor under this guarantee shall stand fully discharged. The decision of the claimant in regard to breach of contract is final and binding on the Bank.

IN WITNESS whereof, the guarantor, acting through it authorized representative has executed this deed of Guarantee on the day, month and year first above written.

(Seal of the Bank to be affixed)

WITNESS

- 1.
- 2.

Note:

- (1) To be executed in INR 100 Non-Judicial stamp paper by any authorized Indian Bank.
- (2) To be submitted directly by banker to concerned executive in purchase dept., Please give BHEL address to banker.
- (3) Do not enclose with Bank document.
- (4) Any Modification & omissions to this are not permitted.

BHEL MEMBER BANKS (CONSORTIUM BANKS)**PBG SHALL BE ISSUED FROM THE FOLLOWING BANKS OR THEIR BRANCH OFFICES ONLY**

1	STATE BANK OF INDIA
2	PUNJAB NATIONAL BANK
3	HDFC BANK
4	SYNDICATE BANK
5	CANARA BANK
6	INDIAN BANK
7	ST. BANK OF HYDERABAD
8	ICICI BANK
9	STANDARD CHARTEREDBANK
10	UCO BANK
11	KOTAK MAHINDRA
12	ORIENTAL BANK OF COMMERCE
13	STATE BANK OF TRAVANCORE
14	CENTRAL BANK
15	IDBI BANK
16	FEDERAL BANK
17	HSBC LTD
18	DEUTSCHE BANK
19	CORPORATION BANK
20	CITI BANK
21	BANK OF BARODA
22	ABN AMRO BANK
23	UNITED BANK OF INDIA
24	VIJAYA BANK
25	UNION BANK OF INDIA
26	PUNJAB & SIND BANK
27	ANDHRA BANK
28	BANK OF INDIA
29	AXIS BANK

The above list is tentative and is subject to change from time to time.
The Purchase Executive shall be contacted for confirmation of the same.

DISCREPANCY IN WORDS & FIGURES – QUOTED IN PRICE BID

Following guidelines will be followed in case of discrepancy in words & figures-quoted in price bid:

- (a) If, in the price structure quoted for the required goods/services/works, there is discrepancy between the unit price and the total price (which is obtained by multiplying the unit price by the quantity), the unit price shall prevail and the total price corrected accordingly, unless in the opinion of the purchaser there is an obvious misplacement of the decimal point in the unit price, in which case the total price as quoted shall govern and the unit price corrected accordingly.
- (b) If there is an error in a total corresponding to the addition or subtraction of subtotals, the subtotals shall prevail and the total shall be corrected; and
- (c) If there is a discrepancy between words and figures, the amount in words shall prevail, unless the amount expressed in words is related to an arithmetic error, in which case the amount in figures shall prevail subject to (a) and (b) above.
- (d) If there is such discrepancy in an offer, the same shall be conveyed to the bidder with target date upto which the bidder has to send his acceptance on the above lines and if the bidder does not agree to the decision of the purchaser, the bid is liable to be ignored.

Signature of tenderer / with seal