



MAHARATNA  
COMPANY

MATERIAL MANAGEMENT (PURCHASE)  
CENTRAL FOUNDRY FORGE PLANT, BHEL HARDWAR  
RANIPUR, HARIDWAR (INDIA) – 249403

Phone No.01334-281277/284684, FAX No. 01334-225892

e-mail :ranjank@bhelhwr.co.in, kraj@bhelhwr.co.in, rranjeet@bhelhwr.co.in

**Sub: Open Tender Enquiry No: 4411P/360/3/0578F1**

Dear Sir,

We are pleased to invite offer as per enclosed specification with terms and conditions in sealed envelop for the under mentioned material.

SI No	Tender No	Description of Material	Quantity	Date & Time of Tender Opening
01	<b>4411P/360/3/0578F1</b>	Different Types of Castings.	570 Nos	16.04.14 at 2.00 PM (IST)

Kindly read terms and conditions carefully. Offer not submitted in accordance with the instructions is liable to be disqualified or ignored.

Please visit [www.bhel.com](http://www.bhel.com) or [www.bhelhwr.co.in](http://www.bhelhwr.co.in) for more details and tender documents.

Please also download Supplier Registration Form and submit same dully filled.

Thanking You,

Yours Faithfully,  
For & On behalf of CFFP BHEL Hardwar

(Raj Kishore)  
Manager (Purchase)

**Note: All corrigenda, addenda, amendments, time extensions, clarifications, etc. to the tender if any shall not be published, kindly visit web-site for any changes.**

CFFP



निविदा सूचना  
**TENDER ENQUIRY**

AA-17001

भारत हैवी इलैक्ट्रिकल्स लिमिटेड  
**Bharat Heavy Electricals Ltd**

सेन्द्रल फाउन्ड्री फॉर्ज प्लांट- हरिद्वार - २४६४०३ (भारत)

**Central Foundry Forge Plant, Haridwar-249403 (INDIA)**

Phone : (0091) 01334- 281639,281385,285336

Fax : 01334 225892 / 226458

TIN NO. 05001763485

CST NO. HR-5018287 Dt. 16-03-14

निविदा सूचना सं. ENQUIRY NO.★

**4411 P/ 360/3/0578F1**

दिनांक Date

**20-03-2014**

कृपया निम्नलिखित के लिए निविदा दें। PLEASE QUOTE FOR THE FOLLOWING :

M/S. ::

DUEDATE

**16-04-20**

INDIA

Vendor Code

**09285**

SL	MATERIAL CODE ITEM DESCRIPTION	QUANTITY	UNIT	LOTNO	LOT DELIVERY QTY SCHEDULE
1	FP8121011566 DRG: DRG.NO.01,01,018 R2 REV: CORNER CURB CASTING TYPE-1 DRG.NO.01 01 018 R2 MATL.H.R.STEEL	20	NO	1	20 30/07/14
2	FF8121011574 DRG: DR.NO.01,01,019 R3. REV: SIDE CURB CASTING TYPE-3 DRG NO.01 01 019R3 MATL.H.R.STEEL	250	NO	1	250 30/07/14
3	FF8121011370 DRG: DRG.NO.01,01,156 R3. REV: FRONT DOOR SEAL CASTING DRG.NO.01 01 156 R3 ITEM -1 MATL.HEAT RESISTANT STEEL	50	NO	1	50 30/07/14
4	FF8121011388 DRG: DRG.NO.01,01,156 R3. REV: FRONT DOOR SEAL CASTING. DRG.NO. 01.01.156 R3 ITEM-2 MATL. HEAT RESISTANT STEEL.	30	NO	1	30 30/07/14
5	FF8121011396 DRG: DRG.NO.01,01,155 R4. REV: FRONT DOOR SIDE SEAL CASTING. DRG. NO. 01.01.155 R4 MATL. HEAT RESISTANT STEEL	100	NO	1	100 30/07/14
6	FF8121011540 DRG: DRG.NO.01,01,011 R3. REV: SIDE, TOP & BOTTOM CASTING DRG NO.01 01 011 R3 MATL-H.R.STEEL	100	NO	1	100 30/07/14
7	FF8121011558	20	NO	1	20 30/07/14

Page No 1

★ महत्वपूर्ण : कृपया कोटेशन देने से पूर्व पीछे दिए गये अनुदेशों को ध्यानपूर्वक पढ़िये।

IMPORTANT : PLEASE READ CAREFULLY THE INSTRUCTIONS GIVEN ON REVERSE BEFORE SUBMITTING

राम शिवाजी  
20/



निविदा सूचना  
**TENDER ENQUIRY**

भारत हैवी इलैक्ट्रिकल्स लिमिटेड  
**Bharat Heavy Electricals Ltd**  
सेन्ट्रल फाउन्ड्री फॉर्ज प्लांट- हरिद्वार - २४६४०३ (भारत)  
**Central Foundry Forge Plant, Haridwar-249403 (INDIA)**

Phone : (0091) 01334- 281639,281385,285336 Fax : 01334 225892 / 226458

TIN NO. 05001763485  
C S T NO. HR-5018287 Dt. 16-03-1995

निविदा सूचना सं. ENQUIRY NO.*	<b>4411 P/ 360/3/0578F1</b>	दिनांक Date	<b>20-03-2014</b>
-------------------------------	-----------------------------	-------------	-------------------

कृपया निम्नलिखित के लिए निविदा दें | PLEASE QUOTE FOR THE FOLLOWING :

**MATERIAL CODE QUANTITY UNIT LOTNO**  
**ITEM DESCRIPTION**

DRG: DRG.NO. 01,01,012 R5. REV:  
CORNER CATING  
DRG NO.01,01,012 R5  
MATL-H.R.STEEL

\*\* IMPORTANT: This enquiry is 2 part tender. Techno-Commercial bid (Part-1) & Price Bids (Part-2) should be submitted in separate envelopes. These two envelopes should be submitted in a common sealed envelope. Techno-Commercial Bid shall contain detailed Technical Specification, Drawings Technical documents, Catalogues, taxes & duties, payment terms, delivery period, Validity of offer, Replica of Price Bid (Copy of price bid without price part) etc. The confirmation to the special terms & conditions must be submitted alongwith Techno-Commercial bid.

Standard Instructions:  
GUARANTEE CERTIFICATE REQUIRED.  
BASIC RATES, TAXES DUTIES SEPERATELY  
CENVATABL DUPLICATE COPY OF INVOICE.  
INSP AFTER RECPT AT CFFP.

*(\*) Delivery schedule mentioned in above T.E is tentative, actual delivery schedule will be as per point no 5 of annexure-1 of Commercial Term*

Special Instructions:  
GURANTEE CERTIFICATE IS REQUIRED FOR THE PERIOD OF ONE YEAR.  
PLEASE PROVIDE ONE INTEGRAL TEST PIECE/SAMPLE FOR EACH HEAT AT THE TIME OF DELIVERY.  
EARLY DELIVERY IS ALSO ACCEPTABLE.

*20/3/14*

**General Instructions:**

1. Please submit authorization letter (format enclosed) for facilitating e-payment/electronic transfer of funds
2. 100% payment within 30 days after receipt & acceptance of material at CFFP BHEL, Hardwar through e-payment.
3. CFFP/BHEL RESERVES THE RIGHT TO PRE-INSPECT THE MATERIAL AT VENDOR'S WORKS / GODOWN/ PREMISES BEFORE DESPATCH.
4. ORIGINAL MANUFACTURER'S TEST CERTIFICATE IS REQUIRED ALONG WITH DESPATCH DOCUMENTS. IN CASE SUPPLIES ARE FROM TRADERS, IT SHALL BE THE RESPONSIBILITY OF THE TRADER TO PROVIDE ORIGINAL MANUFACTURER'S TEST CERTIFICATE WITH LINKAGE TO TRADER'S INVOICE STATING BATCH NO.
5. CFFP/BHEL Reserves the right to procure from more than one vendor.
6. Please quote prices in figures & words both. In case the prices quoted in words and figures are different, the values indicated in words will be considered for evaluation & establishing L1 status.

\* The offers of the bidders who are on the banned list as also the offers of the bidders, who engage the services of the banned firms, shall be rejected. The list of banned firms is available on web site www.bhel.com

\* महत्वपूर्ण : कृपया कोटेशन देने से पूर्व पीछे दिए गये अनुदेशों को ध्यानपूर्वक पढ़िये।  
IMPORTANT : PLEASE READ CAREFULLY THE INSTRUCTIONS GIVEN ON REVERSE BEFORE QUOTING



AA-17001

निविदा सूचना  
**TENDER ENQUIRY**

भारत हैवी इलैक्ट्रिकल्स लिमिटेड  
**Bharat Heavy Electricals Ltd**

सेन्ट्रल फाउन्ड्री फॉर्ज प्लांट- हरिद्वार - २४६४०३ (भारत)

**Central Foundry Forge Plant, Haridwar-249403 (IND)**

Phone : (0091) 01334- 281639,281385,285336

Fax : 01334 225892 / 226458

TIN NO. 05001763485

C S T NO. HR-5018287 Dt. 16-03-

निविदा सूचना सं. ENQUIRY NO.\*

**4411 P/ 360/3/0578F1**

दिनांक Date

**20-03-2014**

कृपया निम्नलिखित के लिए निविदा दें। PLEASE QUOTE FOR THE FOLLOWING :

MATERIAL CODE	QUANTITY	UNIT	LOTNO
ITEM DESCRIPTION			

राज किशोर  
**RAJ KISHORE**  
**MANAGER**

20/3/14

**COMMERCIAL TERMS & CONDITIONS****Tender Enquiry No.: 4411P/360/3/20130578F1**

	Conditions	Vendor's Confirmation / Comments.
1	Guarantee Certificate shall be provided for the period of one year by the vendor.	
2	Test Certificate (with linkage to supplied material) shall be provided along with dispatch documents.	
3	Final inspection of material will be done after receipt of material at CFFP. All the charges (like To & Fro freight, insurance etc.) for replacement shall be borne by supplier. Date of receipt of replacement material if accepted shall be considered as actual delivery date with respect to the PO delivery date for calculating penalty for Late Delivery.	
4	<p><b>Delivery Term :-</b></p> <p>A. <u>For Indian Suppliers:</u> FOR, Destination (Door delivery basis). Destination will be CFFP, BHEL, Haridwar.</p> <p>B. <u>For Foreign suppliers:</u> On CIF, Nhava Sheva , Mumbai Quoted rate should be inclusive of the charges like freight, service tax on freight, insurance, packing &amp; forwarding etc. for the delivery term given above or else proper loading shall be done.</p>	
5	<p><b>Delivery Schedule :-</b></p> <p>A. For Indian Suppliers: In one lot within 60 days from P.O. date</p> <p>B. For Foreign suppliers: In one lot F.O.B. delivery–within 30 days from L.C./P.O. date, whichever is later. L.D. will be applicable as per above mentioned delivery Schedule. Vendor is requested to quote earliest possible delivery schedule.</p>	
6	<p><b><u>Conditions for opening of Price :-</u></b></p> <ol style="list-style-type: none"> <li>BHEL reserves the right to go for Reverse Auction (RA) instead of opening the sealed envelope price bid, submitted by the bidder. This will be decided after techno-commercial evaluation. All bidders to give their acceptance for participation in RA. Non-acceptance to participate in RA may result in non-consideration of their bids, in case BHEL decides to go for RA.</li> <li>In case BHEL decides to go for Reverse Auction, Only those bidders who have given their acceptance to participate in RA will be allowed to participate in the Reverse Auction. Those bidders who have given their acceptance to participate in Reverse Auction will have to necessarily submit „online sealed bid“ in the Reverse Auction. Non-submission of „online sealed bid“ by the bidder will be considered as tampering of the tender process and will invite action by BHEL as per extant guidelines in vogue.</li> <li>In case BHEL decides to go for Reverse Auction, the H1 bidder (whose quote is highest in online sealed bid) may</li> </ol>	

	not be allowed to participate in further RA process.	
7	<p>Payment Terms: <b>For Indian suppliers</b> - 100% within 30 days after receipt &amp; acceptance of material at CFFP / BHEL, Haridwar through e-payment. In case vendor does not agree, proper loading shall be done</p> <p>Loading will be @ Base rate of SBI (as applicable on the dated of bid opening, Techno-commercial bid opening in case of two part bids) + 6%, shall be considered for loading for the period of relaxation sought by bidders.</p> <p><b>For foreign suppliers:</b> Payment through USANCE LC on 70th day of bill of lading date. All bank charges shall be to vendor's account. In case vendor does not agree, proper loading shall be done. Loading will be @ Base rate of SBI (as applicable on the dated of bid opening, Techno-commercial bid opening in case of two part bids) + 6%, shall be considered for loading for the period of relaxation sought by bidders.</p>	
8	Validity of offers : minimum 90 days from tender opening date	
9	Evaluation of price bids will be done on the basis of total delivered cost at CFFP i.e. Landed cost net of Cenvat at CFFP.	
10	BHEL may place order for part quantity. Quoted rate not to be linked with order quantity.	
11	Rates shall be Firm till execution of purchase order.	
12	Material will be supplied as per delivery schedule required in tender enquiry / PO (FOR destination basis). Any request for extension in delivery schedule of Purchase Order / waiver of LD is liable to be ignored.	
13	<p>Normal clauses for imposing Penalty, Liquidated Damages for Late Delivery, Risk purchases, Cancellation, Arbitration in case of delay in effecting supply and or other defaults as per following conditions will be applicable:</p> <p>a. Penalty for Late Delivery: The delivery of the goods shall be made strictly as per time limit specified in delivery schedule, failure to supply within this period will make the seller liable to a penalty of 1/2 (half) percent of the price of the goods in arrears per week subject to a maximum of 10% on <b>the basic rate (total PO value)</b>. Any correspondence regarding waiver of LD shall not be entertained. In case supplier does not agree for LD clause, BHEL will load maximum penalty under LD clause, to the extent the same is not agreed by the vendor, for the purpose of comparative statement. Where deliveries quoted are not suiting, BHEL may ignore the offer.</p> <p>b. Risk Purchase: In case of delays in supplies / defective supplies or non-fulfillment of any other terms and conditions given in the Purchase Order by the seller, the Buyer reserves the right to cancel the purchase order in full or part thereof, and may also make the purchase of such material from alternative source <u>at the risk and cost of the seller.</u></p>	

14	For new vendors who are not registered with CFFP BHEL Haridwar, duly filled up "Supplier Registration Form" (available at www.bhel.com) along-with all the supporting documents has to be submitted along-with techno-commercial bid of offer. Please confirm that SRF is being submitted with your offer if applicable. However please note that if in any case duly filled up SRF along-with all the supporting documents is not received within 15 days of tender opening, your offer may liable to be ignored.	
15	BHEL will prefer to deal directly with foreign vendor/ original manufacturer. In case, vendor engages any Indian agent or take service of any Indian agent, copy of agent agreement required along with offer in line with Annexure-IV attached.	
16	In the event of any dispute arising out of contractual obligation, the order being finalized at Haridwar, India will be subject to Indian Laws and falls under jurisdiction of the court of Law at Haridwar, India.	
17	Indian Vendors shall quote their price only in INR. Foreign vendors shall quote their price only in USD, EURO, UK POUND STERLING and JAPANESE YEN.  For evaluation of price bids, exchange rate (TT selling rate of SBI) as on scheduled date of tender opening (Part-1 bid in case of two part bid) shall be considered.	
18	Vendor shall quote price both in words & figures. If there is any difference between price quoted in words & figures, price quoted in words shall prevail and binding.	
19	Please confirm to provide one integral test piece/sample for each heat at the time of delivery.	
20	Please provide contact person name, telephone nos. , fax no. & email id.	
21	A. In case of any difference in conditions quoted above & elsewhere in the offer, terms quoted above shall be treated as final and binding on vendor.  B. Evaluation shall be on the basis of delivered cost (i.e.) "total cost to BHEL".  C. Non acceptance of any of the above conditions may result in rejection of your offer.  D. Terms & Conditions not specified above will be as per Annexure-B No GTCRM NO. 01 Rev.05 Date: 25.10.12 enclosed.  E. In case of blank / no comments in provided remark column, it shall be deemed to have been accepted by vendor.	

Date:

Signature with Name of authorized signatory)

Seal of the Company

## **PRE QUALIFICATION CRITERIA**

**Ref: Open tender enquiry no. 4411P/360/3/20130578F1 for different types of castings**

This criteria governs the techno-commercial requirement for supply of all type of castings mentioned in the requirement. Offer of only those bidders will be considered who shall qualify following criteria (clause 1 to 5) and submit the documentary proof against each criterion wherever required.

<b>S.No.</b>	<b>Requirements</b>	<b>Vendor's Response</b>
1.	The annual sales of the vendor should be Rs. 1.0 Crore or above for twice in last five years. Party must submit copy of PAN card, Income Tax Return for last five years & Audited balance sheet of last five years. In case vendor is found solvent, BHEL may cancel the offer/PO at any stage without any binding on BHEL.	
2.	Vendor is required to provide the documentary evidence of successfully executed orders of castings in last five years.	
3.	The integral test piece / sample of each heat pertaining to our material may be required to provide with its laboratory test report at the time of delivery.	
4.	The vendors who are new to CFFP BHEL Haridwar (i.e.,not having vendor code in CFFP vendor list) are required to submit the filled SRF (Supplier Registration Form ) along with all the documents required. The form can be downloaded through below link. <a href="http://www.bhel.com/vender_registration/pdf/Guidelines_to_Indian_Suppliers_SEARP2010Amdt_04for_web.pdf">http://www.bhel.com/vender_registration/pdf/Guidelines_to_Indian_Suppliers_SEARP2010Amdt_04for_web.pdf</a> The offer is liable to be ignored/ rejected if "new" vendor fails to submit the SRF with the offer.	
5.	BHEL reserves the right to verify the information provided by the vendor. In case the information provided by the vendor is found to be false/ incorrect, the offer will be rejected.	

GENERAL TERMS AND CONDITIONS OF TENDER ENQUIRY  
ANNEXURE-B

01 Submit the tender in two parts i.e.

**Part-I Techno-Commercial Bid**

**Part-II Price Bid**

Techo - Commercial (part one) Price Bid (part two) should be put in separate sealed envelopes. Both envelopes should be super scribed with **Tender Number, Date of opening & Technical / Commercial Bid and Price Bid** respectively along with name of firm.

Both the envelopes i.e. containing Techno-Commercial Bid and Price Bid should again be kept in one envelope super scribed again with Tender No. and Date of opening and the name of firm submitting the tender and send it to **AGM (MM), Purchase Department, CFFP/BHEL, Hardwar, Ranipur, Hardwar 249403, Uttarakhand, India before due date / tender opening date & time**. Normally tender opening time is 2.00 PM on due date or as mentioned in enquiry.

**Responsibility for submission of tender in time solely lies with vendor. Late offers received after specified time / Date shall not be considered.**

1. Part-I Envelopes super scribed with **Techno-Commercial Bid** must contain all information especially-
  - (a) Specification of the material offered should be strictly as per CFFP/BHEL specifications of enquired material in tender documents **Deviations if any must be indicated clearly in the offer. Rates to be quoted on For Destination Basis.**
  - (b) All commercial terms i.e. packing, forwarding Custom duty, Additional Duty, ST/STT/VAT/CST, Excise Duty/CVD. Bank charges, payment terms & insurance etc as applicable (**except price**) should be clearly mentioned in Techno-Commercial bid. Also mention present rate of applicable taxes & duties even if inclusive in rates along with the concessional forms required if any.
  - (c) Confirm to submit all required commercial documents (tax invoice centvatable duplicate copy of invoice, packing list, transit sale agreement etc.) & technical documents (TC/GC/QP etc).
  - (d) Registration Numbers of SSI, Central Excise, Sales tax, Income Tax, DGS & D.ECC etc.
  - (e) **Un-priced copy of Price Bid.**

Part-II Envelopes super scribed with Price Bid should contain priced copy of Price Bid. The price should be mentioned both in figures and words.

2. Authorized Signatory should authenticate all tender documents.
3. **Techno-commercial bid (Part-I)** will be opened on the due date at 2.00 PM in the presence of participating vendors or authorized representatives, who may wish to be present. Representative deputed to witness tender opening must produce an authority letter from the signatory of offer. After evaluation of technical bids & finalization of technical, commercial terms & conditions, price bid of only successful vendors will be opened. Priced bid opening date shall be intimated separately.
4. The material offered must conform to the required BHEL specifications and drawings as well as instructions and details made available.
5. For new vendors, Vendor Registration from duly filled must be submitted along with the offer which can be downloaded from our web site [www.bhel.com](http://www.bhel.com) or [www.bhelhwr.co.in](http://www.bhelhwr.co.in).
6. Original manufacturer's Test Certificate is required along with dispatch documents. In case supplies are from traders, it shall be the responsibility of the trader to provide original manufacture's test certificate with linkage to traders invoice stating batch no.
7. **Validity** of offers should be minimum 90 working days from the date of tender (Techno-Commercial Bid) opening.

8. **Delivery** in the promised period is the essence of contract. Confirm to supply according to delivery schedule mentioned.
9. **Payment terms:**  
For indigenous suppliers: 100% within 30 days after receipt & acceptance of material at CFFP / BHEL, Haridwar through e-payment.  
For foreign suppliers: Payment through USANCE LC on 70<sup>th</sup> day of bill of lading date. All bank charges shall be to vendor's account.  
  
\* In case vendor does not agree, proper loading shall be done. Also in that case, third party inspection shall have to be arranged by supplier from any of the five inspection agencies namely: LRS/ BVQI/ DNV/ TUV/ Alfred H Knight at their cost.
10. CFFP/BHEL, Hardwar reserves the right to accept or reject any or all tenders without assigning any reason thereof.
11. Tenders not submitted in the prescribed manner are likely to be ignored / rejected.
12. Agent/Agency Commissioning: Payment of any kind at any stage will not be made to agent on account of agent commission or otherwise by CFFP/BHEL, Hardwar.
13. CFFP/BHEL, Hardwar may opt for E-auction/Reverse auction for obtaining best prices for part or full tendered quantity. BHEL also reserve the right to negotiate price with L1 vendor after reverse auction.
14. Please do intimate the personal contact details like Name, Mobile Number, Email-id etc of authorized executive for correspondence.
15. **Penalty:** Orders placed against this enquiry will be subject to normal clauses for imposing penalty. Liquidated Damages, Risk purchases, cancellation, arbitration as per terms and conditions of Tender Enquiry and Purchase orders in case of delay in effecting supply and/ or other defaults.  
**Liquidated damage:** The delivery of the goods shall be made strictly as per time limit specified in delivery schedule, failure to supply within this period will make the supplier liable to an conditional penalty of 1/2 (half) percent of the price of the goods in arrears per week subject to a maximum of 10%.
16. **Inspection:** Final inspection of material shall be done after receipt of material at CFFP/BHEL, Hardwar. Acceptance of material shall be after final inspection and shall be binding. However, CFFP reserves the right to pre Inspect the material at supplier works. In case material is found defective during warranty period, the same will be returned for repair and/ or replacement. For this vendor has to bear all the charges such as Freight, to and fro insurance etc. Bank Guarantee for the equal amount to the cost of the item is to be furnished by vendor. In case the repair is done at CFFP/BHEL the amount on actual shall have to be reimbursed by the Vendor and or adjusted on actual from their bill.
17. **Currency of Payment:** Mention the currency in which payment has to be made. For evaluation of price bids, exchange rate (TT selling rate of SBI) as on scheduled date of tender opening (Part-1 bid in case of two part bid) shall be considered.
18. Traders should submit authorization letter from their principal alongwith offer.
19. Disputes: In event of any dispute arising out of contractual obligation, the order being finalized at Hardwar, India will be subject to Indian Laws and falls under jurisdiction of the court of Law at Haridwar, India. The overseas supplier hereafter referred to as "Vendor" shall therefore abide by the verdict of Court of Law at Hardwar, India.  
OR  
All disputes arising out of or in connection with the present contract, if any shall be finally settled under the rules of arbitration of International chamber of commerce by one or more arbitrator appointed in accordance with the said Rules in India.
20. BHEL reserves the right to place P.O. for part / full qty and on one or more than one sources.
21. Any Term & condition of the specific tender (if specified in tender & contradicts with above term) will supersede the above general terms & conditions.

**Terms and conditions regarding Indian agent of foreign suppliers:**

01. BHEL shall deal directly with foreign vendors, wherever required, for procurement of goods. However, if the foreign principal desires to avail of the services of an Indian agent, then the foreign principal should ensure compliance to regulatory guidelines- which require mandatory submission of an Agency agreement.
02. It shall be incumbent on the Indian agent and the foreign principal to adhere to the relevant guidelines of Government of India, issued from time to time.
03. The agency agreement should specify the precise relationship between the foreign OEM/Foreign principal and their Indian agent and their mutual interest in the business. All services to be rendered by agent/associate, whether of general nature or in relation to the particular contract, must be clearly stated by the foreign supplier / Indian agent. Any payment, which the agent or associate receives in India or aboard from the OEM, whether as commission or as a general retainer fee should be brought on record in the agreement and be made explicit in order to ensure compliance to laws of the country.
04. Any agency commission to be paid by BHEL to the Indian agent shall be in Indian currency only.
05. Tax deduction at source is applicable to the agency commission paid to the Indian agent as per the prevailing rules.
06. In the absence of any agency agreement, BHEL shall not deal with any Indian agent (authorized representatives/ associate/consultant, or by whatever name called) and shall deal directly with the foreign principal only for all correspondence and business purposes.
07. The "Guidelines for Indian Agents of Foreign Suppliers" enclosed at annexure- 'A' shall apply in all such cases.
08. The supply and execution of the Purchase Order (including indigenous suppliers/service) shall be in the scope of the OEM/ Foreign principal. The OEM/ Foreign principal should submit their offer inclusive of all indigenous suppliers/services and evaluation will be based on 'total cost to BHEL'. In case OEM/ foreign principal recommends placement of order(s) towards indigenous portion of supplies/services on Indian Supplier (s)/ agent on their behalf, the credentials/capacity/capability of the Indian Supplier (s)/ agent to make the supplies/Services shall be checked by BHEL as per the extant guidelines of Supplier Evaluation, Approval and Review Procedure (SEARP), before opening of price bids. In this regards, details may be checked as per Annexure- 'B' (copy enclosed). It will be the responsibility of the OEM/ Foreign Principal to get acquainted with the evaluation requirements of Indian supplier/agent as per SEARP available on [www.bhel.com](http://www.bhel.com).

The responsibility for successful execution of the contract (including indigenous supplies/services) lies with the OEM/ foreign principal. All bank guarantees to this effect shall be in the scope of the OEM/Foreign principal.

**Guidelines for Indian Agents of Foreign Suppliers**

- 1.0 There shall be compulsory registration of agents for all Global (Open) Tender and Limited Tender. An agent who is not registered with BHEL shall apply for registration in the registration form in line with SEARP.
  - 1.1 Registered agents will file an authenticated Photostat copy duly attested by a Notary Public/Original certificate of the Principal confirming the agency agreement and giving the status being enjoyed by the agent and the commission/ remuneration/ salary/ retainership being paid by the principal to the agent before the placement of order by BHEL.
  - 1.2 Wherever the Indian representatives have communicated on behalf of their principals and the foreign parties have stated that they are not paying any commission to the Indian agents, and the Indian representative is working on the basis of salary or as retainer, a written declaration to this effect should be submitted by the party (i.e. Principal) before finalizing the order.
- 2.0 Disclosure of particulars of agents/ representatives in India, if any.**
- 2.1 Tenderers of Foreign nationality shall furnish the following details in their offers:
    - 2.1.1 The Bidder(s)/ Contractor(s) of foreign origin shall disclose the name and address of the agents/ representatives in India if any and the extent of authorization and authority given to commit the Principals. In case the agent/ representative be a foreign Company, it shall be confirmed whether it is existing Company and details of the same shall be furnished.
    - 2.1.2 The amount of commission/ remuneration included in the quoted price(s) for such agents/ representatives in India.
    - 2.1.3 Confirmation of the Tenderer that the commission/ remuneration, if any, payable to his agents/ representatives in India, may be paid by BHEL in Indian Rupees only.
  - 2.2 Tenderers of Indian Nationality shall furnish the following details in their offers:
    - 2.2.1 The Bidder(s)/ Contractor(s) of Indian Nationality shall furnish the name and address of the foreign principals, if any, indicating their nationality as well as their status, i.e. whether manufacturer or agents of manufacturer holding the Letter of Authority of the Principal specifically authorizing the agent to make an offer in India in response to tender either directly or through the agents/ representatives.
    - 2.2.2 The amount of commission/ remuneration included in the price (s) quoted by the Tenderer for himself.
    - 2.2.3 Confirmation of the foreign principals of the Tenderer that the commission/ remuneration, if any, reserved for the Tenderer in the quoted price(s), may be paid by BHEL in India in equivalent Indian Rupees on satisfactory completion of the Project or supplies of Stores and Spares in case of operation items.
  - 2.3 In either case, in the event of contract materializing, the terms of payment will provide for payment of the commission/ remuneration, if any payable to the agents/ representatives in India in Indian Rupees on expiry of 90 days after the discharge of the obligations under the contract.
  - 2.4 Failure to furnish correct and detailed information as called for in paragraph 2.0 above will render the concerned tender liable to rejection or in the event of a contract materializing, the same liable to termination by BHEL. Besides this there would be a penalty of banning business dealings with BHEL or damage or payment of a named sum.

---X---

This format is applicable only to Indian Suppliers/ Agents supplying indigenous portion of Foreign Purchases.

\* In all other cases, extant guidelines of SEARP, 2010 are to be followed.

SEARP (SRF) Clause No	Detail
	<b>Name &amp; address of the firm</b>
<b>1.0</b>	<b>Products/ Systems / Services being considered for</b>
<b>2.0</b>	<b>General Information</b>
2.2	Name of Chief Executive
2.3	Details of authorized signatory
<b>3.0</b>	<b>Ownership Information</b>
3.1	Type of firm
3.2	Nature of Business <ul style="list-style-type: none"> <li>• <i>Attach <b>authorization letter</b> and <b>agency agreement</b> from Principal ( from whom capital equipment is procured)</i></li> <li>• <i>Attach copy of declaration from Foreign Principal for <b>total guarantee/ warranty of indigenous supplies</b></i></li> </ul>
3.3	Year of establishment
3.4	Year of commencement of business
<b>4.0</b>	<b>Registration particulars</b>
4.1	Permanent Account No.
4.2 / 4.3	Sales Tax / TIN no
4.6	Service tax no. (in case of E&C)
<b>5.0</b>	<b>Organisational strength</b>
<b>6.0</b>	<b>Other particulars</b>
6.1	If the company is already registered with other units
6.2	Directors/ Partners, if related to any BHEL Employee
6.9	If any Ex BHEL Personnel employed by the Company
6.12	Details of pending legal issues with BHEL
6.13	Bank Account information
<b>9.0</b>	<b>Financial information</b>
9.6	Sales/ Turnover details of last 3 years (or from the date of incorporation whichever is less )

---X---

AUTHORISATION LETTER  
FOR E-PAYMENT/ELECTRONIC FUNDS TRANSFER (EFT/RTGS)  
PLEASE FILL UP THE FORM IN CAPITAL LETTERS ONLY

ANNEXURE-D  
Page 1 of 1

TYPE OF REQUEST (Tick One)	<input type="checkbox"/>	CREATE	<input type="checkbox"/>	CHANGE
BHEL Vendor/ Supplier Code	<input type="text"/>			
Company's Name	<input type="text"/>			
Address	<input type="text"/>			
City	<input type="text"/>			
Pincode	<input type="text"/>			
State	<input type="text"/>			
Contact Person(S)	<input type="text"/>			
Telephone NO.	<input type="text"/>			
FAX. No.	<input type="text"/>			
e-mail id	<input type="text"/>			
1. Bank Name	<input type="text"/>			
2. Bank Address	<input type="text"/>			
3. Bank Telephone No.	<input type="text"/>			
4. Bank Account No.	<input type="text"/>			
5. Account Type.	<input type="text"/>			
6. Bank's Branch Code	<input type="text"/>			
7. Bank Swift Code	<input type="text"/>			
(aplicable to EFT only)				
8. Enclose blank cancelled cheque	<input type="checkbox"/>	<input type="checkbox"/>		

DECLARATION

1. I as representative/Owner of the above named company, hereby authorize BHEL CFFP, Ranipur, Haridwar to electronically make payments to the designated bank account. I hereby certify that the particulars given above are true, complete and correct.  
(2) If the transsation is delayed or not effected at all for reasons of incomplete or incorrect information, I would not hold BHEL/transfereing Bank responsible.
3. This authority remains in full force untill BHEL, CFFP, Ranipur, Haridwar receives & acknowledge written notification requesting a change or cancellation.
4. I have read the contents of the covering letter and agree to discharge the responsibilty expected of me as a participant under E-payment/EFT/RTGS.

Date:

Authorized Signatory  
Designation

Company Seal

Verification By Bank

FIRST ANGLE PROJECTION (ALL DIMENSIONS ARE IN MM)

BOGIE CURB CASTING

DRG NO. TO BE EMBOSSED HERE

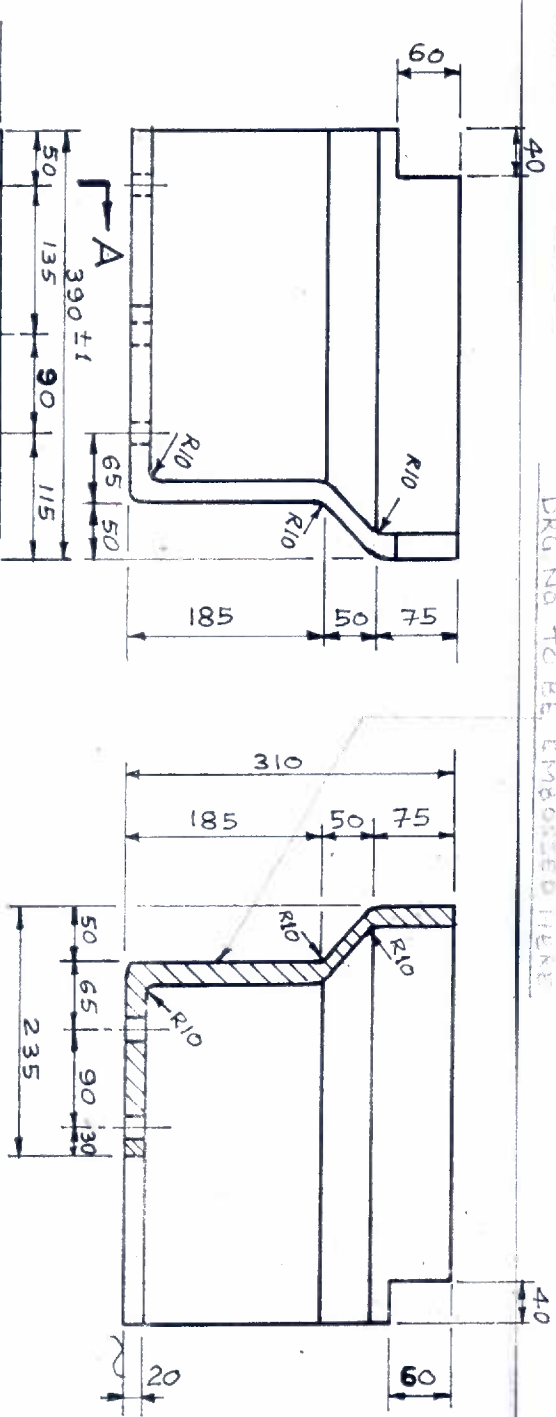

SECTION-A-A

ACT. DESIGN	UNDES. No	ASTM SPEC	C	S	P	SI	Mn	NI	CR	MO	N	Fe
HEAT RESISTANT STEEL	J2165A	297.1608	<	<	0.04	2.0	1.0	0.05	0.05	0.15		
	J92805A	297.1608	<	<	0.04	1.5	2.0	0.05	0.05	0.15		
	HE 921051A	297.1608	0.2	"	0.5	1.5	2.0	0.8	1.5	2.0		
			3.1	"	0.5	1.5	2.0	0.8	1.5	2.0		
			3.5	"	0.5	1.5	2.0	0.8	1.5	2.0		

312148  
WESMAN FURNACE

The information on this document is the property of BHARAT HEAVY ELECTRICALS LIMITED. It must not be used directly or indirectly in any way detrimental to the interest of the company.

NOTE: SURFACES MARKED  $\nabla$  TO BE SMOOTH FINISHED BY SHOT BLASTING OR GRINDING.

PLEASE DO NOT REMOVE ANY PART OF THE SURFACE OF THE CASTING UNLESS SPECIFIED OTHERWISE.

REV. DATE	BY	REASON	REV. DATE	BY	REASON
R2 24/11	...	...	F1 18/10	...	...

**BHARAT HEAVY ELECTRICALS LTD.**  
UNIT: C.F.P. HARDWAR.

TYPE OF PRODUCT: OR  
NAME OF CUSTOMER/PROJECT: ...

DEPT: DESIGN  
SCALE: 1:5  
WEIGHT (KG): 48.8

**CORNER CURB CASTING (TYPE-1)**

DRAWN: GUPTA  
CHECKED: SWAMINI  
APPROVED: ...

DRAWING NO: 01,01,018  
SHEET NO. 1

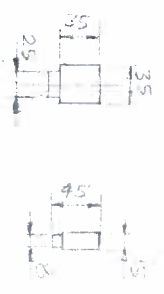

FIRST ANGLE PROJECTION ( ALL DIMENSIONS ARE IN mm )

REV	DATE	ALTERED	REASON	REV	DATE	ALTERED	REASON	REV	DATE	ALTERED	REASON
R1	11.7.81	CHECKED	Ashok	R2	11.7.81	CHECKED	P. I	R3	01.01.87	CHANGED	Paint

CHANGE THE MATERIAL  
TAP HOLES NOT REQUIRED

DRAWING TO BE EMBOSSED HERE

DOOR CASTING

WITH RECALCULATED  
 R5 24.10.81

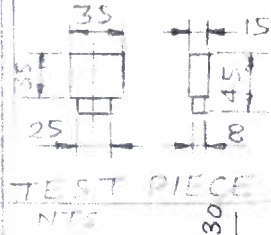
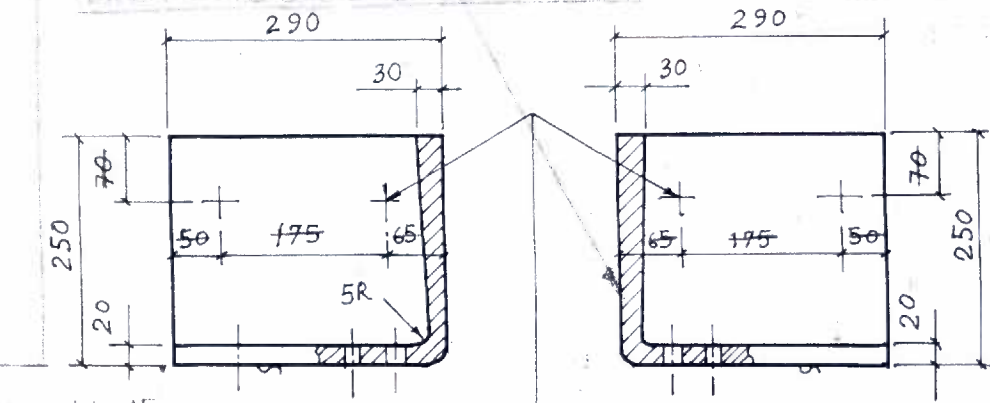

M12 TAPPED HOLES  
TO BE MADE ON 2 NOS.  
OF P. NO. 1

1. SURFACE TO BE SMOOTH  
FINISHED BY SHOT BLASTING  
OR GRINDING.  
2. TEST PIECE MAY BE CAST  
INTEGRALLY AT ANY SUITABLE/  
CONVENIENT PLACE OF EACH  
CASTING.

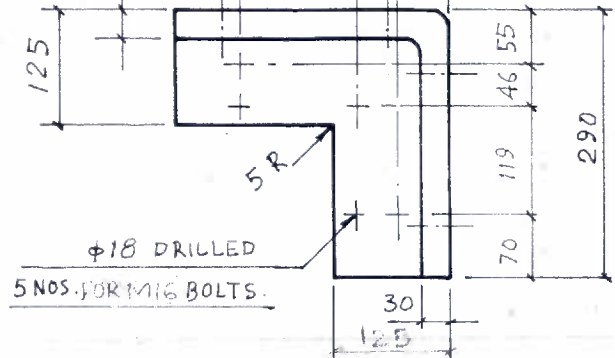

R4	HEAT RESISTANT STEEL											
ACI	GRADE	C	S	P	SI	Mn	Ni	Cu	Mo	N	Fe	
DESG.	UNS. NO.	ASTM	SPEC.	≤	≤	≤	≤	≤	≤	≤	REM.	
HC.	J92605	A277	A603	0.05	0.04	0.04	0.03	1.0	2.0	2.0	0.15	
HEAT RESISTANT C.I.												
3.1	-	-	2.0	-	0.8	1.5	-	-	-	-	-	
3.5	-	-	2.8	-	1.2	2.0	-	-	-	-	-	



**BHARAT HEAVY ELECTRICALS LTD.**  
UNIT: C.F.P., HARDWAR.

DEPT.	CODE	SCALE	WEIGHT (KG)	REF. TO ASSY. DRG.	ITEM NO.
		1:12.5 1:7.5	39.9		
CORNER CASTING P. NO. 1 10 & 7 M. FURNACE				DRAWN	NAME
				Ashok	Ashok
				CHECKED	DATE
				J. J. Swami	27.2.81
				APPROVED	
				V. C. R.	16.1.87
Dimensions to be Controlled Within Limits as Shown				DRAWING NO.	1515 REV. 17
Machining Tolerance + 25 mm Unless Otherwise Shown. Non Machining Tolerance +				01.01.012	5
SHEET NO. 1				NO. OF SHEETS.	

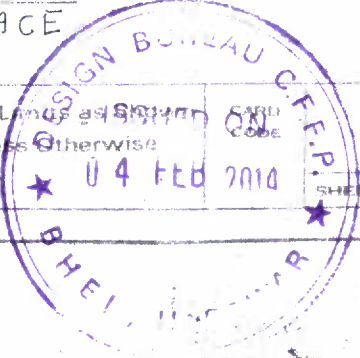

The information on this document is the property of BHARAT HEAVY ELECTRICALS LIMITED  
 It must not be used directly or indirectly in anyway detrimental to the interest of the company  
 312149 WESMAN  
 312149 WESMAN  
 312149 WESMAN  
 312149 WESMAN

FIRST ANGLE PROJECTION ( ALL DIMENSIONS ARE IN mm )

REV	DATE	ALTERED	REV	DATE	ALTERED	REV	DATE	ALTERED
1	24/10/91	Kishan Lal	2	24/10/91	Kishan Lal	3	24/10/91	Kishan Lal
		CHECKED			CHECKED			CHECKED
Change of the Mill			WT RECALCULATED					

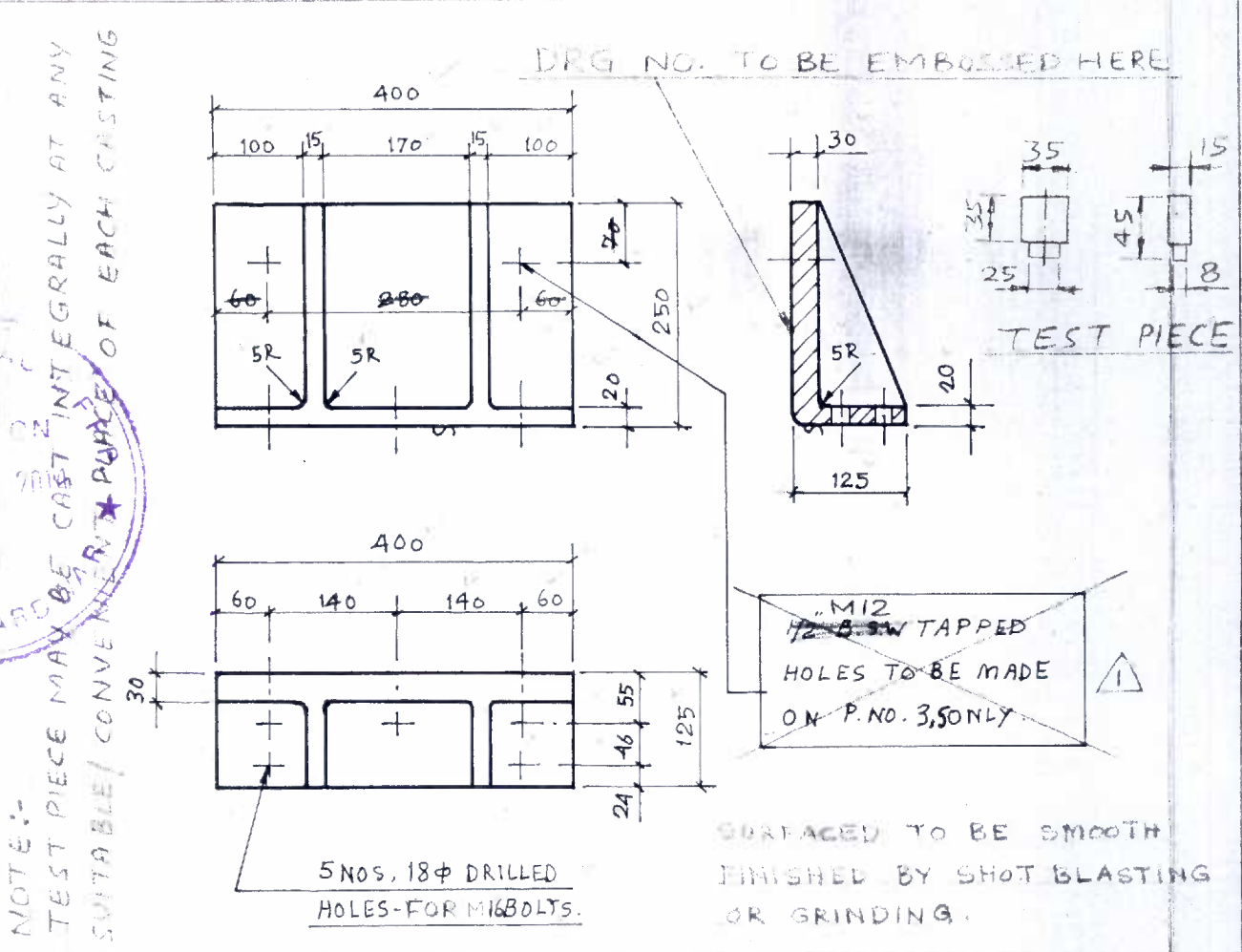

NOTE:- TEST PIECE MAY BE CAST INTEGRALLY AT ANY SUITABLE/ CONVENIENT PLACE OF EACH CASTING

5 NOS, 18φ DRILLED HOLES-FOR M16 BOLTS.

HEAT RESISTANT STEEL :-

ACI	GRADE	C	S	P	Si	Mn	Ni	Cr	Mo	N	Fe
DESIGN	UNS. NO. ASTM. SPEC.	≤	≤	≤	≤	≤	≤	≤	≤	≤	REM.
HC	J92605 A297-A608	0.5	0.04	0.04	2.0	1.0	2.0	26.0	0.5	0.15	

HEAT RESISTANT C.I

3.1	-	-	2.0	-	0.8	1.5	-	-	-
3.5	-	-	2.8	-	1.2	2.0	-	-	-

**BHARAT HEAVY ELECTRICALS LTD.**  
UNIT: C.F.F.P., HARDWAR.

DEPT.	CODE	SCALE	WEIGHT (KG)	REF. TO ASSY. DRG.	ITEM NO.
		1:12.5 1:7.5	31.8		
SIDE, TOP & BOTTOM CASTING TYPE: I P.NO. 2.3 & 5 7 M. FURNACE				NAME	SIGN.
				DATE	
				DRAWN	27-2-91
				CHECKED	24-91
				APPROVED	
Dimensions to be Controlled Within Limits as Shown				DRAWING NO.	15 16 REV. 17
Machining Tolerance + 25 mm Unless Otherwise Shown. Non Machining Tolerance ±				01.01.011	3
CARD CODE				SHEET NO.	NO. OF SHEETS, 1

The information on this document is the property of BHARAT HEAVY ELECTRICALS LIMITED. It must not be used directly or indirectly in any way detrimental to the interest of the company.  
 312149 WESMAN  
 Ref. Drg. No.  
 3121011/59  
 For HR ST  
 For HR STEEL  
 Inventory No.

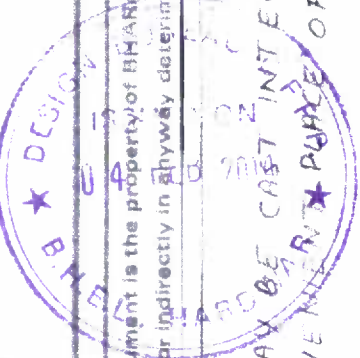



REV	DATE	BY	REASON
R3	24/10/11		
WT. RECALCULATED			

4 SLOTTED COUNTER BORE HOLE

DRG. NO. TO BE EMBOSSED HERE

4 SLOTTED COUNTER BORE HOLE

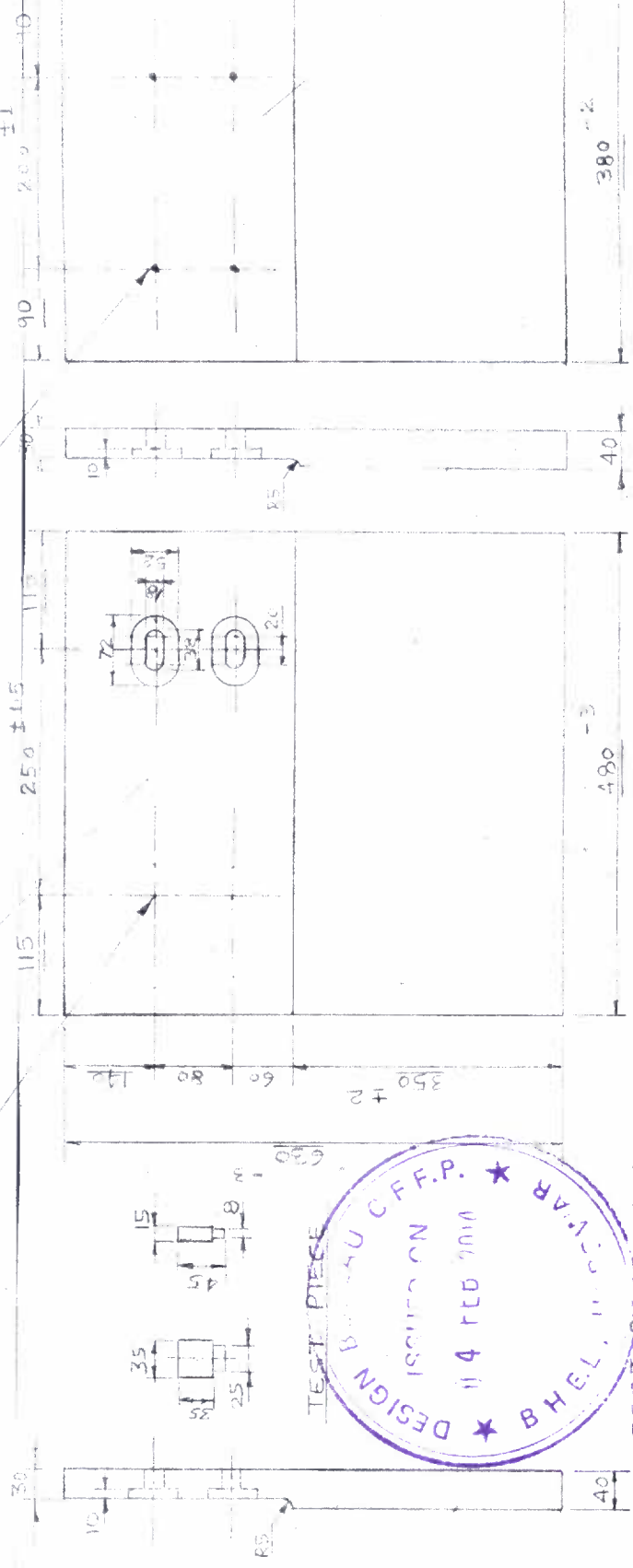

NOTE: TEST PIECE MAY BE CAST INTEGRALLY AT ANY SUITABLE/CONVENIENT PLACE OF EACH CASTING THESE CASTINGS TO BE USED IN LDO FIRED RH FURNACES (TEMP. 1750°C)

MATERIAL: HEAT - RESISTING STEEL.  
 COMP: C: 0.12, Si: 0.17, Cr: 30.0, Mn: 10.5, P: 0.004, S: 0.0015, N: 0.0015, Cu: 0.05  
 MAX. SERVICE TEMP.: 1150°C  
 MATERIAL: HEAT RESISTING C.I.  
 C: 3.1% - 3.5%, Si: 2% - 2.8%, Mn: 0.8% - 1.2%, Cu: 1.5% - 2%

NO	DISCRIPTIONS	ITEM 1	ITEM 2	QTY. REQD.
1.	7 M. W. R.H.F.	5	3	
2.	10 M. W. R.H.F.	2	4	
3.	8 X 6 X 3 M.H.F. (H.F.S)	1	3	
4.	10 M. VULCAN RHE	4	-	
5.	9 M. R.H.F. / H.F.S.	5	3	

NO	DISCRIPTIONS	ITEM 1	ITEM 2	QTY. REQD.
1.	7 M. W. R.H.F.	5	3	
2.	10 M. W. R.H.F.	2	4	
3.	8 X 6 X 3 M.H.F. (H.F.S)	1	3	
4.	10 M. VULCAN RHE	4	-	
5.	9 M. R.H.F. / H.F.S.	5	3	

NO	DISCRIPTIONS	ITEM 1	ITEM 2	QTY. REQD.
1.	7 M. W. R.H.F.	5	3	
2.	10 M. W. R.H.F.	2	4	
3.	8 X 6 X 3 M.H.F. (H.F.S)	1	3	
4.	10 M. VULCAN RHE	4	-	
5.	9 M. R.H.F. / H.F.S.	5	3	

**BHARAT HEAVY ELECTRICALS LTD.**  
 UNIT : CENTRAL FOUNDRY FORGE PLANT.  
 HARDWAR.

DPTT. P.E.	SCALE 1:1.5	WEIGHT (KGS) 82.8	DATE
TITLE	FRONT DOOR SEAL CASTING (FOR)		
	(MODIFICATION IN RH FURNACE)		
DRAMA WORKED	CHECKED	APPROVED	SIGN
DRAWING NO.			REV.
SHEET NO.			

DRAWING NUMBER

BOGIE CURB CASTING

REV

The information on this document is the property of BHARAT HEAVY ELECTRICALS LIMITED. It must not be used directly or indirectly in anyway detrimental to the interest of the company.

ITEM NO.	DESCRIPTION	QTY	UNIT	WEIGHT (KG)	TOTAL WEIGHT (KGS)
HC 3926	3117, 1.00	1.0	20	20	20
HD 3926	3117, 1.00	1.0	20	20	20
HE 3926	3117, 1.00	1.0	20	20	20

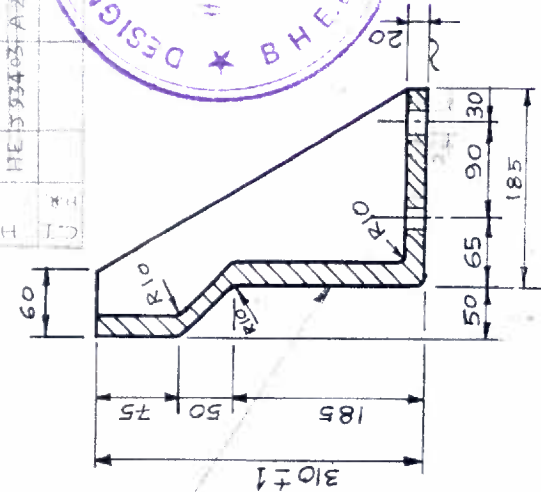

SECTION A-A

4 NOS. SLOTTED  
CORED HOLES  
34X22



NOTE: SURFACES MARKED WITH S TO BE SMOOTH FINISHED BY SHOT BLASTING OR GRINDING.  
TEST PIECE MAY BE CAST INTEGRALLY AT ANY SUITABLE CONVENIENT PLACE OF EACH CASTING.

REV DATE ALTERED BY  
R1 18/01/2010  
R2 18/01/2010  
R3 18/01/2010

WT. RECALCULATED & REORGANIZED

DIRECTION OF HOLES FROM VERTICAL (0) CHANGED TO HORIZONTAL (90)

TABLE

TYPE	X	Y	Z	WEIGHT PER PIECE
III	338	238	161	25.5 KGS.
IV	320	220	152	27 KGS.

MATL: C.I. (H.R.)

C - 3.1% - 3.5%  
Si - 2% - 2.8%  
Mn - 0.8% - 1.2%  
Cr - 1.5% - 2%



TYPE OF PRODUCT OR NAME OF CUSTOMER / PROJECT

**BHARAT HEAVY ELECTRICALS LTD.**  
UNIT: C.F.F.P., HARDWAR.

DEPT. CODE	SCALE	WEIGHT (KG)	REF. TO ASSY. DRG.	ITEM NO.
	1:5			
SIDE CURB CASTING		DRAWN: GUPTA		
TYPE III & IV		CHECKED: SWAMIT		
Dimensions to be Controlled Within Limits as Shown		APPROVED: [Signature]		
Machining Tolerance + 25 mm Unless Otherwise Shown, Non Machining Tolerance +		DRAWING NO. 01.01.019		
CARD CODE		1516 REV. 1		
SHEET NO. 1		NO. OF SHEETS. 1		

SIZE A3