



ಭಾರತ್ ಹೆವಿ ಎಲೆಕ್ಟ್ರಿಕಲ್ಸ್ ಲಿಮಿಟೆಡ್
भारत हेवी इलेक्ट्रिकल्स लिमिटेड

Bharat Heavy Electricals Limited

(A Government of India Undertaking)

ELECTRONICS DIVISION

P.B.No 2606, Mysore Road, Bangalore - 560 026

An ISO 9001, ISO 14001 & OHSAS 18001 Company

Gram : BHARATELEC
Telex : 0845-2436 BHCE IN
0845-8151 BHCE IN
Fax : 0091 80-26989219
RABMN : 40410000014

Dt.14.10.2014

**Addendum to RFQ : HBSBOS016 RFQ Due Date: 15.10.2014
for 66kV S/Y – Mandya, KPCL**

Following revisions / modifications are incorporated in the Tender document :

- 1. Corrigendum to Purchase Specification PS-439-912(Page 1 enclosed).**
- 2. Due date for the tender is revised to 22.10.2014.**

All other terms and conditions of RFQ remain unchanged.

Sr.MANAGER (SC&PV/MM)

पंजीकृत कार्यालय : ' भेल हाउस ', सिरी फोर्ट , नई दिल्ली – 110 049
Regd. Office : BHEL House, Siri Fort, New Delhi – 110 049

	PURCHASE SPECIFICATION FOR DESIGN,SUPPLY, E&C AND O&M OF 66KV S/Y BAY AT 10MW, KPCL-BELAKAVADI,MANDYA	PS-439-912
		CORRIGENDUM-1
		PAGE : 1 OF 1

Corrigendum-1 to purchase specification PS-439-912 Rev. 00

#	Tender clauses	Description as in tender	Revised description as per this Corrigendum
1	3.1.2 in page 3 of 64	Supply of fire-fighting equipment and fire hydrant system for 12.5 MVA transformer.	To be read as "Supply of fire-fighting equipment and nitrogen fire protection system for 12.5 MVA transformer."
2	4.9, d (iii) in page 9 of 64	Fire hydrant and sprinkler system: As per CBIP norms.	To be read as "Nitrogen Injection fire protection system"
3	SLD attached (Drawing No. 3-679-05-00737)	66KV Isolators (2 Nos.) rating is mentioned as 630 A.	66KV isolators (2 Nos.) rating shall be read as 1250A.

Bharat Heavy Electricals Ltd
Electronics Division
Mysore Road, Bangalore – 560 026

**Tender Documents for Design, Supply, Erection and Commissioning,
O&M for 66kV S/Y for KPCL-Mandya 10MWp SPV plant**

RFQ Ref: HSBOS016
RFQ Due Date: 10.10.2014

This Tender Document Contains:

- (1) Request For Quotation
- (2) Technical Specifications : PS- 439-912
- (3) Enclosures B,B1&B2 : Commercial Terms & Conditions, Unpriced Bid Format and Price Bid Format
- (4) General Terms and Conditions (Doc Ref : SCPV/BOS/01-Rev 01)

Note:

Part – I: **To be submitted in a separate sealed cover.**

Part – II: **To be submitted in a separate sealed cover.**

Part-I & Part-II sealed covers should be put in outer envelope and super scribed with RFQ No., RFQ date and due date along with the Name & Address of the tenderer.

Tender document should be dropped in Tender drop box super scribed “**SC&PV/Friday**” kept in reception area of BHEL – Electronics Division, Bangalore.

For any clarification, the following may be contacted:

Mr. H B Srinivasa, Sr.Manager (SC&PV-MM)
Ph: 080-26998495/09449869655
e-mail : srinivasahb@bheledn.co.in

Ms. Iswarya Raveendran, Engineer (SC&PV-MM)
Ph : 080 26998113
e-mail : iswarya@bheledn.co.in

REQUEST FOR QUOTATION

	BHARAT HEAVY ELECTRICALS LIMITED Electronics Division PB No. 2606, Mysore Road Bangalore - 560026 INDIA	RFQ NUMBER: HBSBOS016 RFQ DATE : 17.SEP.2014	Due Date 10.OCT.2014 Time: 13:00 HRS VENUE : NEW ENGG. BLDG
MMI:PU:RF:003			

(for all correspondence)

Purchase Executive : SRINIVAS H B
 Phone : 26998452
 Fax : 00918026989217
 E-mail: srinivasahb@bheledn.co.in

Please submit your lowest quotation subject to our terms and conditions attached for the material mentioned below. The quotation must be enclosed in a sealed envelope / Fax superscribed with RFQ no.and due date, should reach us on or before the due date by **13.00** hours IST and will be opened on the same day at **13.30** hours at the venue mentioned above. **PLEASE DROP THE OFFER IN THE BOX PROVIDED AT RECEPTION.**

- 1.Submit offer in Two Parts- Technical & Price Bid. Refer General Terms & Conditions as per SC&PV- General Terms & Conditions (Page 1 to 14).
- 2.Technical Specification PS-439-912 Rev 00 enclosed.
- 3.Find attached Annexure B(Commercial Terms & Conditions),Annexure B1(Un Priced Bid Format) & Annexure B2 (Price Bid Format).
- 4.The dates indicated in Delivery Column of RFQ is tentative. Vendor to quote their delivery as indicated in Annexure B.

SI No.	Description	Qty	Unit	Delivery qty	Delivery Date
1	PS0679042610 Supply of 66KV switchyard bay AT 10MW KPCL As per specs.PS-439-912 Test Certificate	1	ST	1	20.JAN.2015
2	PS0679042628 E&C of 66KV switchyard bay at 10MW KPCL As PER SPEC PS-439-912	1	AU	1	16.MAR.2015
3	PS0679042636 O&M for 1st year of 66KV switchyard bay AT 10MW KPCL As PER SPEC PS-439-912	1	AU	1	16.MAR.2016
4	PS0679042644 O&M for 2nd year of 66KV switchyard bay AT 10MW KPCL As PER SPEC PS-439-912	1	AU	1	16.MAR.2017
5	PS0679042652 O&M for 3rd year of 66KV switchyard bay AT 10MW KPCL As PER SPEC PS-439-912	1	AU	1	16.MAR.2018

Total Number of Items - **5**

Please note that the tender will be opened in the presence of the bidders or his authorised representatives (maximum two per organisation) who choose to be present with authorisation letters. Refer annexure for the terms and conditions.

Please specify Terms of delivery, Excise duty, sales tax, Ex-BHEL, Ex-works surcharge, Insurance,P&F, Freight and other taxes very clearly .

For evaluation,exchange rate(TT selling rate of SBI) as on scheduled date of tender opening (Part-I bid incase of two part bid) shall be considered.

The offers of the bidders who are on the banned list as also the offer of the bidders, who engage the services of the banned firms, shall be rejected.The list of banned firms is available on BHEL web site www.bhel.com

- i). This is only RFQ not an order.
- ii). In all correspondence quote RFQ No. & due date.
- iii). In Quotation BHEL material code / RFQ Sl. No. should be mentioned clearly.
- iv). Quotation Envelope / Fax not superscribed with RFQ No.and due date is liable for rejection.
- v). Quotation should remain valid for a minimum peiod of 90 days from due date.
- vi). In case of non-receipt of Quotation or regret letter for 3 consecutive RFQs you are liable to be removed from our vendors list.
- vii). All Prices should be written in words and numbers.
- viii). Excise Chapter Heading should be mentioned for all items where VAT is applicable .

For and On behalf of BHEL.



**PURCHASE SPECIFICATION FOR
DESIGN,SUPPLY, E&C AND O&M OF 66KV S/Y BAY AT
10MW, KPCL-BELAKAVADI,MANDYA**

PS-439-912

REV NO: 00



PAGE : 1 OF 64

COPY RIGHT AND CONFIDENTIAL

The information on this document is the property of Bharat Heavy Electricals Limited.

It must not be used directly or indirectly in anyway detrimental to the interest to the company

**TECHNICAL SPECIFICATION FOR DESIGN, SUPPLY, ERECTION AND
COMMISSIONING, O&M FOR 66KV S/Y FOR 10MW, KPCL-BELAKAVADI, MANDYA**

Revision details :R 00	Prepared  BKC/LNK	Approved  SLR	Date 26/8/2014
------------------------	--	---	-------------------

	PURCHASE SPECIFICATION FOR	PS-439-912
	DESIGN,SUPPLY, E&C AND O&M OF 66KV S/Y BAY AT	REV NO: 00
	10MW, KPCL-BELAKAVADI,MANDYA	PAGE : 2 OF 64

1.0 INTRODUCTION

Bharat Heavy Electricals Limited, Electronics Division (BHEL-EDN), Bangalore is setting up a 10 MWp Grid-connected Solar PV Power Plant in Karnataka. Evacuation of 10MW power from PV plant is done at 11kv and subsequently stepped up to 66kv for grid connection. This specification describes requirement of 66kv switchyard bay to be constructed on an EPC basis.

This specification is for inviting tenders from EPC vendors for the following broadly classified activities for 66kv switchyard for evacuating 10MW power:

- a) Design of 66kv switchyard bay.
- b) Supply of materials to site.
- c) Erection and commissioning.
- d) System integration and testing.
- e) Operation and Maintenance (O&M) of the switchyard bay for a period of three years from the date of commissioning.
- f) Obtaining statutory clearances from the authorities such as Electrical Inspectorate. of Govt of Karnataka ,CEIG and any other statutory bodies lies with VENDOR.

1.1 Site location: Shivanasamudram, Belakavadi village, Mandya district, Karnataka.
Distance of PV plant to switchyard is about 200m.

1.2 Pre-Qualification Criteria:

A)Vendor should have completed Design, supply, E&C of at least one switchyard station of voltage rating 66kv and above in the last 2 years .Such system must have been working at switchyard/substation satisfactorily for at least ONE year before the date of opening of tender. Satisfactory performance certificate from the respective customer/end user shall be furnished along with the offer.

B) Average financial turnover of the company for the last three financial years shall be minimum of Rs. 5 crores.

2.0 SCOPE OF WORK

The table below indicates the scope of work for the vendor, as briefly outlined.

The detailed break-up list of activities is provided under clause 3.0 of this specification. The technical specifications are brought out under clauses 4.0 and 5.0. O&M is described under clause 6.0.

#	Scope of work (as briefly outlined)	Qty
1	Design of 66kv switchyard bay.	1 no
2	Supply of 66kV switchyard equipment viz. Lightning arresters, SF6 breaker, CTs, PTs, Isolator as per clause 3.1.4 , ACSR conductors, Gantry, Mounting structures, Marshalling boxes, Insulators, clamps as per clause 3.1.5, C&R panels, Metering panels as per clauses 3.1.6 and 3.1.7	1 set
3	I&C of 66kV switchyard equipment, Control and Relay panels, Metering panel including all necessary mechanical and electrical fittings and interconnections with	1 AU

	PURCHASE SPECIFICATION FOR DESIGN,SUPPLY, E&C AND O&M OF 66KV S/Y BAY AT 10MW, KPCL-BELAKAVADI,MANDYA	PS-439-912
		REV NO: 00
		PAGE : 4 OF 64

	PTs, BMK(Bay Marshalling Kiosk) and Insulators wherever required.		
3.1.6	Supply of indoor type Control and Relay panels for 66kV switchyard and transformer protection.	1 set	Refer clause 5.19
3.1.7	Supply of 66kV Metering panel with ABT compliant tri-vector energy meters with necessary communication support for connecting to SCADA.	1 set	Refer clause 5.20
3.1.8	Supply of earth kits for transformers and metering panels.	As required	Refer clause 4.5 for break-up details.
3.1.9	Tools kit consisting of DMM, tong tester (AC, DC), screw driver set (small, large), spanner set, Allen key set, megger and other essential tools as required for the maintenance operation.	1 set	-
3.1.10	Sign boards, danger boards with inscriptions in both Kannada and English language.	1 set	Refer clause 4.11

Note:

- a) Supplies indicated under the clause 3.1 is the minimum requirement .If required, vendor shall supply additional equipment(s) as per the design, erect, commission, operate and maintain the required equipment's that are necessary for satisfactory and safe operation meeting all the statutory requirements. Specification, type and required quantity of any such additional supplies required shall be furnished by the bidder along with the bid.
- b) SLD indicates minimum requirement and is for tender purpose only. Bidder to submit the design and SLD along with the bid.
- c) Bidders are suggested to visit the site before placing the bid for proper assessment of the requirements.
- d) Any specific technical requirements not mentioned in this specification but required for satisfactory operation shall be brought out in the offer quoting the reference of applicable standards.

3.2 ERECTION AND COMMISSIONING

#	Activity with associated items	Quantity	Clause reference for detailed specifications / BHEL drawings .
3.2.1	Arrangement of temporary electrical power supply at the site (At least 60 KW)	-	Refer clause 4.1
3.2.2	Receipt and unloading of materials arriving at the site from BHEL and other vendors.	-	Refer clause 4.3
3.2.3	Installation of fire-fighting equipment (Fire extinguishers, sand buckets, danger plates etc).	-	Ref Clauses 4.9

	PURCHASE SPECIFICATION FOR DESIGN,SUPPLY, E&C AND O&M OF 66KV S/Y BAY AT 10MW, KPCL-BELAKAVADI,MANDYA	PS-439-912
		REV NO: 00
		PAGE : 5 OF 64

3.2.4	Body earthing of 11kV/66kV Transformer, Lightning arrestors, SF6 breakers, CTs, PTs, Isolators shall be connected to existing earth mat.	1 set	Refer IEEE 80, 2000; Refer clause 5.17;
3.2.5	Installation of BHEL supplied 12.5 MVA, 11kV/66kV transformer with necessary grouting, pedestals, etc.	1 set	-
3.2.6	Installation of gantry with insulators to support and run the ACSR conductors.	As required.	Refer clause 5.10 Quantity indicated is typical. It may vary based on actual design requirements of 66kV switchyard.
3.2.7	Installation of steel mounting structures for mounting of 66kV switchyard equipment.	1 set	Refer sub-clauses of 5.0.
3.2.8	Installation of 66kV switchyard equipment on the steel mounting structures.	1 set	Ref sub-clause within 3.1 for list of equipment.
3.2.9	Laying of ACSR conductors in 66kV switchyard and interconnecting the equipment, using necessary clamps, connectors, etc.	1 set	Refer clause 5.11
3.2.10	Installation of C&R panels in the 66kV switchyard	1 set	Refer clause 5.19
3.2.11	Integration, commissioning and evacuation of power for the entire 10 MW power plant.	-	Refer clause 5.1
3.2.12	Civil works including foundations for mounting of equipments.	As required.	Drawing to be submitted for approval.
3.2.13	Construction of RCC cable trenches in switchyard bay.	As required.	Drawing to be submitted for approval.

3.3 SUPPLEMENTARY WORKS FOR ERECTION

3.3.1	Electricity and Water supply to be arranged by the vendor for construction purpose.	1 set	Refer Clause 4.1 and 4.2
3.3.2	Concrete pedestal with foundation for mounting of 12.5MVA, 66kV/11kV transformer and foundation for mounting of equipments .	1 set	Drawing to be submitted by vendor for BHEL/KPCL's approval.

3.4 INSURANCE

3.4.1	Insurance during Supply, erection and commissioning: (A) For materials and equipment supplied by the vendor, insurance shall be organized by the	1 set	-
-------	--	-------	---

	PURCHASE SPECIFICATION FOR DESIGN,SUPPLY, E&C AND O&M OF 66KV S/Y BAY AT 10MW, KPCL-BELAKAVADI,MANDYA	PS-439-912
		REV NO: 00
		PAGE : 6 OF 64

	vendor, covering the supply, storage and E&C. (B) For materials and equipment supplied by BHEL, Insurance will be organized by BHEL. (C) After commissioning, insurance coverage of entire plant shall be organized by BHEL.		
--	--	--	--

3.5 OPERATION AND MAINTENANCE

3.5.1	Comprehensive O & M of switchyard for three years from date of commissioning.	1 set	Refer clause 6.0; Note: Plant insurance shall be arranged by BHEL during O&M period.
-------	---	-------	--

4.1 ELECTRICAL POWER SUPPLY FOR CONSTRUCTION

- (a) Vendor shall organize necessary electrical power supply required for the construction and other activities that need to be carried out by them at the site (at least 60 KW).
- (b) Monthly charges shall be paid by the vendor against regular power consumption.

4.2 WATER REQUIREMENT FOR CONSTRUCTION

- (a) Vendor shall organize and bear all necessary charges incurred in water supply required for construction .

4.3 MATERIAL RECEIPT AND STORAGE

- (a) Vendor shall receive and store all incoming materials under his scope and BHEL supplied 12.5MVA transformer and accessories in the storage yard located nearby the control room.
- (b) All the materials shall be stored safely and protected against rain, flood, fire etc.
- (c) All documents for incoming materials shall be properly compiled and preserved by the vendor for further handing over to BHEL.
- (d) Safeguarding the materials from theft and pilferage is the responsibility of the vendor.

4.4 CABLES

Specification of cables for control, signaling and power supply is mentioned under clause 5.19.7

4.4.1 Pre-inspection of cables supplied by vendors:

- (a) Pre-inspection of cables will be done by BHEL/KPCL. Hence, the vendor must obtain and submit the detailed inspection plan – routine and type tests for the cables from the manufacturer during detailed engineering
- (b) On completion of inspection, the test certificates must be furnished to BHEL to enable clearance for dispatch to the site.

	PURCHASE SPECIFICATION FOR DESIGN,SUPPLY, E&C AND O&M OF 66KV S/Y BAY AT 10MW, KPCL-BELAKAVADI,MANDYA	PS-439-912
		REV NO: 00
		PAGE : 7 OF 64

4.5 EARTH KITS (GOVERNING STANDARD: IS 3043 – 1987):

4.5.1 Earthing using Pipe Electrode of Ashlok make:

The pipe electrode is filled with conductive compound. The Ashlok model numbers T-19 / T-39 (Zn / Cu coated) of 3000 mm length shall be appropriately selected and employed based on the suitability to the application .Number of electrodes (kits) are shown in Table below.

#	Equipment to the earthed	Kits
(a)	For Transformer body earth, 2 kits each per Transformer, 1x 12.5 MVA	2
(b)	For Transformer Neutrals, 2 kits per Transformer, 1x 12.5 MVA	2
(c)	For C&R panel of 66kV switchyard, body earth	2
(d)	For metering panel, body earth, 2 kits	2

Notes:

1).The earth resistance between the individual earth pit and its associated equipment in 66kv switchyard as indicated above shall be less than 1 Ohm.

2).The quantities indicated above are minimum requirements. However the vendor must supply and install the required quantity of earthing electrodes as per the approved design.

3).All earth pits must be connected to the existing earth mat at 66kv switchyard.

Installation procedure for Ashlok-make pipe electrode:

- Make an 8" or 10" dia bore to a suitable depth in the soil to match the electrode length. From the dug-out soil, remove lumps and stones. If necessary, sieve the soil to remove foreign materials.
- Mix the back filling compound (BFC), as recommended by M/s. Ashlok, with soft soil and throw a handful of the mix into the pit.
- Place the electrode in the kit.
- Throw 2 or 3 Kg of BFC-soil mixture into the pit around the electrode and add a bucket of water.
- Poke the pit with a long pole around the electrode for a few minutes to enable the trapped air to escape. In this manner, continue the earth filling process till the entire electrode stands firmly in the pit. Ensure that the consistency of the BFC is pasty and not watery.
- After finishing the pit work, pour a few buckets of water around the pit.

Instructions on Earthing:

- In the earth pits, masonry enclosure (duly painted and identified with labels) with cast iron cover plate and watering pipe as required as per provisions of IS: 3043 shall be provided.
- For each earth pit, necessary Test Point shall be provided.
- In compliance to Rule 33 and 61 of Indian Electricity Rules, 1956 (as amended up to date), all non-current carrying metal parts shall be earthed with two separate and distinct earth continuity conductors to an efficient earth electrode.
- Earth resistance of the earth pits shall be tested in presence of the representative of BHEL.

	PURCHASE SPECIFICATION FOR DESIGN,SUPPLY, E&C AND O&M OF 66KV S/Y BAY AT 10MW, KPCL-BELAKAVADI,MANDYA	PS-439-912
		REV NO: 00
		PAGE : 8 OF 64

4.6 DC SUPPLY:

DC auxiliary supply 110v is available in the 66kv switchyard. The same shall be used wherever required. Cables to be used for the same is indicated under clause no 5.19.7

4.7 DC FEEDER PANEL :

This shall be wall-mounted with 1 incoming feeder and outgoing feeders as required. Each outgoing feeder shall have an independent MCB control. Both the incoming and outgoing feeders shall have indications. Indicating lamps shall be of LED type. Layout drawing shall be furnished to BHEL along with BOM before taking up for production.

4.8 SCADA CONNECTIVITY FROM 66KV SWITCHYARD C&R PANEL TO CONTROL ROOM OF SOLAR PLANT:

The scope includes

- a) Selection of single mode Optic Fibre Cable (OFC).
- b) Supply of OFC cable of required length .Vendor to access the actual length required.
- c) Laying of OFC cable underground as per the relevant IS standards and such standards employed to be mentioned in the offer.
- d) Establishing SCADA connectivity of switchyard with Solar plant SCADA system and ensuring all data regarding energy generation, status of relays and equipments are made available at Solar plant SCADA system.

Vendor to submit datasheet and test certificates to BHEL before procurement. If required, vendor to arrange for inspection in the presence of BHEL/KPCL's representatives .

Vendor to submit the drawings for trench and routing between switchyard and control room .

4.9 FIRE FIGHTING SYSTEM:

The 66kv switchyard shall be equipped with suitable fire protection and firefighting systems for protection of entire equipment as per CEIG requirements. Vendor shall comply with recommendation of Tariff Advisory Committee to incur minimal premium for insurance. The installation shall meet all applicable statutory requirements, safety regulations in terms of fire protection. The vendor shall provide following portable fire extinguishers, sand buckets and danger notice plates.

(a) Firefighting equipment:

Equipment description	Quantity Nos
Co2 cylinder	As required
Foam type fire extinguishers	As required
Dry chemical power type extinguishers	As required

Note: Quantities shall be decided as per site and CEIG norms. Vendor shall furnish complete details in this regard along with the offer.

	PURCHASE SPECIFICATION FOR DESIGN,SUPPLY, E&C AND O&M OF 66KV S/Y BAY AT 10MW, KPCL-BELAKAVADI,MANDYA	PS-439-912
		REV NO: 00
		PAGE : 9 OF 64

(b) Sand buckets: Quantity: As required

The bucket should be wall-mounted made from at least 24 SWG sheet with * bracket fixing on wall conforming to IS 2546.

Note: Quantities shall be decided as per site and CEIG norms. Vendor shall furnish complete details in this regard along with the offer.

(c) Danger notice plates:

The danger notice plates shall be provided wherever necessary. Suitable size of the notice plate shall be provided as per statutory requirement. These shall be made of mild steel sheet of at least 2 mm thick, with vitreous enameled white on both sides and with inscription in signal red colors on front side as required. The inscriptions shall be in Kannada and English language.

(d) Fire protection for 12.5MVA transformer:

(i) Soak pit and Drain pit: The transformer foundation shall be surrounded by a suitable soak pit. This soak pit shall be filled with coarse crushed stones. In case the soak pit is unable to contain the entire volume of the oil, provision shall be made to let out the excess oil through hume pipes from the bottom of the pit to burnt oil tank. Control cables emanating from the transformer shall be led through the soak pit through hume RCC pipes. The construction must be as per CBIP norms.

(ii) Barrier between transformers: One firewall to be constructed to separate the transformer from the adjacent one. The barrier shall extend at least 300mm above highest transformer bushing and pressure relief vent and lengthwise 600mm beyond the transformer including any radiator and tap changer enclosure.

(iii) Fire hydrant and sprinkler system: As per CBIP norms.

4.10 GANG OPERATED AIR BREAK SWITCH (GOS) WITH EARTH SWITCH:

4.10.1 Vendor shall supply and install outdoor type Gang Operated Air Break Switches (GOS) mounted on double-pole structure just before the primary of 12.5MVA, 11/66kV transformer in 66kV switchyard. The concrete poles shall be of 9 meter height with necessary civil works. The double pole structure shall be as per relevant IS and CEIG recommendations and the relevant IS standards to be mentioned by the vendor in the offer.

4.10.2 The operating mechanism shall be suitable for manual operation from ground level by one person with ease and shall be so designed that all the three phases open or close simultaneously. The operating rod shall be of GI pipe of minimum 30 mm diameter and of about 6000 mm length. The operating handle (GI) shall be of suitable length (about 1600 mm) so as to provide ease of leverage to the operating person. Suitable padlocking or other approved locking arrangement shall be provided for locking the operating handle both in the ON and OFF positions.

4.10.3 All ferrous parts (except springs) shall be hot-dip galvanized. Galvanization thickness shall be as per IS:4759 standards and galvanization thickness shall be mentioned in the offer.

4.10.4 Termination kits (11 kV) required for termination of the two runs each of 3-core x 400 sq mm aluminum XLPE cables for incoming and outgoing cables shall be supplied.

	PURCHASE SPECIFICATION FOR DESIGN,SUPPLY, E&C AND O&M OF 66KV S/Y BAY AT 10MW, KPCL-BELAKAVADI,MANDYA	PS-439-912
		REV NO: 00
		PAGE : 10 OF 64

4.10.5 GOS shall include Earth switch.

4.10.6 Drop out fuse to be provided along with the GOS. Fuse rating shall be approved by BHEL during detailed engineering.

4.10.7 The air break switches shall be robust in construction, easy in operation and shall be protected against over travel or stalling that might adversely affect any of its parts. The specification of air break switch employed for each of the three phases is as follows:

1	Operating / Rated voltage	11 kV / 12 kV
2	Impulse withstand voltage	75 kV peak
3	Power freq withstand voltage (1 minute)	28 kV rms
4	Continuous current	800A
5	Short-time current rating	31.5 kA
6	Type of switch	Triple pole, one or two insulators per pole, Horizontal double break type and tandem type.
7	Insulators	Porcelain insulators conforming to IS 2544 / IEC 273. Made up of homogeneous material, with uniform glazing, free from cavities and other flaws, with high quality smooth finish. Fixed electrical contacts are supported by the insulators.
8	Mounting base	The three poles shall be mounted on a rigid base of MS channel of minimum size of 75x 40 x6 mm (hot dip galvanized), provided with suitable holes, clamps and bolts to enable firm mounting.
9	Electrical contacts	All current carrying parts shall be made of electrolytic copper (silver plated). The fixed contacts shall be of spring-loaded pressure type so as to ensure firm contact and proper alignment. (The springs shall not carry any current). Arcing contacts shall be provided with spring assisted operation.
10	Mounting requirement	Horizontal
11	Earthing terminals	Two earthing terminals, with adequate size to carry full short circuit current, shall be provided on the frame of each pole.
12	Standard	IS 9921 part 1 to 4 / IEC 62271-102.

NOTE: The above details are tentative. Vendor shall submit complete details to BHEL for approval during detailed engineering.

	PURCHASE SPECIFICATION FOR	PS-439-912
	DESIGN,SUPPLY, E&C AND O&M OF 66KV S/Y BAY AT	REV NO: 00
	10MW, KPCL-BELAKAVADI,MANDYA	PAGE : 11 OF 64

4.11 SIGN BOARDS

The sign boards shall contain brief description of the power plant. The sign board will be made of steel plate of not less than 3 mm. Aluminum strip of 2 mm thickness, 18 mm width and length equal to the length of sign board shall be provided with the board for clamping the board on to the RC poles. Additionally signboards as "DANGER", "66 KV SWITCHYARD", etc shall be provided at appropriate places. The inscriptions shall be in both Kannada and English languages.

4.12 9 KV ZINC OXIDE LIGHTNING ARRESTERS

Vendor shall provide 3 nos of 9kv LA with the following specifications

- (1) Arrestor rating: 9kV, 10kA, Class-3 with IB
- (2) Type: Metal oxide Gapless lightning arrester
- (3) Standard: IS 3070 (part-3) 1993 & IEC 60099-4 of 2004
- (4) Minimum acceptance tests that shall be witnessed by BHEL
 - (a) Power frequency reference voltage test at 3mA
 - (b) Partial discharge test at MCOV x 1.05
 - (c) Lightning impulse residual voltage test at 100% NDC
 - (d) Functional tests on surge monitor
 - (e) Galvanization test on exposed metal parts
 - Uniformity, mass, thickness of Zn coating
 - (f) Visual examination and dimensional verification
- (5) Vendor shall provide inspection call to BHEL. Quality assurance plan shall be submitted prior to inspection call.
- (6) These lightning arrestors / surge suppressors (3 Nos) shall be mounted on structures with suitable mounting arrangement.

NOTE: The above details are tentative. Vendor shall submit complete details to BHEL for approval during detailed engineering.

4.13 CABLE TRENCHES:

Covered RCC Cable trenches in switchyard shall be constructed for laying of power, signaling and control cables. IS standards employed shall be mentioned in the offer.

5.0 TECHNICAL SPECIFICATION - 66kV SWITCHYARD EQUIPMENT:

(Nominal voltage: 66kV, Rated voltage: 72.5kV)

5.1 SCOPE:

The scope under this specification covers the following:

- i) Measurement of resistivity of the soil and laying of additional mat if required, to bring down the resistance to less than 0.5 Ohms.
- ii) Preparation of fabrication drawings of the switchyard structures.
- iii) Supply, erection, commissioning of following switchyard equipment's and other materials.
 - a) 1 No. 72.5 kV SF6 breakers triple pole circuit breaker, along with associated control cubicles and support structures & spares.
 - b) 2 No. 72.5 kV isolator, with earth switch, motor operated mechanism and support

	PURCHASE SPECIFICATION FOR	PS-439-912
	DESIGN,SUPPLY, E&C AND O&M OF 66KV S/Y BAY AT	REV NO: 00
	10MW, KPCL-BELAKAVADI,MANDYA	PAGE : 12 OF 64

- structures.
- c) 3 Nos. 72.5 kV single phase, oil immersed current transformers along with galvanized steel support structures (for metering and protection)
 - d) 3 Nos. 72.5 kV single phase potential transformers along with galvanized steel support structures (for metering and protection)
 - e) 6 Nos. 60 KV, single-phase, zinc oxide lightning arrestors with surge counters along with galvanized steel support structures.
 - f) ACSR conductor for inter equipment connection and bus connection.
 - g) Required quantity of support structures for switchyard equipment.
 - h) Required quantity of post and Disc insulators including suspension hard wares and stringing hardware.
 - i) Phase identification plates, Danger boards as per the statutory requirement, paint for touch up painting of equipment and its accessories.
 - j) Required quantity of earthing materials for the switchyard.
 - k) Any other materials those are essential for completion of the switchyard works.

Note:

- 1) 11/66 kV transformer (12.5MVA) is under BHEL scope of supply.
- 2) Obtaining statutory clearances from the authorities such as Electrical Inspectorate of Govt of Karnataka, CEIG and any other statutory bodies lies with VENDOR.

5.2 DRAWING REFERENCE

SLD ref **3-679-05-00737** indicates minimum requirement and is for tender purpose only. Every bidder has to submit the design and SLD along with the bid.

5.3 DESIGN FEATURES FOR 66 KV SWITCHYARD

The following are the main features, parameters of the 66kV switchyard:

- | | | | |
|------|-------------------------|---|----------------------|
| i) | Nominal system voltage | : | 66 kV |
| ii) | Highest system voltage | : | 72.5 kV |
| iii) | System neutral earthing | : | Effectively earthed. |

The following parameters shall be considered for spacing of the equipment, conductors, etc., for the design purposes. The values of clearances to be furnished by VENDOR, complying with the necessary Electrical / safety considerations..

<u>Clearances in air:</u>	<u>Vendor to furnish</u>
i) Between phases	:
ii) Phase to earth	:
iii) Section clearance to the live parts	:
iv) Ground clearance to the live parts	:

Voltage withstand levels:

- | | | | |
|------|---------------------------------|---|--|
| i) | One minute power frequency | : | |
| ii) | 1.2/50 micro second impulse | : | |
| iii) | Creepage distance for equipment | : | |
| iv) | No. of phases | : | |

	PURCHASE SPECIFICATION FOR	PS-439-912
	DESIGN,SUPPLY, E&C AND O&M OF 66KV S/Y BAY AT	REV NO: 00
	10MW, KPCL-BELAKAVADI,MANDYA	PAGE : 13 OF 64

- v) Frequency :
- vi) Short circuit current :
- vii) Co-efficient of seismic
 - a) Acceleration in horizontal :
 - b) Acceleration in vertical :

5.4 66 KV CIRCUIT BREAKER:

The Circuit breaker shall be of sulphur hexafluoride SF6 type and comply with the requirements of latest issue of IEC: 62271-100 (latest edition) and any other equivalent International Standards. The circuit breaker shall be suitable for outdoor operation.

5.4.1 GENERAL

- i) The circuit breaker shall be of modular construction with all components manufactured to assure the maximum inter-changeability of standard basic elements. All parts of the breaker unit shall be mechanically designed to withstand all electrical, mechanical and other stresses which may be experienced in the operation of the unit including those under short circuit conditions. Suitable lock nuts and locking plates shall be provided for bolts and nuts inside the mechanism housing to avoid loosening of the bolts & nuts due to vibrations.
- ii) The breaker shall comprise of three identical single pole units, ganged together mechanically, complete in all respects with the associated accessories including fittings.
- iii) The design and construction of the equipment valves, couplings, connections shall be such that leakage of any SF6 gas shall be limited to a minimum. Similarly, valves, couplings and pipe work shall be so arranged that accidental loss of gas to the atmosphere shall also be limited to a minimum.
- iv) The circuit breakers shall be provided with two trip coils for the system.
- v) Weather proof and corrosion proof rating plates showing all the details as per clause 13 of IS: 2516 (Part III/Sec2) of latest edition shall be provided on all circuit breakers and its operating devices.
- vi) The circuit breakers shall be reasonably quiet in operation.
- vii) All fittings and accessories which may not have been specifically mentioned, but which are necessary and essential for the efficient working, shall be deemed to be included in the contract.
- viii) DUTY REQUIREMENTS
 - a) The circuit breakers shall be totally re-strike free under all duty conditions and shall be capable of performing their duties.
 - b) The circuit breakers shall be so constructed that they would fail safe in the event of loss of SF6 gas pressure below a certain level.
 - c) The circuit breaker shall meet the duty requirements for any type of fault or fault location.

	PURCHASE SPECIFICATION FOR	PS-439-912
	DESIGN,SUPPLY, E&C AND O&M OF 66KV S/Y BAY AT	REV NO: 00
	10MW, KPCL-BELAKAVADI,MANDYA	PAGE : 14 OF 64

- d) The circuit breaker shall be capable of carrying, continuously under site conditions, the rated rms value of the current without deterioration at its rated frequency with the temperature rise of the various parts not exceeding the values specified in IEC-62271-100 latest edition.
- e) The circuit breaker shall be capable of rapid and smooth interruption of current, completely suppressing all undesirable phenomena under all the conditions such as severe and persistent short circuit, interruption of steady and transient magnetising current of transformers, small inductive currents, fault current under phase opposition condition etc.
- f) The circuit breaker shall be suitable for three phase and single phase auto-re-closing duty of O-0.3 Sec –CO-3 min-CO where dead time is 300 m sec.
- g) The circuit breaker shall be of single break and the breaker shall satisfactorily withstand the high stresses imposed on them during fault clearing, load rejection and re-energisation of lines with trapped charges. The breaker contacts (Main & arcing) shall be of high erosion resistant and the erosion of contacts shall be limited to a minimum.

5.4.2 CONSTRUCTIONAL FEATURES

- i) The features and constructional details of circuit breakers shall be in accordance with requirements stated here under.

ii) CONTACTS

- a) All making and breaking contacts shall be sealed and free from atmospheric effects. The contacts shall be permanently under the pressure of SF6 gas. The gap between open contacts shall be such that it can withstand the rated dielectric stresses at zero gauge pressure of SF6 gas due to its leakage.
- b) Main contacts shall be the first to open and the last to close so that there will be little contact burning and wear.
- c) Arcing contacts shall be the first to close and the last to open and shall be easily accessible for inspection and replacement. If there are no separately mounted arcing contacts, the main contacts shall be accessible for inspection and replacement.
- d) Main contacts shall have ample area and contact pressure for carrying the rated current and the short time rated current of the breaker without excessive temperature rise which may cause pitting or welding.
- e) Tips of arcing and main contacts shall be silver plated or have a tungsten alloy tipping.

iii) INSULATING SUPPORTS AND HOUSING

Porcelain used in the manufacture of insulating supports / housing shall be homogenous, free from cavities and other flaws or imperfections that might affect the mechanical or dielectric quality and shall be thoroughly vitrified, tough and impervious to moisture. Glazing of the porcelain shall be of uniform brown colour,

	PURCHASE SPECIFICATION FOR DESIGN, SUPPLY, E&C AND O&M OF 66KV S/Y BAY AT 10MW, KPCL-BELAKAVADI, MANDYA	PS-439-912
		REV NO: 00
		PAGE : 15 OF 64

free from blisters, burns and similar other defects. Porcelain supports / housings shall be designed to have ample insulation, mechanical strength and rigidity for the conditions under which these will be used. All insulator housings of identical ratings shall be interchangeable. The puncture strength shall be greater than the dry flashover value. When operating at normal rated voltage, there shall be no electric discharge between the conductor and the porcelain parts which may cause corrosion or injury to conductors / insulators or supports by the formation of substances produced by chemical action. The insulating supports / housings shall be free from radio disturbances when operating at rated voltage and shall also be free from external/internal corona. The insulating supports / housing shall satisfactorily withstand the insulation level specified for circuit breakers.

iv) SULPHUR HEXAFLUORIDE GAS (SF6 GAS)

- a) SF6 gas shall comply with IEC: 60376 and be suitable in all respects for use in the switch gear under the operating conditions. The necessary test certificates shall be furnished during inspection of breakers.
- b) The high pressure cylinders in which the SF6 gas is shipped and stored at site shall comply with requirements of the following standards and regulations:
 - IS: 4379 - Identification of the contents of Industrial Gas Cylinders.
 - IS: 7311 - Seamless high carbon steel cylinders for permanent and high pressure liquifiable gases.
- c) Absorbent shall be provided in the interrupter unit of each phase (where SF6 gas is used) to absorb any traces of moisture. These shall be permanent facilities.
- d) The precise procedure to be adopted by maintenance personnel for handling equipment, who are exposed to the products of arcing in SF6 gas, so as to ensure that they are not affected by possible irritants of the skin and respiratory system.

v) SUPPORT STRUCTURE

The contractor shall supply the SF6 breaker along with support structures of self-supporting type and foundation bolts required. Support structure and foundation bolts shall be supplied along with each breaker.

5.4.3 OPERATING MECHANISM

i) GENERAL

- a) Circuit breaker shall be spring operated for both opening and closing operations. The mechanism shall be strong, positive, quick in action and shall be removable without disturbing the other parts of the circuit breaker. The mechanism shall operate simultaneously without requiring any critical adjustment.
- b) The operating mechanism shall be suitable for high speed re-closing of the breaker over a wide range of parameters. It shall be anti-pumping and trip



**PURCHASE SPECIFICATION FOR
DESIGN, SUPPLY, E&C AND O&M OF 66KV S/Y BAY AT
10MW, KPCL-BELAKAVADI, MANDYA**

PS-439-912

REV NO: 00

PAGE : 16 OF
64

free. In case of failure of a pole to close properly, all the three poles should trip.

- c) A mechanical indicator along with operation counter shall be provided in addition to facilities for remote electrical indication to show open and close position of breaker. It shall be located in a position where it will be visible to a man standing on the ground with the mechanism housing closed and easily accessible from the ground for the O&M personnel to operate and maintain locally.
- d) The control circuit shall be designed to operate on 110 V DC +/- 10%. Closing coil and trip coil shall operate correctly at all values of voltage between 85% to 110% and 70% to 110% of the rated voltage respectively. Arrangements shall be made for providing two sources of control supply to the 2 trip coils.
- e) Working parts of the mechanism shall be of corrosion resisting material. Bearings which require grease shall be equipped with pressure type grease fittings. Bearing pins, bolts, nuts and other parts shall be adequately locked by split pins, lock nuts, plates wherever required to prevent loosening or changing adjustment with repeated operation of the breaker.
- f) Operating mechanism shall normally be operated by remote electrical control. Electrical tripping shall be performed by shunt trip coils. Provisions shall be made for local electrical control. 'Local/remote' selector switch and close and trip push buttons shall be provided in the breaker control cabinet on a hinged panel with position locked with bolt and nuts to provide access to the rear of panel for maintenance purpose. The relay trip should act independent of the position of local/remote selector switch. In the event of failure of auxiliary supply, manual emergency trip lever shall also be provided to trip the circuit breaker.
- g) The circuit breaker shall be gang operated and mechanically linked for tripping and closing. The Group operating mechanism housing along with all pressure switches, gauges, indication and other equipments and all the necessary controls are housed in a marshalling box, which is common for all three phases. The operating mechanism housing / marshalling box shall be of outdoor type and weather proof. The box shall be fabricated out of not less than 12 SWG thick mild steel cold rolled sheet of tested quality complying with the latest edition / amendment of IS 513/1973. The operating mechanism housing / marshalling box shall have hinged door, which could be easily closed without applying excessive pressure on the doors. The door hinges shall operate at ease and strong enough to withstand the self-weight of the door and to keep the door properly aligned. The complete box shall be fabricated in such a way that when closed it shall be perfectly water tight, dust proof and vermin proof and conform to IP55 as per IS:2147. All Marshalling box shall be provided with necessary fixtures for fixing the cable entry and exit pipes with check nuts on all the sides of the marshalling box. Thermostatically controlled space heaters, a light point with a door switch shall be provided and MCBs shall be used for protection of supply to space heaters. The mounting height of the box shall be easily assessable for a person standing on the ground for operation and maintenance.

	PURCHASE SPECIFICATION FOR DESIGN,SUPPLY, E&C AND O&M OF 66KV S/Y BAY AT 10MW, KPCL-BELAKAVADI,MANDYA	PS-439-912
		REV NO: 00
		PAGE : 17 OF 64

- h) Provisions shall be made on breakers for attaching an operation analyser to perform speed tests after installation at site to record contact travel against time and measure opening time.
 - i) The circuit breaker shall be provided with pole position discrepancy detector with an associated timer of 0.1 Sec. to 2 minutes adjustable time delay.
 - j) The contractor shall furnish along with Test Certificates, curves supported by test data indicating opening time under close-open operation with combined variation of trip coil voltage and operating pressure.
- ii) SPRING OPERATING MECHANISM FOR BOTH CLOSING AND TRIPPING**
- a) Closing and tripping operations shall be by spring charging. When the closing signal energises the Closing coil, the trigger shall release and the charged closing spring shall close the Breaker and also recharge the opening spring. When opening signal is given, the energy accumulated in the opening spring shall be released and cause the main contacts of the breaker to separate.
 - b) The spring operating mechanism shall have adequate energy stored in the operating springs to close/open and latch the Circuit Breaker against the rated making current and also to provide required energy for both closing and tripping mechanism.
 - c) The spring charging motor shall not take more than 10 seconds for fully charging the closing springs and provision shall be made for automatic charging of the closing springs as soon as they are discharged in a closing operation. For this, the mechanism shall be such that the charging of the springs by the motor does not interfere with the operation of the Breaker.
 - d) The motor shall be adequately rated to carry out a minimum of 5 close and open operations continuously. Also provision shall be made to protect the motor against over loads. The motor shall be rated for 240 V AC.
 - e) Mechanical inter locks shall be provided in the operating mechanism to prevent discharging of the closing springs when the Breaker is already in the closed position. Provision shall also be made to prevent a closing operation to be carried out with the spring partially charged.
 - f) Facility shall be provided for manual charging of the closing springs and it shall be possible to operate the same standing on the ground.
 - g) The pole units shall be filled with SF6 gas at atmospheric pressure of 0.5-1 kg/sq. cm before despatch and sufficient SF6 gas shall be supplied with the breaker to fill all the circuit breakers installed to the required pressure plus an additional 20% of the quantity to compensate for losses. Vendor shall arrange for the necessary tools and tackles such as adaptor for lock out test, tools for refilling of SF6 gas at site etc.

5.4.4 RATING PLATE

Weather proof and corrosion proof rating plates showing year of manufacture and other values as per IS: 2516 shall be provided on all circuit breakers and its operating devices.

	PURCHASE SPECIFICATION FOR	PS-439-912
	DESIGN,SUPPLY, E&C AND O&M OF 66KV S/Y BAY AT	REV NO: 00
	10MW, KPCL-BELAKAVADI,MANDYA	PAGE : 18 OF 64

5.4.5 TERMINAL CONNECTORS AND EARTHING TERMINALS

The terminal connectors shall be either bi-metallic or aluminium as the case may be and shall be suitable for ACSR conductor for both vertical and horizontal take off. Suitable terminals for earthing connectors for earthing connections shall also be provided for the structures, operating cubicles and marshalling boxes. The grounding conductors shall be 50 x 6 mm steel flat.

5.4.6 TERMINAL BLOCKS

Terminal blocks shall be 1100 V grade and of current capacity 10 Amps with insulated barriers and stud type terminals, spring washers, nut and lock nuts and identification strips. All wiring terminations shall be with suitable tinned copper crimped lugs. All wiring shall be carried out with flameproof insulated wires made up of tinned or annealed copper conductor.

5.4.7 AUXILIARY SWITCHES

Positively driven (in both directions) auxiliary switches (contacts) each of the normally open and normally closed types and a continuous current carrying capacity of at least 10 Amps shall be provided on each circuit breaker for use in the remote indication for control of the circuit breaker and for providing safety interlocking.

They shall be capable of breaking at least 2 Amps at 110V DC with circuit time constant of not less than 20 milli seconds. If installed on the frame of breakers, it shall be suitably protected against accidental arcing from the main circuit. The insulating materials of the switches and terminals shall be of ceramic or other non-tracking and non-hygroscopic materials.

Special contacts for use with trip coils and single shot re-closing operation which permit relative adjustment with respect to the travel of the circuit breaker shall also be provided wherever required. Required number of auxiliary switches shall be provided.

5.4.8 INTERLOCKS

Necessary interlocks to prevent the closing of the breaker (manual and remote) under low gas/air pressure and devices for initiating alarm for low gas pressure shall be provided. Provision shall also be made to enable electrical interlocking with the opening or closing of the isolator when the breaker is closed with the spare auxiliary contacts wired up to the terminal block.

5.4.9 FITTINGS AND ACCESSORIES

The vendor shall furnish the following fittings and accessories as an integral part of the equipment:

- a) Operating Mechanism Housing
- b) Pad locks and duplicate keys



**PURCHASE SPECIFICATION FOR
DESIGN, SUPPLY, E&C AND O&M OF 66KV S/Y BAY AT
10MW, KPCL-BELAKAVADI, MANDYA**

PS-439-912

REV NO: 00

PAGE : 19 OF
64

- c) Local/remote change over switch
- d) Operation counter
- e) Terminal board with minimum 10% spare terminals
- f) MCB/MCCB to cut off control power supply, wherever required.
- g) Two earthing terminals
- h) Auxiliary relays required for satisfactory operation
- i) Breaker local control switch for opening and closing of breaker Terminal connectors
- j) 3 pin 15A socket outlet
- k) Earthing pads
- l) Foundation bolts
- m) Galvanised steel structures/Steel frames for mounting of the breakers.
- n) Necessary cables from respective Control cubicles to marshalling box/Central control cubicle of the Breaker.
- o) Apart from the above, one set of SF6 Gas regulator along with hose for Gas filling/evacuating shall be supplied.

5.4.10 TESTS

- i) The circuit breaker shall comply with the type test and the routine tests prescribed in IEC-62271-100. The routine acceptance tests shall be carried out on each breaker before despatch.
- ii) Report of all type tests as stipulated in IEC and the line charging current and transformer charging current, interrupting tests shall be furnished if already carried out within the last 5 years as on date of bidding. Otherwise, the type tests shall be carried out at no additional cost to BHEL.
- iii) No equipment shall be despatched without prior approval of the test certificate and despatch instructions are conveyed by the purchaser.
- iv) Routine acceptance tests shall be carried out on each breaker in the presence of BHEL representative if so desired. Test certificates in six sets shall be furnished to BHEL for approval. Also BHEL/KPCL representative shall have access to the manufacturer's works for the purpose of inspecting the manufacture of the equipment.

5.4.11 SITE TESTS ON CONTROL AND AUXILIARY CIRCUITS

The following site tests shall be carried out at the time of commissioning of the breakers:

- i) Voltage tests on control and auxiliary circuits
- ii) Measurement of resistance in the main circuit.
- iii) Mechanical operating tests.
- iv) Speed curves shall be obtained with the help of a suitable operation analyser to determine breaker contact movement during opening, closing, auto-re closing and trip free operation under normal as well as limiting operating conditions (control voltage, gas pressures etc). The tests shall show the speed of contacts at various stages of operation, travel of contacts, opening time, closing time,



**PURCHASE SPECIFICATION FOR
DESIGN,SUPPLY, E&C AND O&M OF 66KV S/Y BAY AT
10MW, KPCL-BELAKAVADI,MANDYA**

PS-439-912

REV NO: 00

PAGE : 20 OF
64

shortest time between separation and meeting of contacts at break-make operation etc.

- v) Tests to measure the difference in the instance of closing/opening of contacts between poles.

5.4.12 TEST ON SF6 GAS

The test certificates as obtained from the SF6 gas supplier shall be furnished during inspection of the circuit breakers.

5.4.13 PAINTING

The operating housing mechanism, Control cubicle shall be painted both inside and outside as per standard "seven tank" method with one coat of French grey paint in the inside and light grey paint to shade 635 of IS:5 on the outside surfaces as per relevant standards.

5.4.14 GUARANTEED TECHNICAL PARTICULARS

The SF6 gas circuit breaker supplied shall comply with the Guaranteed technical particulars as indicated below.

1	Number of poles	3
2	Class	Out Door Type
3	Nominal System Voltage	66 kV
4	Rated Voltage	72.5 kV
5	Rated Insulation Level	350 kV (peak)
6	Rated Frequency	50 Hz
7	Rated normal current	1250Amps.
9	Rated Cable Charging breaking current	Vendor to furnish the details.
10	Rated S.C. breaking current	31.5 kA
11	First pole to clear factor	Vendor to furnish the details.
12	S.C. making current	Vendor to furnish the details.
13	Rated Operating Sequence	O-0.3sec-CO-3min.-CO
14	Duration of short circuit	3 sec.
15	Rated out of phase breaking current	Vendor to furnish the details.
16	Automatic rapid re closing	3 Ph.
17	Total break time for any current up to the rated breaking current with limiting conditions of operating coil voltage, operating & quenching media pressures.	< 60 ms
18	No. of auxiliary contacts for purchasers use	10 NO & 10 NC on each pole
19	System neutral earthing	Effectively earthed
20	Closing time (max.)	<150 ms
	Opening time (max.)	<50 ms



**PURCHASE SPECIFICATION FOR
DESIGN,SUPPLY, E&C AND O&M OF 66KV S/Y BAY AT
10MW, KPCL-BELAKAVADI,MANDYA**

PS-439-912

REV NO: 00

PAGE : 21 OF
64

21	Trip & Closing coil Voltage	110 V+/-10% DC
22	Arcing time	<=25 micro sec.
23	Creepage distance (min.)	Vendor to furnish the details.
24	1.2/50 micro sec. lightning impulse withstand voltage.	
	i) to earth	Vendor to furnish the details.
	ii) across the open circuit voltage applied to one terminal	Vendor to furnish the details.
25	Power frequency withstand voltage	
	i) to earth	Vendor to furnish the details.
	ii) across terminals of open circuit breaker	Vendor to furnish the details.
26	Type of operation	Spring
27	Rated values of transient recovery voltage for terminal faults	As per IEC:62271-100
28	Rated values of transient recovery voltage for short line faults	As per IEC:62271 - 100
29	Rated characteristics for out of phase breaking current	As per IEC:62271 - 100
30	Small inductive current interrupting capacity	Vendor to furnish the details.
31	Rated terminal load	Vendor to furnish the details.
32	Difference in the instants of closing/opening of contacts at rated voltage and rated operating and quenching media pressure.	
	i) within a pole	Vendor to furnish the details.
	ii) between poles	Vendor to furnish the details.
33	Insulation level of bushings	
	i) 1 min. p.f. withstand voltage	Vendor to furnish the details.
	ii) 1.2 / 50 microsecond lightning impulse with standing voltage	Vendor to furnish the details.
34	Partial discharge level	As per IEC:62271 - 100
35	Controls of switching surges	Vendor to furnish the details.
36	Noise level of equipment	Vendor to furnish the details.

	PURCHASE SPECIFICATION FOR DESIGN,SUPPLY, E&C AND O&M OF 66KV S/Y BAY AT 10MW, KPCL-BELAKAVADI,MANDYA	PS-439-912
		REV NO: 00
		PAGE : 22 OF 64

37	Auxiliary power supply	415V+/-10%,3ph,50Hz+/-5%,AC
		240V+/-10%,1ph,50Hz+/-5%,AC
		110V +/-10% DC

NOTE: The above details are tentative. Vendor shall submit complete details to BHEL for approval during detailed engineering.

5.5 66 KV ISOLATORS WITH EARTH SWITCH:

5.5.1 TYPE AND RATING

Isolating switches are used to isolate the equipment. The Isolators shall be suitable for outdoor operation.

5.5.2 STANDARDS

The isolator switches shall comply in all respects with IS:9921 or IEC publication No.129 latest edition.

5.5.3 CONSTRUCTIONAL FEATURES OF HORIZONTAL DOUBLE BREAK TYPE

- i) The Horizontal double break type, three phase isolators shall be centre pole rotating, gang operated through **motor operated mechanism**. The design of the isolators shall be such that the switch can be changed to right or left hand operations. The live parts shall be designed to eliminate sharp points, and other surfaces likely to produce corona and adequate shield shall be provided. Live parts shall be manufactured from non rusting, non corroding metal. Current carrying parts shall be of hard drawn electrolytic grade copper. Bolts, screws and pins shall be provided with lockwashers, keys or other equipment locking facilities and if used on current carrying parts, shall be made of copper silicon alloy or equivalent material. The isolator shall not require lubrication of any part at frequent intervals.
- ii) The isolators shall be suitable for being mounted in upright positions (with blades moving in the horizontal plane) on the steel support structures and also suitable for mounting on the high type structures in the outdoor yard.
- iii) The double break isolator shall consist of three identical pole units. Isolators are required to be double break, three posts per phase, triple pole, single throw, rotating center post through double tandem pipe, silver plated contacts, with horizontally operating blade and insulator posts arranged vertically.
- iv) The isolators shall have rotating blades feature and pressure relieving contacts with turn and twist mechanism. The isolators shall be **motor operated with emergency manual operating mechanism**. The manual operating mechanisms shall be of robust construction, conveniently located for operation and easily operatable by a single person. The length of the operating rod shall be such that the height of the manual operating handle above the ground is 1500 mm. The isolator shall be so constructed that the switch blades will not fall to the closed position, if the operating shaft gets disconnected.
- v) The moving blades of double break isolator shall be HDEC (hard drawn electrolytic copper) tube of suitable thickness or one solid copper piece with contact surface silver plated to carry continuous / short time current. Construction shall be so designed that no part of the blade can move relative to the other



**PURCHASE SPECIFICATION FOR
DESIGN,SUPPLY, E&C AND O&M OF 66KV S/Y BAY AT
10MW, KPCL-BELAKAVADI,MANDYA**

PS-439-912

REV NO: 00

PAGE : 23 OF
64

parts. The thickness and section of the blade shall be such that it retains its form and straightness under all conditions of operation including the flow of system fault current for the specified period. It shall also be capable of withstanding all torsional and bending stress due to operation of the isolators. Wherever necessary, the blades shall be counter balanced by weights or springs. Fixed guides shall be provided so that proper seating of contacts will be achieved while closing even when a blade is out of alignment by 3 cm or less. Further, the main blade shall pass through the main actuator assembly without any joints so that there is no necessity of shunting by flexible copper conductors.

- vi) The design and construction shall be such as to provide positive control of blades in all positions with minimum mechanical stress on insulators. Fixed guides shall be provided so that proper seating of contacts shall be obtained.

5.5.4 CLEARANCES

Clearances between live parts and grounded structures shall not be less than those specified in the latest edition of IS(Standard followed to be indicated in the offer). Length of break in full open position shall be such that there is absolutely no possibility of arc over from the live parts to the de-energised parts on which any maintenance works may have to be done. The speed of opening or closing the switch shall be designed to ensure that the arcing during the operation is reduced to the minimum. The necessary arcing contacts shall be provided on the moving blades.

5.5.5 ISOLATOR INSULATION

- i) Insulation to ground, insulation between open contacts and the insulation between phases of the completely assembled isolator shall be capable of withstanding the di-electric test voltages specified in the data sheets enclosed. Insulation between open contacts of a pole shall be atleast be 15% more than the insulation between live parts of a pole to ground so that if any flash over occurs when isolator is open, it shall be to the ground.
- ii) The post type insulators, which should be solid core of multiple stack, shall conform to IS:2544 or other internationally recognised standards. The insulators selected shall be for use in heavily polluted atmosphere and shall be specifically suited to meet the particular requirements of ultimate torsional strength and cantilever loads, which they will be called upon.
- iii) The porcelain shall be homogenous and free from all cavities and flaws. Design of the insulators shall ensure ample insulation, mechanical strength and rigidity for satisfactory operation under site conditions. The design, shall also ensure that the losses caused by capacitive currents or conduction through dielectric are minimum and that the leakage due to moist and dirty insulators surface is least.
- iv) All metal caps and supports shall be connected to the porcelain where as the blades and contact blocks shall be bolted to the metal parts of insulator thus making the replacement of damaged insulator easy.

	PURCHASE SPECIFICATION FOR	PS-439-912
	DESIGN,SUPPLY, E&C AND O&M OF 66KV S/Y BAY AT	REV NO: 00
	10MW, KPCL-BELAKAVADI,MANDYA	PAGE : 24 OF 64

5.5.6

OPERATING MECHANISM

- i. The design of operating mechanism shall be such that minimum of energy is required for operation and one man shall be able to operate the switch without undue effort. The operating mechanism and its controls shall be so designed that under no circumstances the switch blade travel is interrupted before it reaches the fully close or open position
- ii. **Each isolator shall be remote controlled from the control room. Provision shall also be made for local electrical control.** The operating mechanism shall also be equipped with local manual operating device intended for emergency operation in case motor operating mechanism fails. It shall be possible to padlock the manual operating handle both in open and closing positions of the isolators. Additional electro-magnetic type interlock shall be provided on the manual operating handle and control cubicle for motor so as to prevent the operation of the isolator manually and locally when the corresponding circuit breaker is 'ON'. Isolator inclusive of their operating mechanism should be such that they cannot come out of their open and close positions by gravity, wind pressure, vibration and shocks etc.
- iii. The motor operating mechanism shall actuate 3 pole group operated double break isolators. The operating mechanism shall be capable of providing a quick, simple and effective operation. The motor mechanism shall be connected to the torsional control of isolator through a suitable coupling assembly. Suitable means to limit over travel shall be provided. Motor shall conform to IS: 325 and shall develop a starting torque equal to atleast 2.5 times the torque required to operate the isolator. The local/remote selector switch and set of open/ close push button shall be provided on the control cabinet of the isolator to permit local and remote operation.
- iv. Two Nos. of earthing terminals shall be provided on the motor operating mechanism, to enable proper grounding. Flexible conductors of adequate cross section shall be provided at the lower end of the vertical operating shaft for connection to the station ground.
- v. Push button for local control shall be provided on the mechanism housing and the control switch for remote control from the main control board shall be provided by the control panel manufacturer. A local/remote change over switch shall also be provided in the mechanism cubicle.
- vi. The operating motors for electrically operated isolators shall be of the totally enclosed, outdoor type, suitable for 415+/- 10% Volts, AC 3 phase, 50 Hz supply. The motor shall be adequately rated sufficient to operate the isolator smoothly.
- vii. The gear shall be made of aluminium and bronze alloy or EN8 material and lubricated for life with graphite or non drying and non hardening grease.
- viii. In the operating mechanism, mechanical stoppers shall be provided during both opening and closing operations of the driving motor shaft, in order to prevent over travel of the switch blade. This has to be demonstrated at the time of inspection/testing.
- ix. A lamp with a door switch and single phase preventer shall be provided on the

	PURCHASE SPECIFICATION FOR DESIGN,SUPPLY, E&C AND O&M OF 66KV S/Y BAY AT 10MW, KPCL-BELAKAVADI,MANDYA	PS-439-912
		REV NO: 00
		PAGE : 25 OF 64

motor operated mechanism. The space heater with thermostat control supply, On & Off switches as shall be provided.

- x. One set of extra NO/NC contacts for local/remote status shall be provided.
- xi. One set of contacts for thermal overload relay and single phase preventer shall be provided. A power socket of Industrial type shall be provided.
- xii. Gland plates shall be provided at the bottom of the motor operated mechanism box for cable connections. The required cable glands shall be supplied.
- xiii. The limit switches to be provided in the isolator covered under this order shall be of reputed make which are sturdy and moisture proof and reliable. The contacts of the limit switch shall be silver plated, sturdy and free from rusting.
- xiv. Operating mechanism housing box shall be outdoor type and weather proof to IP55 and fabricated out of not less than 12 SWG MS sheet tested quality with hinged doors. The housing shall be painted with inside and out side with two coats of enamel paint shade after treatment with 7 tank process. (Min. 70 microns)

5.5.7 TEMPERATURE RISE

The temperature rise for various parts shall be tested according to IS:9921 and IEC publication No.129.

5.5.8 INSULATION LEVEL

The isolators shall have minimum insulation levels as per IS:9921 and IEC publication No. 129.

5.5.9 CONTACTS

- i) The isolator shall be provided with high pressure self aligning adjustable silver plated copper contacts. The contacts shall be designed such that the contact pressure is released before any movement of the blades in the opening direction takes place and is applied after the closing travel is completed. The blades shall have a turn and twist movement in case of double break isolators so that there shall be sufficient wiping action of the contacts to make them self cleaning.
- ii) The earthing switches should be provided with three sets of suitable type of fixed contacts below the fixed contacts assemblies of the main switch on the incoming supply side and three sets of moving contacts having ganged operation. These contacts too should be fabricated out of electrolytic copper and dimensioned to withstand the rated currents.
- iii) The temperature rise of the contacts and other current carrying parts shall not exceed value specified in IS:9921 at an ambient air temperature of 40 Deg. C while carrying the rated current continuously. The temperature rise due to the passage of the rated short circuit current for a period of 1 sec shall not cause any annealing or welding of the contacts.
- iv) ARCING CONTACTS :
Arcing contacts provided shall close first and open last so that no damage due to arcing shall be caused to the main contacts.

	PURCHASE SPECIFICATION FOR	PS-439-912
	DESIGN,SUPPLY, E&C AND O&M OF 66KV S/Y BAY AT	REV NO: 00
	10MW, KPCL-BELAKAVADI,MANDYA	PAGE : 26 OF 64

5.5.10 **TERMINAL CONNECTORS**

Each isolator shall be provided with rigid type aluminium / bimetallic alloy connectors suitable for ACSR Aluminium conductor. The terminal connectors shall be suitable for horizontal or vertical take off. The required quantity of terminal connectors shall be supplied.

5.5.11 **ISOLATOR BLADES AND JAWS:**

- i) The isolator blades shall be HDEC (hard drawn electrolytic copper) tube of suitable thickness or one solid copper piece with contact surface silver plated. Construction shall be so designed that no part of the blade can move relative to the other parts. The thickness and section of the blade shall be such that it retains its form and straightness under all conditions of operation including the flow of system fault current for the specified period. It shall also be capable of withstanding all torsional and bending stress due to operation of the isolators. Wherever necessary, the blades shall be counter balanced by weights or springs. Fixed guides shall be provided so that proper seating of contacts will be achieved while closing even when a blade is out of alignment by 3 cm or less. The isolators to be supplied against this contract shall be employed with turn and twist motion and shall have no problem with the contact alignment. Further the main blade shall pass through the main actuator assembly without any joints so that there is no necessity of shunting by flexible copper conductors.
- ii) The sharp edges in the fixed contact terminal casting and bolt heads have to be rounded off to minimize the corona discharges. The ends of the blade arm pipes shall be suitably plugged by metal or nylon plugs to prevent entry of water or insects and corona discs shall be provided where ever necessary.

5.5.12 **AUXILIARY SWITCHES**

Auxiliary switches with a continuous current carrying capacity of 10 Amps and adequate thermal and breaking capacity shall be provided for all isolators and earthing switches for the remote position indication on the control board and for electrical interlocking with other equipments. The auxiliary switches shall be positively driven in both directions by rigid members. Ten pairs each of the normally open, normally closed contacts each for the main/earthing switches shall be provided. All contacts should be brought out on terminals. Provision shall be made for adding auxiliary switch contacts at a later date for isolators and earth switches. Separate auxiliary switches shall be provided for isolators and earth switches. The auxiliary switches shall be of robust construction and housed in weather proof and dust tight covers mounted on the respective operating mechanism and accessible even when the isolator is live.

5.5.13 **INTERLOCKS**

- i) For the purpose of making the operation of the isolator depending upon the position of the associated circuit breaker or other equipment as may be required at site, a suitable interlock should be provided on each isolator. The interlocks should be of robust design and contained in a weather proof and dust tight housing. The line isolator should close only when the corresponding circuit breaker and the earthing switch of the corresponding line are open. Electro

	PURCHASE SPECIFICATION FOR DESIGN,SUPPLY, E&C AND O&M OF 66KV S/Y BAY AT 10MW, KPCL-BELAKAVADI,MANDYA	PS-439-912
		REV NO: 00
		PAGE : 27 OF 64

magnetic type interlocking should also be provided to avoid wrong local operation of the isolator (manual or motor) when the corresponding circuit breaker is in closed position.

- ii) Besides the electrical interlocks, the earthing switches should be provided with mechanically operated interlock so as to ensure that: -
- a) It should be possible to close the earthing switch only when the isolating switch is in the fully open position.
 - b) It should be possible to close the isolating switch only when the earthing switch is in the fully open position.
 - c) The earth switch should not open automatically while attempting to close the isolator.
 - d) The operation of the earth switches should also be interlocked with the CVTs/CTs supplies from the transmission line i.e. it should be possible to close the earth switch only when the line is dead from the feeding end, and there is no supply from the secondaries of the line CVTs/CTs.
 - e) The operation of earth/isolating switch should not take place when the corresponding isolator/earth switch is in operating stroke.

5.5.14 BEARINGS

The design and construction of the various bearings shall embody all the features required to withstand climatic conditions specified so as to ensure dependable and effective operations even after long periods of inaction of these isolators and switches. Facilities should be provided for lubrication of the bearings. All bearings shall be filled with first filling of grease and provided with grease nipples for greasing during servicing.

5.5.15 GALVANISED SUPPORT STRUCTURES

The required quantity of galvanized steel support structures for mounting the isolator on the ground shall be supplied for mounting the isolators in upright positions. The galvanized steel support structures shall in general conform to the latest issue of IS2629.

5.5.16 DESIGN, MATERIALS & WORKMANSHIP

The contractor shall assume full responsibility for co-ordination and adequate design. All materials used in the construction of the equipment shall be of the appropriate class, well finished and of approved design and make. All similar parts should be accurately finished and interchangeable.

All ferrous parts shall be hot dip galvanized. Bolts, nuts, pins and washers etc., used on the isolators shall also be galvanized. Special attention shall be paid to give tropical treatment to all the equipment as they will be subjected during service to extremely severe exposure to atmospheric moisture and to long period of high ambient temperature. All current carrying parts shall be of non-ferrous metal or alloys and shall be designed to limit sharp points, edges and similar sharp faces.

5.5.17 FASTENERS

Nuts, bolts, studs and washers for use in the plant shall conform to the requirements of the appropriate standards, where the contract includes nuts and



**PURCHASE SPECIFICATION FOR
DESIGN,SUPPLY, E&C AND O&M OF 66KV S/Y BAY AT
10MW, KPCL-BELAKAVADI,MANDYA**

PS-439-912

REV NO: 00

PAGE : 28 OF
64

bolts of different standards, the necessary tools shall be provided in compliance with this specification and shall include spanners, taps and dies for these nuts and bolts.

5.5.18 TESTS

Each isolator and earth switch shall strictly comply with the requirements of all the approved type tests and shall be subjected to all routine/acceptance tests stipulated in the relevant standard.

5.5.19 GUARANTEED TECHNICAL PARTICULARS

The isolator supplied shall comply with the Guaranteed technical particulars as indicated below.

1	Rated voltage	72.5 kV
2	Nominal System voltage	66 kV
3	Rated frequency	50 Hz
4	System neutral earthing	Effectively earthed
5	Installation	Out door
6	Type of disconnect	Horizontal double break
7	Number of poles	3
8	Rated normal current	To be furnished by vendor as per design requirement.
9	Rated short time with-stand current (KA rms)	31.5 kA for 3 sec.
10	Rated peak withstand current for both main and earth switch (KA) peak	To be furnished by vendor as per design requirement
11	Rated insulation level 1.2/50 micro second lightning impulse withstand voltage (kV) peak	
	a)between live parts and ground	To be furnished by vendor as per design requirement.
	b)across the open terminal of the same phase	To be furnished by vendor as per design requirement.
12	One minute dry/wet power frequency withstand voltage for complete assembled isolator / isolator cum earthing switch.	
	a) against ground (kV) rms	To be furnished by vendor as per design requirement.
	b) across terminals of open isolator (kV) rms	To be furnished by vendor as

	PURCHASE SPECIFICATION FOR	PS-439-912
	DESIGN,SUPPLY, E&C AND O&M OF 66KV S/Y BAY AT	REV NO: 00
	10MW, KPCL-BELAKAVADI,MANDYA	PAGE : 29 OF 64

		per design requirement.
13	Minimum clearance in open air (mm)	
	a) Between phases	To be furnished by vendor as per design requirement.
	b) Live parts and ground	To be furnished by vendor as per design requirement.
14	Rated magnetizing current/ capacitive current make/break capacity	To be furnished by vendor as per design requirement.
15	Rated mechanical terminal load	
	a) Straight load (Kg)	To be furnished by vendor as per design requirement.
	b) Across load (Kg)	To be furnished by vendor as per design requirement.
16	Operating mechanism	Motor operated
17	Operating time	10 – 12 sec
18	Particulars of insulators	
	a) Creepage distance (mm)	To be furnished by vendor
	i) Total	To be furnished by vendor
	ii) Protected	At least 50% of total Creepage distance
	b) Dielectric strength(kV)	Wet: and Dry: To be furnished by vendor
	i) Minimum one minute power frequency withstand voltage (kV) rms	To be furnished by vendor
19	No. of auxiliary switch contacts (NO , NC)	10 nos. each

NOTE: The above details are tentative. Vendor shall submit complete details to BHEL for approval during detailed engineering.

5.6 CURRENT TRANSFORMERS :

5.6.1 TYPE AND RATING

The 72.5 kV Current transformers shall be Outdoor, Dead tank type, Copper wound, single phase, 50 Hz, oil immersed, self-cooled and suitable for operation under site climatic conditions without any protection from sun and rain.

5.6.2 STANDARDS

The Current transformers shall comply with the latest issue of IS 2705 (Part I, II, III and IV) or IEC 185 or the latest revised standards such as IEC61869 Part2 except where specified otherwise. Equipment meeting any other authoritative standard,

	PURCHASE SPECIFICATION FOR	PS-439-912
	DESIGN,SUPPLY, E&C AND O&M OF 66KV S/Y BAY AT	REV NO: 00
	10MW, KPCL-BELAKAVADI,MANDYA	PAGE : 30 OF 64

which ensures an equal or better quality than the standard mentioned above, is also acceptable.

5.6.3 GENERAL

- i) The Current transformers shall be of single phase, oil immersed and self-cooled, suitable for the services indicated, complete in all respects, conforming to the modern practice of design and manufacture.
- ii) The core shall be of high grade, non-ageing, electrical grade silicon laminated steel of low hysteresis loss and high permeability to ensure high accuracy at both normal and over-currents or voltages.
- iii) The current transformers shall be sealed to eliminate breathing and prevent air and moisture from entering the tank. These shall be provided with oil level gauge and a pressure relieving device capable of releasing abnormal internal pressure. The temperature rise shall be as specified in the latest IS 2705.
- iv) Secondary terminals of current transformers shall be brought out in a weatherproof terminal box. Glands and lugs for terminating cable connections shall be provided.
- v) Terminal and polarity marks shall be indelibly marked on each current transformer on the associated terminals and these marks shall be in accordance with relevant standards.
- vi) The current transformers shall be provided with the following accessories.
 - a) Primary terminal connectors suitable for ACSR conductor.
 - b) Two earthing terminals on tanks on opposite sides for connecting earthing conductors.
 - c) Oil level gauge.
 - d) Filling and draining plugs.
 - e) Power factor testing terminal
 - f) Facility for lifting bushings and tank.
 - g) The quantity of insulating oil required for first filling. Di electric dissipation factor of the oil shall not exceed 0.005. Insulating oil shall comply with applicable standards.
 - h) Rating and diagram plate as per relevant standards.
 - i) Pressure relieving device.
- vii) Current transformers shall be given tropicalised treatment for satisfactory operation in hot and humid condition.
- viii) The temperature rise shall not exceed the figures given in applicable standards for operation under ambient temperature conditions.
- ix) The tanks/bases and all exposed ferrous parts shall be hot dip galvanized and painted conforming to applicable standards.
- x) In the case of multi-core CTs, it shall be possible to adjust the tap settings on any core independent of the setting on the other cores, for which purpose these tapings will have to be provided on the secondary windings.
- xi) In case of multi-ratio current transformers, min specified requirements for VA, accuracy, knee-point voltage and max secondary resistance shall be met at all

	PURCHASE SPECIFICATION FOR	PS-439-912
	DESIGN,SUPPLY, E&C AND O&M OF 66KV S/Y BAY AT	REV NO: 00
	10MW, KPCL-BELAKAVADI,MANDYA	PAGE : 31 OF 64

taps.

- xii) Magnetizing characteristics (extending well beyond knee point voltage) and secondary impedance values shall be furnished for all protection cores.
- xiii) Termination: No scissor type lugs to be employed. Only round lugs shall be used.

5.6.4 INSULATORS/BUSHINGS

- i) Insulators / bushings shall conform to applicable standards and shall be made of homogeneous vitreous porcelain, the glazing of which shall be of uniform brown or dark brown in colour.
- ii) Oil filled insulators/bushings shall be hermetically sealed to prevent ingress of moisture. Metallic bellows/Nitrogen gas shall be used for cushioning and to allow for expansion.

5.6.5 TESTS:

- i) The following routine tests shall be carried out on all the current transformers in the presence of BHEL / BHEL customer representative as per the relevant latest IS and 6 sets of test certificates shall be furnished for approval before despatch. No equipment shall be despatched before the approval of test certificates and despatch instructions are conveyed by the purchaser.
 - a) Verification of terminal markings and polarity.
 - b) Power frequency voltage with stand test on primary windings.
 - c) Power frequency voltage with stand test on secondary windings.
 - d) Over voltage inter turn test.
 - e) Determination of errors according to the requirements of the appropriate accuracy class.
 - f) Partial discharge test.
- ii) The following type tests shall be carried out on one of the current transformers. If the contractor has already carried out type test on similar equipment in last 3 years, a copy of the same shall be furnished for purchaser's reference. If type test is not carried out, the same shall be conducted free of cost and test certificates furnished for purchaser's approval.
 - a) High voltage power frequency test on primary windings.
 - b) High voltage power frequency test on secondary windings.
 - c) Determination of errors according to the requirements of the appropriate accuracy class.
 - d) Short time current test.
 - e) Temperature rise test.
 - f) Impulse voltage test.
- iii) A copy of the type test certificate for the following type tests carried out on one of the bushings shall be furnished for BHEL / BHEL customer reference.
 - a) Power frequency visible discharge test.
 - b) One minute power frequency withstand test.
 - c) Full wave impulse voltage withstand test.
 - d) Under oil flash over or puncture withstand test.

	PURCHASE SPECIFICATION FOR DESIGN,SUPPLY, E&C AND O&M OF 66KV S/Y BAY AT 10MW, KPCL-BELAKAVADI,MANDYA	PS-439-912
		REV NO: 00
		PAGE : 32 OF 64

5.6.6 GUARANTEED TECHNICAL PARTICULARS :

The current transformers supplied shall comply with guaranteed technical particulars as indicated below.

#	Particulars	Guaranteed values			
1	Nominal system voltage	66 KV			
2	Rated Voltage	72.5 KV			
3	Rated frequency	50 Hz			
4	System neutral earthing	Effectively earthed			
5	Installation	Out door			
6	Rated short circuit current	31.5 KA			
7	Rated insulation level				
	i) Impulse With stand voltage	350 KV Peak			
	ii) 1 min power frequency withstand voltage	160 KV rms			
8	Continuous current rating	120% of rated primary current			
	Description	CORE1	CORE2	CORE3	CORE4
	Ratio	To be furnished by vendor as per design requirement.			
	Rated primary current				
	Rated sec. current				
	Purpose				
	Adopted ratio				
	Accuracy Class				
	Rating of VA burden				
	Min Knee point voltage				
	RCT @ 200/1A				

NOTE: The above details are tentative. Vendor shall submit complete details to BHEL for approval during detailed engineering.

5.7 POTENTIAL TRANSFORMER

- i) Potential transformer, design, Temperature rise and testing etc. should be in accordance with IEC: 186 or the latest revised standards such as IEC61869
- ii) The PTs should be single phase oil immersed self-cooled type suitable for outdoor installation of kV class required. The core should be of high grade non

	PURCHASE SPECIFICATION FOR	PS-439-912
	DESIGN,SUPPLY, E&C AND O&M OF 66KV S/Y BAY AT	REV NO: 00
	10MW, KPCL-BELAKAVADI,MANDYA	PAGE : 33 OF 64

ageing electrical silicon laminated steel of high permeability. The PTs should be hermetically sealed to eliminate breathing and prevent air and moisture entering the tank. Oil level and pressure releasing device etc. should be provided.

iii) Temperature Rise

The maximum temperature of the windings, cores etc. should not exceed 45°C over ambient, while max. Temperature of oil at top should not exceed 35°C over ambient. The PTs should be suitable for mounting on steel structures. All nuts, bolts, flanges and base should be hot dip galvanized. The terminal connectors should be such as to give intimate contact between conductor & terminal and offer protection against and effects of electrolytic and atmospheric corrosion and should also have sufficient mechanical strength. The connectors should conform IS 5556: 1970.

iv) Termination: No scissor type lugs to be employed. Only round lugs shall be used.

5.7.1 GUARANTEED TECHNICAL PARTICULARS :

The potential transformers supplied shall comply with Guaranteed technical particulars as indicated below..

1	Rated voltage	72.5 kV
2	Rated frequency	50 Hz
3	Accuracy class of Winding	as required
4	Number of cores	Min 2. (1 for metering, 1 for protection).
5	Voltage ratio	66 kV/ $\sqrt{3}$, 110V/ $\sqrt{3}$
6	Grade of oil	As per IS: 335
7	Max phase angle error with 25% and 110% of rated burden at 0.8 p.f. lagging at any voltage between 80% and 120%	To be furnished by vendor as per design requirement.
8	Temperature rise at 1-1 times rated voltage with rated burden (OC)	As per IS: 3156
9	Rated voltage factor & time (based on system studies) Continuous & 30 seconds:	To be furnished by vendor as per design requirement.
10	Insulation Level (based on system insulation coordination)	i) 1 minute power frequency (wet/dry) withstand test voltage (As per IS: 3156): To be furnished by vendor as per design requirement.
		ii) 1.2/50 micro seconds impulse withstand test voltage: To be furnished by vendor as per design requirement.
11	One minute power frequency withstand test voltage on secondary sides	To be furnished by vendor as per design requirement.
12	Minimum creepage distance of bushings	To be furnished by vendor as per design requirement.

NOTE: The above details are tentative. Vendor shall submit complete details to BHEL for approval during detailed engineering.

	PURCHASE SPECIFICATION FOR DESIGN,SUPPLY, E&C AND O&M OF 66KV S/Y BAY AT 10MW, KPCL-BELAKAVADI,MANDYA	PS-439-912
		REV NO: 00
		PAGE : 34 OF 64

5.8

MARSHALLING BOXES :

- i) The Marshalling boxes shall be suitable for mounting on the support structures. The Marshalling box is required for connecting the secondary windings of the corresponding individual core of the CTs and PT's of the three phases in star or delta as the case may be and to take leads from the marshalling box to the Control and Protection Panel. The quantity of marshalling boxes shall be supplied to meet the requirement. The size of cables used for connecting CT and PT leads upto the marshalling box shall be of 16 mm², copper cable.
- ii) **STANDARDS:**
The marshalling boxes shall conform to modern design practice and shall be strictly in line with the specification described here in below.
- iii) **DETAILED TECHNICAL SPECIFICATION:**
The marshalling boxes shall consist of completely enclosed cubicle type steel boxes suitable for outdoor mounting. These boxes shall be fabricated out of not less than 12 SWG thick mild steel cold rolled sheet of tested quality complying with the latest edition/ amendment of IS: 513/1973.

The marshalling boxes shall have a single door hinged at two places. The hinges shall be of such construction that the door can swing open by not less than 150 deg. The door shall also be provided with suitable size best quality mortise lock. The complete box shall be fabricated in such a way that when closed it shall be perfectly water tight, dust proof and vermin proof and enclosure shall conform to IP 55 as per IS: 2147.

All marshalling boxes shall be provided with necessary fixtures for fixing the cable entry and exit pipes with check nuts on all the sides of the marshalling box and accessories.

- iv) **TERMINAL BLOCKS :**
The materials used for the terminal blocks shall possess excellent mechanical and electrical properties. The terminal blocks shall be rigid and shall withstand handling while making repeated terminations. The terminal blocks shall be of stud type (Bolt and nut type) and shall be suitable for 16 sq. mm cable of reputed make. Each unit shall be complete with copper terminal studs, nuts and washers together with label carriers, with blank label strips and suitable cable lugs. The terminal block shall be mounted on galvanized rolled steel strip of sufficient length and size which acts as a support bar for fixing on hylem sheet of 10 mm thick brass studs. Each terminal block shall be suitably numbered. Spare terminals shall also be provided for future use.

Then terminal studs, nuts, washers and links shall be made of best quality copper and shall be suitable for copper conductor of size 16 sq. mm.

Sufficient quantity of suitable size cable lugs for copper conductor of size 16 sq. mm shall be supplied.

	PURCHASE SPECIFICATION FOR DESIGN,SUPPLY, E&C AND O&M OF 66KV S/Y BAY AT 10MW, KPCL-BELAKAVADI,MANDYA	PS-439-912
		REV NO: 00
		PAGE : 35 OF 64

All terminal blocks shall be designed for voltage rating of 1100 volts and continuous current rating of 25 A, AC or DC.

The terminals shall be of good mechanical construction providing adequate electrical contact for the appropriate size of the copper cable used.

Terminal connectors shall be such that the conductors may be connected by screw or other equivalent means to maintain the necessary contact pressure permanently.

Terminals shall not run or be displaced when the connecting screws are tightened and the conductor shall not become displaced.

Terminals shall be so mounted that the appropriate wire or cable may be connected without impairing the normal performance of the unit. No contact pressure shall be transmitted through insulating material and the gripping of the conductor shall take place between metal faces.

v) **EARTHING TERMINAL:**

Two numbers of 12 mm diameter brass bolts and nuts with spring washers for each box shall be provided by the side of the body of the marshalling box for fixing copper / GI 50x6 mm flat. The earthing terminal shall be identified by means of the sign marked, in a legible and indelible manner on or adjacent to the terminal. The terminals shall be provided inside the marshalling box for connection of earthing leads. Earthing terminal shall have provision for terminating the earthing leads from neutral connection at the inside of the box.

Suitable size cubicle heater and illuminating lamp with independent control switch shall be provided inside each marshalling box. The illuminating lamp shall be automatically switched on when the door is opened.

The auxiliary supply voltage available is 240 +/-10% V, AC.

The general arrangement and other drawings pertaining to the marshalling boxes shall be submitted. The Bill of materials shall be indicated in the general arrangement drawing of marshalling box.

vi) **TESTS AND TEST CERTIFICATE:**

The marshalling boxes shall withstand the insulation test of 2kV AC(RMS) between terminals and earth or between adjacent terminals for one minute.

All tests shall be conducted on the CT marshalling boxes in accordance with relevant IS(IS standard considered to be furnished in offer) in presence of the purchaser or his representative or else reports of the tests conducted on similar type of marshalling boxes in the last 3 years shall be submitted.

	PURCHASE SPECIFICATION FOR	PS-439-912
	DESIGN,SUPPLY, E&C AND O&M OF 66KV S/Y BAY AT	REV NO: 00
	10MW, KPCL-BELAKAVADI,MANDYA	PAGE : 36 OF 64

- vii) **PAINTING :**
The marshalling boxes shall be painted both inside and outside so as to with stand highly humid atmosphere.

5.8.1 The switchyard bay shall be provided with a Bay Marshalling Kiosk located at a convenient location to receive and distribute cables within the bay. It shall meet all the requirements as specified for cabinets/boxes above.

It shall have the following features:

- a) Receiving and distributing appropriate number of incomers and outgoers with suitable rating of MCB's.
- b) Terminal blocks for connecting
 - i) All CT and PT circuits.
 - ii) All AC and DC power supply circuits.
 - iii) All other control and signalling circuits.

The terminal blocks for CT and PT secondary leads shall be provided with test links and isolating facilities. CT secondary leads shall be provided with short circuiting and earthing facilities.

ALL necessary requirements for testing of equipments in the switchyard shall be provided.

20% additional terminal blocks shall be provided as spares.

5.9 **60 KV ZINC OXIDE LIGHTNING ARRESTERS**
5.9.1 **TYPE AND SYSTEM DATA**

The lightning arresters shall be of 60 KV, gapless zinc oxide and suitable for outdoor operation without protection from sun and rain.

5.9.2 **STANDARDS:**

The lightning arresters and associated accessories shall conform to the requirement of the latest IS: 3070 (part-I), IEC: 60099-4 for the gapless zinc oxide lightning arresters.

5.9.3 **DEFINITIONS:**

For the purpose of this specification, all technical terms used herein shall have the meaning as defined in IS: 3070 (part-I), IEC: 60099-4 for gapless zinc oxide lightning arresters with latest revision thereof, if any.

5.9.4 **CONSTRUCTIONAL FEATURES**

- i) The arresters shall be of modern design consisting of hermetically sealed units incorporating non-linear resistors (metal oxide) stacked vertically. The arresters shall be designed to have adequate thermal discharge capacity for severe switching surges, long duration surges and multiple strokes. The arresters shall be suitable for mounting on outdoor structures.
- ii) Supporting structures, terminal connectors, grading ring and other components shall form part of the arresters. All metal parts shall be of non-rusting and non-corroding metal. Bolts, screws and pins shall be provided with lock washers, keys or equivalent locking facilities. All similar parts, particularly removable ones shall be interchangeable. Self-contained **discharge counter**, requiring no auxiliary



**PURCHASE SPECIFICATION FOR
DESIGN,SUPPLY, E&C AND O&M OF 66KV S/Y BAY AT
10MW, KPCL-BELAKAVADI,MANDYA**

PS-439-912

REV NO: 00

PAGE : 37 OF
64

battery supply shall be provided for each single pole unit. The terminals shall be robust and shall be located such that incoming and outgoing connections could be made with minimum possible bends. Suitably sized by-pass shunts of copper to facilitate by-passing the discharge counter shall be designed and supplied. The design of the terminal connectors shall permit the connection of these units.

- iii) A leakage current detector as an integral part of the discharge counter shall be provided. The value of the leakage current beyond which the operation is prohibitive shall be clearly indicated in red colour on the detector.
- iv) The arresters shall be provided with pressure relief diaphragm at both ends. Corona rings wherever used shall be of non-magnetic materials.
- v) Lightning arresters shall be gapless metal oxide hermetically sealed type, of self-supporting construction and base mounted suitable for mounting on steel structures. They shall have adequate thermal discharge capacity for various types of surges. The lightning arresters shall be capable of withstanding the internal pressures developed during discharges without operation of the pressure relief devices or should safely vent the internal pressures associated with arrester failure without shattering
- vi) Insulator housing shall be porcelain having adequate mechanical strength and integrity. Arrester housing shall withstand short circuit, wind, seismic and other forces during operation.
 - i) Arresters shall incorporate anti contamination feature to prevent arrester failure consequent to uneven voltage gradient across the stack in the event of contamination of the porcelain. The arrester shall be protected against the ingress of moisture.
 - ii) Surge counter should be supplied with the insulating bases for connection. No radio interference shall be caused by the arresters operating at the normal rated voltages.

5.9.5 RECTANGULAR WAVE SHAPE CURRENT

The arrester shall withstand surges of low magnitude rectangular wave shape currents of long duration arising from switching surges or accumulation of static charges from atmosphere.

5.9.6 INSULATING CASING:

The insulating casing shall conform to relevant IS standards (IS standard considered shall be indicated in the offer) with latest amendments. Insulating casing shall be made of wet process, non-porous electrical porcelain, free from imperfection and moisture absorption, vitrified and finished with brown glaze and designed to keep the insulator surface from contamination by natural action of wind and rain. The leakage distance along with external surface shall be large to ensure that the surface contamination likely to deposit in the specified weather conditions shall minimize radio interference.

The complete bushing insulator casing per pole of the arrester shall withstand the following insulator insulation tests:

- i) Insulation class of bushing : 66 kV

	PURCHASE SPECIFICATION FOR	PS-439-912
	DESIGN,SUPPLY, E&C AND O&M OF 66KV S/Y BAY AT	REV NO: 00
	10MW, KPCL-BELAKAVADI,MANDYA	PAGE : 38 OF 64

- ii) Power frequency withstand
 - 1 Min dry : 160 kV rms
 - 1 Min wet : 160 kV rms
- iii) 1.2 / 50 micro second wave : 350 kV peak

NOTE: The insulator of each unit arrester of which the pole arrester is stacked shall withstand pro rata voltage specified above in proportion with the ratio of the number of elements housed in the unit arrester to the total number of them in each pole arresters.

5.9.7 TYPE OF MOUNTING

Lightning arresters shall be suitable for mounting on steel support structures to be supplied. The necessary flanges, foundation bolts or clamp, nuts washers etc., for the base of arresters shall be supplied and these shall be hot dip galvanized. Insulating bases required for mounting of the arresters with attachment of surge counters shall be supplied.

5.9.8 GALVANISED SUPPORT STRUCTURES

The contractor shall supply along with the LAs all the support structures and foundation bolts, nuts and washers required. The galvanized steel support structures shall in general conform to the latest edition of IS 2629.

5.9.9 FITTINGS AND ACCESSORIES:

- i) Arresters shall be complete with insulating base for connection of discharge counter and provision for bolting to the supporting structure (pedestal).
- ii) Self-contained discharge counter, suitably enclosed for outdoor use weather and waterproof and requiring no external supply shall be provided for each 60 kV arrester. The discharge counter shall have a glass window. Suitably sized links of copper to facilitate bypassing of discharge counter shall be provided. The terminal connectors shall have provision for connection of these links.
- iii) The conductor between lightning arrester earth terminal to the discharge counter terminal shall be insulated for a minimum of 4 kV and required length of insulated conductor shall be supplied along with the arrester. It shall not require sealing ends or plumbed joints at their ends for terminations.
- iv) A leakage current detector as an integral part of the discharge counter shall be supplied.
- v) Arresters shall be supplied with clamps/connectors on line terminal, earth terminal and the discharge counter terminals along with galvanized steel support structures with bolts, nuts etc., including foundation requirements. Suitable bimetallic type connectors, if any, to receive ACSR conductor shall be provided and shall be suitable for both horizontal and vertical connections.

5.9.10 TESTS

- i) The vendor shall submit a copy of the type test certificate for the similar type of arresters conducted within the last 3 years for BHEL reference. If the type test are not conducted, the same shall be conducted free of cost and test reports furnished for BHEL approval.



**PURCHASE SPECIFICATION FOR
DESIGN,SUPPLY, E&C AND O&M OF 66KV S/Y BAY AT
10MW, KPCL-BELAKAVADI,MANDYA**

PS-439-912

REV NO: 00

PAGE : 39 OF
64

- ii) The lightning arrester shall comply with the tests prescribed in IS & IEC specifications.
- iii) The manufacturer shall conduct the following tests on all lightning arrester at their works, in the presence of BHEL representative, as per the latest edition of IS & IEC specifications:
- a) Routine tests: All routine tests shall be conducted on the arrestors by the supplier and test certificates furnished.
- b) The following Acceptance tests on complete lightning arrester shall be conducted:
- Measurement of power frequency reference voltage.
 - Measurement of lightning impulse residual voltage.
 - Measurement of partial discharge.
 - Visual and dimensional checks.
 - Test on discharge counter.
 - Switching surge, residual voltage tests.
- iv) The BHEL representative shall have access to the works for the purpose of inspecting the manufacture of equipment.
- v) The Routine test/ Acceptance test certificates shall be furnished in 6 sets for BHEL / BHEL customer approval and conveying despatch instructions. No equipment shall be despatched before the approval of test certificates and despatch instructions are conveyed by BHEL / BHEL customer.

5.9.11

GUARANTEED TECHNICAL PARTICULARS

The lightning arresters supplied shall comply with guaranteed technical particulars as indicated below.

#	Particulars	Details
1	Lightning arrester type	Gapless metal oxide outdoor type.
2	Rated voltage	60 kV rms.
3	Nominal system voltage	66 kV rms.
4	Highest system voltage	72.5 kV rms.
5	Nominal discharge current	10 KA peak
6	Max current at operating voltage	20 mA
7	Maximum continuous operating voltage	51 kV rms.
8	Steep current impulse residual voltage	190 kV peak
9	Long duration discharge class	3
10	One minute wet power frequency withstand Voltage of arresters housing	160 kV rms.
11	Rated insulation level	
	a) Impulse With stand voltage	350 kV Peak
	b) 1 minute power frequency withstand voltage of arrester housing	140 KV rms



**PURCHASE SPECIFICATION FOR
DESIGN,SUPPLY, E&C AND O&M OF 66KV S/Y BAY AT
10MW, KPCL-BELAKAVADI,MANDYA**

PS-439-912

REV NO: 00

PAGE : 40 OF
64

12	Pressure relief device	Class A
13	High current short duration test value	100 KA peak
14	Single impulse energy capability	4.5 kJ per KV
15	Creepage distance of arrester housing	1815 mm. minimum

NOTE: The above details are tentative. Vendor shall submit complete details to BHEL for approval during detailed engineering.

**5.10
5.10.1**

**STRUCTURES
GENERAL**

The scope of specification covers fabrication, assembly, supply and erection of gantry and equipment structure. Gantry and support structure suitable for 66KV switchyard shall be fabricated from structural steel conforming to IS 2062 (latest). The gantry shall be designed for a minimum height of 10 meters above the ground with adequate clearance between the conductors and from the ground as per relevant IS(standard considered to be indicated). Adequate height of all the structures must be provided to maintain proper clearances. It is stressed that the contractor has to provide adequate steel sections as per the standard. However, if a higher section is required from design point of view, the same shall be acceptable to BHEL. Additional structures, called stools, shall be provided between the equipment and its support structures to match the bus bar height. The top of stool shall be connected to the equipment and the bottom of the stool shall be connected to the support structures. All fabrication drawings of structures shall be furnished to BHEL for Prior Approval.

The scope shall include all types of bolts, nuts, shackles, clamps, step bolts, inserts in concretes, gusset plates, equipment mounting bolts, structure earthing bolts, foundation bolts, spring washers, fixing plates, angles and bolts .

The connection of all structures to their foundations shall be by base plates and embedded anchor/ foundation bolts. All steel structures and anchor/foundation bolts shall be fully galvanized. The weight of the zinc coating shall be as per the standard for anchor/ foundation bolts and for structural members. One additional nut shall be provided below the base plate, which may be used for purpose for leveling.

Note: a) As per the site conditions, the shall design, supply and erect the required quantity of mounting structures and gantry.

5.10.2

Design ,Drawings, Bill of materials and document

Vendor shall furnish a list of documents (design, drawing, BOMs) with the tender, which intends to submit to KPCL/BHEL. Vendor shall necessarily submit all these documents, unless KPCL/BHEL waives any documents. However, VENDOR shall prepare and submit any other drawings, BOMs and reference in addition to the documents contained in the list furnished by BHEL.

	PURCHASE SPECIFICATION FOR	PS-439-912
	DESIGN,SUPPLY, E&C AND O&M OF 66KV S/Y BAY AT	REV NO: 00
	10MW, KPCL-BELAKAVADI,MANDYA	PAGE : 41 OF 64

5.10.3 Fabrication of Steel

The fabrication and erection works shall be carried out generally in accordance with IS: 802 (latest). A reference however may be made to IS: 800 (latest) in case of non-stipulation of some particular provision in IS: 802 (latest). All materials shall be completely shop fabricated and finished with proper connection material and erection marks for ready assembly in the field.

5.10.4 ASSEMBLY

- i) The component parts shall be assembled in such a manner that they are neither twisted nor otherwise damaged and shall be so prepared that the specified camber, if any, is provided. In order to minimize distortion in member the component parts shall be positioned by using the clamps, clips, dogs, jigs and other suitable means and fasteners(Bolts & welds)shall be placed in a balanced pattern. If the individual components are to be bolted, paralalled and tapered, drifts shall be used to align the part so that the bolts can be accurately positioned.
- ii) Sampled towers, beams and lightening masts shall be trial assembled keeping in view the actual site conditions, before erection, in the fabrication shop and shall be inspected and approved by BHEL/KPCL before mass fabrication. Necessary match marks shall be made on these components in the shop before disassembly and dispatching.

5.10.5 BOLTING

- i) Every bolt shall be provided with a spring washer under the nut so that no part of the threaded portion of the bolt is within the thickness of the parts bolted together.
- ii) All steels, bolts, nuts and washers shall be hot dip galvanized.
- iii) 2% extra nuts and bolts shall be supplied for erection.

5.10.6 Welding

The works shall be done as per approved fabrication drawing which clearly indicate various details of joints to be welded, type of weld, length and size of weld, whether shop or site weld. Symbols for welding on erection and shop drawings shall be according to IS: 813. Efforts shall be made to reduce site welding so as to avoid improper welding due construction difficulties.

5.10.7 Foundation Bolts

- i) Foundation Bolts for the towers and equipment supporting structures and elsewhere shall be embedded in first stage concrete while the foundation is cast. The VENDOR shall ensure the proper alignment of these bolts to match the holes in the base plate.
- ii) The VENDOR shall be responsible for the correct alignment and leveling of all steel work on site to ensure that the towers/structures are plumb.
- iii) All foundation bolts shall be fully galvanized.

	PURCHASE SPECIFICATION FOR DESIGN,SUPPLY, E&C AND O&M OF 66KV S/Y BAY AT 10MW, KPCL-BELAKAVADI,MANDYA	PS-439-912
		REV NO: 00
		PAGE : 42 OF 64

- 5.10.8 Stability of structure**
The VENDOR shall be responsible for the stability of the structure at all the stages of its erection at site and shall take all necessary measures by the additions of temporary bracings and guying to ensure adequate resistance to wind and also to loads due to erection equipments and their operations.
- 5.10.9 Grouting**
The method of grouting the column bases shall be subject to approval of BHEL/KPCL and shall be such as to ensure a complete uniformity of contact over the whole area of the steel base.
- 5.10.10 Galvanizing**

All structural steel works and single pipe supports shall be galvanized after fabrication as per IS: 2629 (Latest) IS: 4759 (Latest).

Zinc required for galvanizing shall have to be arranged by the manufacturer. Purity of zinc to be used shall be 99.5% as per IS: 209 (Latest revision).

The VENDOR shall be required to make arrangement for frequent inspection by BHEL/KPCL as well as continuous inspection by a resident BHEL/KPCL representative, if so desired for fabrication work.
- 5.10.11 Inspection before dispatch**
Each part of the fabricated steel work shall be inspected and certified by BHEL representative as satisfactory before it is dispatched to the erection site. Such certification shall not relieve the contractor of his responsibility regarding adequacy and completeness of fabrication.
- 5.10.12 Test certificate**
Copies of all test certificate relating to the materials procured by the contractor for the works shall be forwarded to the owner.
- 5.10.13 Erection**
The VENDOR should arrange his own erection plant and equipment welding set tools and tackles, scaffolding, trestles equipment etc. and other accessories and ancillaries required for the work. The erection work shall be started after concrete has acquired its full strength. The members shall not be subjected to any undue stress, damage to steel or galvanizing during erection.
- 5.10.14 Safety precautions**
The contractor shall strictly follow at all stages of fabrication, transportation and erection of steel structures, raw materials and other tools and tackles, the stipulations contained in Indian standard code for erection for structural steel work as per IS:7205 (latest revision).

	PURCHASE SPECIFICATION FOR DESIGN,SUPPLY, E&C AND O&M OF 66KV S/Y BAY AT 10MW, KPCL-BELAKAVADI,MANDYA	PS-439-912
		REV NO: 00
		PAGE : 43 OF 64

5.11 ACSR CONDUCTORS AND STEEL WIRES
ACSR conductor for auxiliary bus extension from transformer to the line bays and for equipment interconnection is to be supplied under this contract.

5.11.1 CODES AND STANDARDS

- i) The conductors shall comply with all currently applicable statutes, regulations and safety codes in the locality where the equipment will be installed. The equipment shall also conform to the latest applicable standards. .

5.11.2 MATERIAL

- i) Aluminum strands of ACSR conductor shall be hard drawn from 99.5% pure electrolytic Aluminum rods with 60 % TACC conductivity. The vendor shall specify the guaranteed minimum and average values of conductivity.
- ii) Chemical composition of the material shall comply with the requirements of relevant standards.
- iii) The surface of conductor shall be clean and dry and free from any excess grease that may be used in its fabrication. The surface strands shall be smooth and free from burrs and other projections which may be cause for increasing corona losses when the conductor is used on extra high voltage lines.

5.11.3 ACSR CONDUCTOR

Selection and type of conductor employed shall be furnished with complete design details.

i) GALVANIZING

The steel wire strands of ACSR conductor and steel conductor shall be hot dip galvanized. Zinc coating shall be evenly and uniformly coated complying with relevant standards.

ii) TESTS

All tests required on the required number of samples of raw materials and finished conductor as stipulated in the relevant standards shall be carried out.

iii) PACKING

- a) Conductor shall be wound on wooden drums made of sufficiently strong wood, and conforming to relevant standards from the conductor to outer edges of the drum shall be provided prior to lagging.
- b) All drums shall be painted inside and outside with Aluminum paint. All drums shall have a layer of water-proof paper around the drum under the conductor and another layer over the conductor and under the lagging.
- c) In addition to manufacturer's standard marking on the drums, batch of manufacture shall be clearly marked on each drum.

	PURCHASE SPECIFICATION FOR DESIGN,SUPPLY, E&C AND O&M OF 66KV S/Y BAY AT 10MW, KPCL-BELAKAVADI,MANDYA	PS-439-912
		REV NO: 00
		PAGE : 44 OF 64

5.12 INSULATORS

- 5.12.1** The porcelain shall be sound, free from defects, thoroughly vitrified and smoothly glazed. Insulators shall have compression type glaze with a good luster and of uniform brown color. The glaze shall be unaffected by sudden changes in temperature and by atmospheric pollution of Ozone, acids, alkali, dust etc.
- 5.12.2** Under surfaces and grooves shall be shaped for easy cleaning. Shells shall be substantially symmetrical in shape without appreciable warping. Tie wire grooves of pin insulators shall be formed to provide a firm support for the conductor and permit the making of a secure tie.
- 5.12.3** Insulators shall be designed to avoid excessive concentration of electrical stresses in any section or across leakage surfaces. Design features which increase radio influence level shall be avoided.
- 5.12.4** Each insulator shall have the rated strength marked clearly on the metal cap before galvanizing. Each insulator shall also have symbols identifying the manufacturer, month and year of manufacture etc.
- 5.12.5** All metal parts shall be made of good commercial grade malleable iron, or open hearth or electric furnace steel, hot dip galvanized conforming to relevant standards. Castings shall be free from blow holes, cracks and such other defects.
- 5.12.6** Strain and suspension string shall comprise of the conventional ball and socket type disc insulators. Individual insulators as well as strings of the same type shall be interchangeable with one another and it shall be possible to form either suspension or strain strings using the same discs. The locking clips shall be made of phosphor bronze and shall provide positive locking of the coupling.
- 5.12.7** The design of insulators shall be such as to avoid the following
- i) Stresses due to expansion and contraction in any part of the insulator shall not lead to deterioration.
 - ii) Stress concentration due to direct engagement with metal fittings
 - iii) Retention of water in the recesses of metal fittings
 - iv) Shapes, which do not facilitate easy cleaning by normal methods.

5.13 HARDWARE FITTINGS (GENERAL)

- i) Except where otherwise specified, all hardware shall be drop forged from high carbon steel.
- ii) All ferrous parts shall be hot dip galvanized conforming to relevant standards.
- iii) All clevis fittings and shackles shall be furnished with a high strength high carbon steel galvanized bolt with nut and cotter key.
- iv) All bolts and nuts shall have standard whit worth threads. All bolt heads and nuts shall be hexagonal and where required, the nuts shall be locked in an approved manner.
- v) Bolts shall be of sufficient strength to withstand without bending, the stresses introduced in them when they are stressed to their rated strength. The bolts shall be readily removable after the fittings have been so stressed.

	PURCHASE SPECIFICATION FOR DESIGN,SUPPLY, E&C AND O&M OF 66KV S/Y BAY AT 10MW, KPCL-BELAKAVADI,MANDYA	PS-439-912
		REV NO: 00
		PAGE : 45 OF 64

- vi) Locking and split pins shall be of hard drawn brass, bronze or stainless steel.
- vii) All castings shall be free from blow holes, cracks and other casting defects.
- viii) All current carrying parts shall be designed and manufactured to have minimum contact resistance.
- ix) Fittings intended to connect two dissimilar metals, shall be designed to avoid harmful bimetallic corrosion under service conditions.
- x) The surface of the equipment shall be smooth and free from sharp edges, burrs and other projections which may cause increased corona losses and radio interference voltage above acceptable levels.
- xi) The items of hardware and fittings shall make complete assemblies and shall include all bolts, nuts, washers, locknuts, cotter pins, and other miscellaneous pieces which are necessary or usual for their satisfactory performance and efficient maintenance. Such parts shall be deemed to be within the scope of this specification whether specifically mentioned or not.
- xii) The fittings shall be suitable for "Hot Line Maintenance work" such as replacing either whole or part of the insulator string by conventional methods with ease, safety and speed.
- xiii) Minimum breaking strength of insulator hardware shall not be less than that of insulator connecting string.
- xiv) Where parallel insulators are used, yoke plates at the top and bottom shall be of sufficient strength.
- xv) Insulating part, cap and pin shall be concentrically assembled using Portland cement or aluminous cement. When gripping the insulator between a ball (dummy) and a cap socket end (dummy), the radial run-out of the insulating part shall not exceed 8mm. With the same arrangement, the run-out of the insulating part shall not exceed 12mm. The axial run-out shall be measured at the periphery of the insulating part.
- xvi) Assembly shall be performed in such a way that the mechanical properties cannot be affected by the zinc. Furthermore assembly shall be carried out in such a way as to ensure that the insulating part shall not be subjected to any mechanical stress due to pressure exerted by the bottom edge of the cap.

5.14 CLAMP AND CONNECTORS

5.14.1 CODES AND STANDARDS

The clamps and connectors shall comply with all currently applicable statutes, regulations and safety codes in the locality where the equipment will be installed. The equipment shall also conform to the latest applicable standards. Standards followed shall be mentioned in the offer.

5.14.2 MATERIAL

The clamps and connectors shall be made of materials listed below wherever applicable.

For connecting AAC / ACSR	Aluminum Alloy Casting
---------------------------	------------------------



**PURCHASE SPECIFICATION FOR
DESIGN, SUPPLY, E&C AND O&M OF 66KV S/Y BAY AT
10MW, KPCL-BELAKAVADI, MANDYA**

PS-439-912

REV NO: 00

PAGE : 46 OF
64

For connecting equipment of Copper or with Brass to ACSR	Bimetallic connectors terminals made Aluminum alloy casting with +Copper alloy liner.
Bolts, Nuts, Plain washers spring washers	Hot Dip galvanized mild and steel
For connecting GI Shield wire	Malleable iron casting

5.15

CASTINGS

All castings shall be free from blow holes, surface blisters, cracks and cavities.

5.15.1

CONSTRUCTIONAL DETAILS

- i) All sharp edges and corners shall be blurred and rounded off.
- ii) Bolts and nuts shall have hexagonal heads and threads as per applicable standards. For bimetallic clamps or connectors
- iii) Copper alloy liner or minimum thickness 4 mm shall be cast integral with the Aluminium alloy body.
- iv) Flexible connectors, braids or laminated straps shall be made from tinned Copper sheets or Aluminium laminates depending on the clamp.
- v) Size of the terminals / connectors for which the clamp / connector is available, shall be embossed / punched (i.e. indelibly marked) on each component of the clamp / connector except on the Hardware.
- vi) Clamp shall be designed to carry the same current as that of the ACSR conductor and the temperature rise shall be equal or less than that of the conductor at the specified ambient temperature. The rated current for which the clamp / conductor is designed with reference to the specified reference ambient temperature, shall also be indelibly marked on each component of the clamp / connector, except on the hardware.
- vii) Connector design shall permit easy checking to ensure that the connector is installed correctly.
- viii) Bolted type of parallel connector design comprising the same run and tap stranded conductor material shall be made with a common base plate and a common cap.
- ix) Bolts shall have M10 or M12 thread. Tightening torque shall be 45Nm and 80Nm for M10 and M12 respectively.
- x) Clamps shall be designed such that the support insulators are not subjected to extra stresses by butt torsional action from the tubular conductor during vibration, wind, ice load and short circuits.

5.15.2

DESIGN

- i) Bolted type of connector shall be designed to withstand normal assembly stresses without suffering permanent deformation.
- ii) Connectors shall be designed to withstand stresses in service due to wind, ice, vibrations, fluctuations in temperature and short-circuits, without suffering permanent deformation or breakages. In addition, connectors for bundled stranded conductors shall withstand short-circuit inertia forces.
- iii) Connector design shall be such that tensile, bending and wrenching stresses transmitted to the equipment terminals are minimum possible. Connectors shall



**PURCHASE SPECIFICATION FOR
DESIGN,SUPPLY, E&C AND O&M OF 66KV S/Y BAY AT
10MW, KPCL-BELAKAVADI,MANDYA**

PS-439-912

REV NO: 00

PAGE : 47 OF
64

- permit axial movement of the tubular conductor.
- iv) Parts of current carrying connectors which are in direct contact with the conductor shall be designed so that dangerous galvanic corrosion in the contact surface does not occur.
 - v) Current carrying connectors shall be designed so that hysteresis and eddy current losses are small.
 - vi) The shape of current carrying connectors shall be such that water collection is eliminated. If this is not possible, the connector shall be supplied with drainage holes of at least 6 mm.

5.16 PHASE PLATES, DANGER BOARDS AND PAINTING OF EQUIPMENT & ITS ACCESSORIES

The required number of phase plates for the bus conductor and line conductors, danger boards shall be provided and all the equipment terminals, bus posts shall be painted for phase identification as per the statutory requirement. The touch painting of equipment and its accessories shall be carried out wherever required.

5.17 GROUND MAT FOR SWITCH YARD

- i) The welded surface of the ground mat joints and cross connections of the earth mat grid shall be cleaned and two coats of red oxide paint and one coat of coal tar paint shall be applied after allowing each coat to dry sufficiently.
- ii) In addition, CI pipe rods shall be driven all-round the power house periphery at an interval of 6 mtrs. The CI pipe rods shall be interconnected to form a grid using GI flats. The rods shall be driven directly to the ground and filled with bentonite clay and connected to the ground mat.
- iii) The VENDOR shall carry out the study of soil resistivity after completion of erection and in case the soil resistivity is found to be high, then additional mat shall be laid and connected to the existing ground mat in the switchyard mat to bring down the resistance value below 0.5 Ohms.

5.18 SPARES

5.18.1 66 KV Breaker

- i) Spare pole with operating mechanism - 1 No.
- ii) Closing coil - 4 Nos
- iii) Tripping coil - 4 Nos
- iv) Spring charging motor for spring charging mechanism - 1 No.

- v) Gaskets & 'o' ring for one set of 3 pole breaker - 1 set
- vi) Gas filling unit comprising regulator with manometer and necessary coupling hose - 1 No.

for filling of SF6 gas.

	PURCHASE SPECIFICATION FOR	PS-439-912
	DESIGN,SUPPLY, E&C AND O&M OF 66KV S/Y BAY AT	REV NO: 00
	10MW, KPCL-BELAKAVADI,MANDYA	PAGE : 48 OF 64

5.18.2 66 KV Isolator

- | | | |
|------|------------------------|------------------|
| i) | Fixed contact assembly | - 6 Nos. (1 set) |
| ii) | Moving contact blade | - 3 Nos. (1 set) |
| iii) | Closing contactor | - 2 Nos. |
| iv) | Opening contactor | - 2 Nos. |
| v) | Operating motor | - 1 No. |
| vi) | Solid core insulators | - 9 Stacks(1set) |

5.18.3 11kv ISOLATOR

- | | | |
|----|---------------|----------|
| i) | Drop out fuse | - 3 nos. |
|----|---------------|----------|

5.19 CONTROL AND RELAY (PROTECTION) PANELS

5.19.1 SCOPE

This specification covers design, manufacture, inspection, testing at works supply, erection and commissioning of control and protection panels, annunciation equipment, and other miscellaneous equipment.

It is proposed to accommodate the duplex panels for control, metering & protection in the control room.

Rear side of duplex panels shall be complete with Numerical Protection relays, auxiliary relays, discrete relays, trip relays etc. required for the scheme.

Front side of the duplex panels shall be complete with Mimic Diagram, Micro processor based alarm & annunciation system, energy meters, indicating meters like MW meter, ammeters, volt meter, power factor meter, MVAR meter, Control switches and other miscellaneous equipments required for the scheme.

The equipment offered shall conform to latest standards of Engineering, design and workmanship in all respects. The equipment manufactured shall ensure satisfactory and reliable performance throughout the service life.

5.19.2 STANDARDS

The equipment covered by this specification shall unless otherwise specified, be built to conform to the latest editions of relevant Indian Standards, British or American or other equivalent standards. In the event of supplies as per other equivalent International standards, English translation of the same shall be furnished. Details of standards considered shall be mentioned in the offer.

5.19.3 AUXILIARY SUPPLY FOR RELAYS AND CONTROLS

The VENDOR shall design the equipments suitable for either auxiliary supply of 415 V, 3 Phase or 240V, 1 Phase, 50 Hz, AC or 110 V DC. The AC supply voltage is subject to a variation of ± 10 percent and frequency variation of - 5% to +3%. The DC supply is subject to a variation of plus or minus 10%. In the event of the VENDOR supplying equipment suitable for any other auxiliary supply

	PURCHASE SPECIFICATION FOR DESIGN,SUPPLY, E&C AND O&M OF 66KV S/Y BAY AT 10MW, KPCL-BELAKAVADI,MANDYA	PS-439-912
		REV NO: 00
		PAGE : 49 OF 64

voltage, the VENDOR shall include necessary auxiliary power conversion appliances.

Necessary fuse blocks, terminal blocks with shrouds etc., shall be provided for receiving the AC and /or DC control supply.

5.19.4 LAYOUT AND CONSTRUCTION OF PANEL

The panel shall be of duplex type. If any space constraints are there, then separate panels shall be provided for protection, control, metering & annunciation respectively which shall be finalized during detailed engineering.

The materials of panels shall be stretcher leveled steel plate of 10 SWG for front and rear panels, door frame and base frame and 14 SWG for side panels and doors.

The panels shall accommodate all the specified instruments and controls without overcrowding.

The complete panel shall be dust and vermin-proof and it shall be suitable for tropical use. All holes and extension windows in the panels shall be blanked and access doors shall be lined with compressible liners at the edges. Bottom cable entry openings shall be shut off with fiber sheet with holes left to accommodate the cables or alternatively removable gland plate of suitable dimension shall be provided.

5.19.5 FOUNDATION DETAILS

VENDOR shall supply the panels with base channel. Suitable foundation bolts, nuts, lock nuts, washers etc., shall also be supplied

5.19.6 PAINTING

Painting shall be carried out as per the "Standard Seven Tank" method with powder coating. The color of the panel shall be finalized during detailed engineering.

5.19.7 SMALL WIRING

All wiring shall be switch board type with stranded conductor tinned annealed copper wire provided with fire retardant low smoke insulation, which has proved its utility in tropical regions against hot and moist climate and vermin (mice, white ants & cockroaches etc.).

The sizes of wiring in different circuits shall not be less than those specified below:

5.19.8 MINIMUM PERMISSIBLE WIRE SIZE:

Circuit	Area of cross section of conductors
Metering and relaying circuits connected to instrument transformer circuits	PT - 4 Sq.mm copper CT - 6 Sq.mm copper

	PURCHASE SPECIFICATION FOR	PS-439-912
	DESIGN,SUPPLY, E&C AND O&M OF 66KV S/Y BAY AT	REV NO: 00
	10MW, KPCL-BELAKAVADI,MANDYA	PAGE : 50 OF 64

All Control circuits	Control - 2.5 Sq. mm copper
Indication, Annunciation & Signaling circuits	1.5 Sq.mm copper

Heavy wires shall be composed of strands of diameter not less than 1.25 mm. or equivalent.

5.19.9 The following colour scheme shall be used for the wiring:

Colour of wire	Circuit where used
Red	R phase of CT/PT circuit
Yellow	Y phase of CT/PT circuit
Blue	B phase of CT/PT circuit
Green	Neutral connections earthed or not earthed in CT/PT circuit
Black	AC control wiring circuit using 415/240V auxiliary, supply and cubicle lighting.
Grey or White	DC control wiring circuit using 110 V DC battery supply or lower voltages of DC supply

The colour of ferrules shall be white with black lettering. Alternatively suitable printed plastic sleeves shall be provided instead of discrete ferrules.

5.19.10 All cubicle wiring shall be of the grouped type laid out in flat formation on the framework, in interior of the panel / cubicles and secured to it by means of cleats. Wiring shall be run straight and given right angle bends wherever necessary. Wiring round the hinges shall be of extra flexible conductors, twisted around the axis of wires.

5.19.11 Wiring connected to the space heaters in the cubicle shall have porcelain-beaded insulation over a safe length from the heater terminals or alternatively shall have fiberglass insulation.

5.19.12 Terminal ends of all wires shall be provided with numbered ferrules for phase/lead number identification. At points of intersection where a change of number is necessary, duplicate ferrules shall be provided with the appropriate numbers on the changing end.

5.19.13 Wire ends shall be elegantly crimped with solder less lugs. At the terminal connection, washers shall be interposed between wire terminals and the holding nuts. All holding nuts shall be secured with locking nuts. The connection stud shall project at least 3 mm from the locknut surface. Scissor type lugs are prohibited. Only round lugs shall be employed.

5.19.14 **TERMINAL BLOCKS CONNECTION**

Disconnecting type Terminal block connectors of vertical pillar type built from cells of moulded dielectric and brass stud inserts shall be provided for terminating the outgoing ends of the cubicle wiring and the corresponding incoming tail ends of the control cables. Provision shall be made on each pillar for holding 20 percent extra connections. All blocks shall be shrouded by easily removable

	PURCHASE SPECIFICATION FOR	PS-439-912
	DESIGN,SUPPLY, E&C AND O&M OF 66KV S/Y BAY AT	REV NO: 00
	10MW, KPCL-BELAKAVADI,MANDYA	PAGE : 51 OF 64

shrouds, moulded of transparent dielectric material. The terminal blocks shall be suitable for 660 / 1100 volts service.

Terminals shall be numbered by suitable PVC inscriptions. These inscriptions shall be secured rigidly to the terminal block in the recess provided for them.

5.19.15 SPACE FOR CONTROL CABLES AND CABLE GLANDS

Sufficient space for receiving the control cables inside the switchboard at the bottom of the cubicles and mounting arrangement for the terminal cable glands shall be provided.

5.19.16 SPACE HEATERS

Space heaters suitable for connection to the single phase AC supply shall be provided at the bottom of the panel to prevent condensation of moisture. The watt loss per unit surface of heater shall be low enough to keep surface temperature well below visible heat. The space heater shall be so located that no equipment or wire is subjected to direct heating.

5.19.17 FUSES

Suitable HRC fuses shall be provided in all potential and AC / DC supply circuits. Fuse bases and carriers shall be mounted in the interior of the switch board cubicle at an easily accessible place. The fuse carrier and base shall have imprints of the fuse rating and the voltage rating. Fuses in PT circuits shall be provided with phase circuit labels.

20% of fuse links actually used shall be supplied as spares.

5.19.18 TEST BLOCKS

Suitable Test blocks with contacts rated for carrying 10 amps continuous and 150 amps for at least one second at 240 volts AC or 110V DC shall be provided, for the purpose of routine check & testing of relays and instruments. The current terminals shall be provided with links or other devices for shorting terminals of CT leads before interrupting the normal circuit for injection from an external source or for inserting testing instruments in the circuit without causing open circuit of the current transformer secondary. The potential testing studs shall preferably be housed in narrow recesses of the block moulding insulation, to prevent accidental short circuit across the studs. Test block covers shall be removable from the front of panel board and provided with suitable lead sealing arrangement to prevent unauthorized access to the test studs.

5.19.19 SAFETY EARTHING

Earthing of metallic bodies of the equipment and devices on the switchboard shall be done with soft drawn PVC insulated stranded conductor.

	PURCHASE SPECIFICATION FOR DESIGN,SUPPLY, E&C AND O&M OF 66KV S/Y BAY AT 10MW, KPCL-BELAKAVADI,MANDYA	PS-439-912
		REV NO: 00
		PAGE : 52 OF 64

5.19.20 **PANEL LIGHTING AND POWER OUTLETS**

The panel interior shall be illuminated by compact fluorescent lamps. The illumination of the wiring shall be free from hard shadows and shall be planned to avoid any strain or fatigue to the wireman likely to be caused due to abnormal or non-uniform illumination. These lights shall be operated by door operated push button switches.

At least two 5 amps two pin plug points and one no 15 amps 3 pin power plug outlets shall be provided at convenient points in each of the switch board assemblies.

5.19.21 **NAME AND IDENTITY PLATES**

All instruments, relays and such other similar electrical devices mounted on the control panel shall be provided with name plates bearing the manufacturer's name, serial number and the electrical rating data.

12 mm wide plastic plates bearing suitable identification marks, shall be fixed in the interior of the switchboard under the terminal wiring of back connected semi-flush mounted device on the switchboard, at the test blocks, at the fuse blocks and at the cable terminals. Similar plates shall be fixed on the exterior of the switchboard in appropriate places to indicate the functions of the control switches, push buttons and equipment numbers, etc. Equipments such as relays etc. shall be identified by ASA code numbers, the same numbers being used in the detailed wiring drawings for easy identification and tracing.

75 mm brass or plastic plates bearing suitable circuit description etched in 50 mm size letters and enamel filled, shall be provided for each circuit and mounted on the top of each panel. These plates shall be of removable type.

5.19.22 **CONTROL SWITCHES**

Control and instrument switches shall be rotary operated type with escutcheon plates clearly marked to show operating position and circuit designation plates and suitable for flush mounting with only switch front plate and operating handle projecting out.

The control switch of breaker and isolators shall be of spring return to neutral type. The spring return type shall be provided with lost motion device and minimum ten ways for CB control switch and four ways for isolator control switch.

5.19.23 **ALARM ANNUNCIATION SYSTEM at 66kV**

Microprocessor based annunciation system is to be provided and mounted at front side of duplex type relay panel. Description of faces for alarms will be finalized during detail engineering. Two different color windows for trip and non-trip alarms shall be provided. Required push buttons for accept, sound cancel, reset and lamp test shall also be provided. Ring back sequence shall be provided with a separate hooter. Alarm annunciation system for 66kV system shall be hooked to SCADA. A separate annunciation panel is not envisaged.

	PURCHASE SPECIFICATION FOR	PS-439-912
	DESIGN,SUPPLY, E&C AND O&M OF 66KV S/Y BAY AT	REV NO: 00
	10MW, KPCL-BELAKAVADI,MANDYA	PAGE : 53 OF 64

5.19.24 PROTECTION REQUIREMENT

(a) GENERAL

The bidder shall furnish scheme drawing including accessories like CTs, VTs and all other necessary devices required for the satisfactory performance of the relay & protection scheme.

(b) SPECIFICATION OF PROTECTION SYSTEM FOR TRANSFORMER:

The Protection panel is to be provided with the following:

1. One number of Numerical integrated multi-functional Transformer protection Relay providing the following Protection Functions/ features.
2. Transformer differential protection suitable for two winding (87T)
3. Restricted earth fault protection for HV winding of transformer (64 REF)
4. Following auxiliary functions shall be provided by utilizing built-in relays or separate auxiliary relays with targets and of hand reset type.
 - a. Transformer Bucholz - Alarm
 - b. Transformer Bucholz - Trip
 - c. Transformer pressure relief - Alarm
 - d. Transformer pressure relief - Trip
 - e. Transformer winding temperature High - Alarm
 - f. Transformer winding temperature Very high - Trip
 - g. Transformer oil temperature High - Alarm
 - h. Transformer oil temperature Very high - Trip
 - i. Low oil level in transformer - Alarm
 - j. Very low level in transformer - Trip
5. Trip circuit supervision relay for monitoring pre and post Close trip circuit supervision for both trip circuits 1& 2 of 66 KV breakers - 195/295
6. High - speed trip relay with electrical reset with trip coil supervision - 86
7. Contact multiplication relays for circuit breakers & isolators having sufficient no. of NO & NC contacts.
8. DC supervision relay for DC supervision.
9. Test Blocks for Secondary injection testing for each type of relay.
10. The following protection shall be provided as back up:
 - (a) Over current and Earth fault Protection with high set instantaneous feature for transformer -51/50/51N - **GTA, B, C**
 - (b) Earth fault protection with high set instantaneous feature for transformer - 51 GTN

The above relays shall be numerical relays only and shall have communication facilities.

Note: Protection features indicated above is for minimum requirement. Vendor shall incorporate any additional requirements in this regard as per the design to be submitted at the time of the bid. Details of the design shall be furnished.

	PURCHASE SPECIFICATION FOR	PS-439-912
	DESIGN,SUPPLY, E&C AND O&M OF 66KV S/Y BAY AT	REV NO: 00
	10MW, KPCL-BELAKAVADI,MANDYA	PAGE : 54 OF 64

5.19.25

FEATURES TO BE PROVIDED IN NUMERICAL RELAYS

Numerical relays shall have following features apart from the protection functions described above.

i) Measurement functions

The relay shall provide measurement of all analog input quantities and derived quantities. The measured values shall be displayed in the Local MMI & Remote PC monitor when such measurement is selected by the user.

ii) Self-Monitoring:

The continuous self-monitoring feature shall enable the protection system to recognize any defective unit immediately. Power on diagnostic test shall include checks on the time, microprocessor, memory and the analog input module.

iii) Event and Fault Recording:

Event records shall be stored in non-volatile memory. Event records shall be generated whenever there is a protection function operation, energization of a status input, operation of an output relay or any hardware failure.

Fault records shall be initiated when user selected relay output operate. The record shall consist of the date and time of the fault, the state of binary inputs, relay outputs and protection functions, together with the measured values during the fault. Sufficient recording of events / faults shall be available for detailed analysis.

iv) Time Synchronizing:

The relay shall have time synchronizing facility for synchronizing the time.

v) Communication:

The system shall be capable of communicating both locally and remotely. The communication shall be on open Protocol / IEC 61850 Protocol and the same shall be finalized during detailed engineering. It shall be possible to program all settings off-line and on-line and to down load same subsequently to the system from compact disc / diskettes or via the network-control communication line.

Parameters, signals, measured values as well as remote parameter setting commands shall be exchanged via appropriate interfaces and communication established with the centralized remote PC.

vi) Programmable scheme logic:

The protection system shall be provided with built in programmable scheme logics. Additional provisions shall be given for the logic to take signals from external functions and group them like the internal functions.

	PURCHASE SPECIFICATION FOR DESIGN, SUPPLY, E&C AND O&M OF 66KV S/Y BAY AT 10MW, KPCL-BELAKAVADI, MANDYA	PS-439-912
		REV NO: 00
		PAGE : 55 OF 64

- vii) Definable access codes**
User definable access codes for providing security to settings and changes in configuration or changes of parameter values shall only be permitted after a password is entered.
- viii) Human Machine Interface:**
The relay shall have necessary keys and LCD on their front panel for an alphanumeric display. It should have a menu based structured interface to set / list parameters, read events, display measured values etc.
- ix) Electro-Magnetic Compatibility and isolation:**
The system shall be immune against electromagnetic interference. The design shall ensure physical separation of the interfaces from the signal processing units.

5.19.26 TESTS AT WORKS AND SITE

i) TESTS AT WORKS

The following routine tests shall be carried out on the panels at the firm's works:

- a) Checking of overall dimension, General arrangement, thickness of panel sheet, paint shade & paint thickness & adhesive test on sample panel
- b) Checking wiring, termination & continuity of circuits
- c) One minute HV withstand test of all equipments, panels & internal wiring shall be tested to withstand 2KV of power frequency to earth.
- d) Insulation resistance of complete wiring circuit with all equipments on panel before & after HV test.
- e) AC/DC scheme check as per approved schematics.
- f) Operational check of all protection functions in all relays by secondary voltage & current injection (in at least one set value) to check that values are within permissible limits. This shall include impedance, bias, directional check etc.
- g) The accuracy of measured values in Numerical relay display.
- h) Check of communication through front port of all numerical relays to PC and direct printer.
- i) Check of communication through rear port by connecting all numerical relays to PC. Viewing / Printing of relay data, setting data, logic configuration, events, faults & disturbance wave forms to be demonstrated.
- j) Type test certificates shall be furnished for the relays.
- k) Demonstration of Time Synchronization.
- l) Checking DI, DO & AI by simulation of signals.
- m) Functional check of hardware & software logics pertaining to control of 66 kV switchyard equipments.
- n) All routine & acceptance tests shall be conducted in the presence of BHEL/KPCL's representative.

	PURCHASE SPECIFICATION FOR	PS-439-912
	DESIGN,SUPPLY, E&C AND O&M OF 66KV S/Y BAY AT	REV NO: 00
	10MW, KPCL-BELAKAVADI,MANDYA	PAGE : 56 OF 64

ii) **TESTS AT SITE**

The following routine tests shall be carried out on the panels at site:-

- a) Checking of inter connection of relay panel to external equipment.
- b) Correctness of ratio & polarity of CT & PT.
- c) Secondary injection test from individual CT's & PT junction boxes to ascertain the correctness of wiring.
- d) DC logic tests as per the scheme.
- e) Checking of Annunciations
- f) Checking of 66 KV Breaker through relays of protection.
- g) Operational check of all protection functions in all relays by secondary voltage & current injection.
- h) Sensitivity & stability of relays shall be checked during short circuit test & open circuit test.
- i) Demonstration of control & monitoring of 66 KV switchyard equipments from touch panel provided on the panel and central computer system (SCADA).

Note: All the necessary test kits / test equipment are to be brought by the successful bidder to conduct all the above tests.

5.19.27 SPARES FOR C&R PANEL

- i) Numerical integrated multifunctional Transformer protection relay - 1 No.
- ii) Numerical O/C & E/F transformer – protection relay - 1 No.
- iii) Numerical E/F transformer protection relay - 1 No.
- iv) High speed trip relay - 1 No.
- v) Breaker trip coil supervision relay - 1 Set
- vi) High speed trip relay coil supervision relay - 1 Set
- vii) Auxiliary relay - 1 each type
- viii) Contact multiplication relay for Breaker and Isolator - 1 each type

5.20 METERING PANEL

- (a) The metering panel shall consist of two numbers of three phase 4 wire energy meters as main & check along with necessary test terminal boards (TTB's) to facilitate CT & PT connections shall be provided to measure the energy transmitted via the 66 kV line.
- (b) The panel shall be double door type with concealed type hinges (welded from inside) with viewing glass windows of suitable size to read energy meter readings.
- (c) Suitable MS channels shall be provided for panel support.

	PURCHASE SPECIFICATION FOR DESIGN,SUPPLY, E&C AND O&M OF 66KV S/Y BAY AT 10MW, KPCL-BELAKAVADI,MANDYA	PS-439-912
		REV NO: 00
		PAGE : 57 OF 64

- (d) Suitable lifting hooks shall be provided for lifting and movement of the panel.
- (e) The panel shall have painted (powder coated) finish with grey colour as per RAL 703.
- (f) The energy meters supplied shall be of microprocessor based trivector meter, conforming to IEC 60687 / IEC 62052 – 11 / IEC 62053-22 / IS 14697. The energy meter shall measure, record and display energy related parameters like MW, MVA, MVAR, MWH (Import), MWH (Export), MVARH (while active import) and MVARH (while active export) and Reactive MVARh net for voltage low condition & maximum demand of active import & Active export, reactive lag while active import, apparent while active import & Apparent while active export.
- (g) In addition, instantaneous phase parameters like voltage, current and power factor are also to be recorded.
- (h) The accuracy class of energy meter shall be 0.2.
- (i) The energy meter shall be suitable for the measurement of alternating current electrical energy of frequency in the range of 47.5 Hz to 52.5 HZ (Nominal frequency 50 Hz) for three phase, 110V System and 1A/5A Secondary of CT. The limits of errors shall be as per IS 14697.
- (j) The meter shall be suitable for balanced or unbalanced loads and work at all power factors.
- (k) The CT and PT ratios shall be programmable. Utility for changing the ratios at site shall be provided.
- (l) It shall be possible to couple this device to meter testing equipment.
- (m) Voltage healthiness in all the phases shall be provided suitably on the meter display in the form of phase blinkers.
- (n) Meters shall have a distinct code which shall be marked permanently on its front, as well as in its memory.
- (o) The meter shall have an alphanumeric LCD display of minimum 7 digits.
- (p) The meters shall have a suitable communication port for communication with the SCADA system.
- (q) The meter shall be capable of storing 15 minutes data (load survey data) for at least 35 days.

	PURCHASE SPECIFICATION FOR DESIGN,SUPPLY, E&C AND O&M OF 66KV S/Y BAY AT 10MW, KPCL-BELAKAVADI,MANDYA	PS-439-912
		REV NO: 00
		PAGE : 58 OF 64

5.21 LIGHTNING PROTECTION WITH SHIELD WIRE:

Vendor to provide lightning protection with shield wire for the entire 66kv switchyard bay.

5.22 DRAWINGS AND LITERATURE

Vendor shall furnish the detailed literature about protection system. General arrangement and foundation details of panels, detailed literatures with maintenance & commissioning instructions of relays, control switches, single line diagrams, wiring diagrams, wire wise schedules and scheme drawings shall be furnished on materialization of contract for approval. 5 sets of drawings and literatures with wiring drawings, dimensions and mounting details shall be supplied. All the drawing shall be in A3 size with clear visibility duly spiral binding.

6.0 COMPREHENSIVE OPERATION & MAINTENANCE (O&M)

6.1 DETAILS OF O&M

The vendor shall operate and maintain the 66kv switchyard (including 12.5MVA transformer) associated with the 10MW Solar power plant for a period of 3 years from the date of commissioning.

- (a) Zero date of operation shall begin on the date of actual commissioning of the complete 10MWp Power Plant and grid connection to the 66kV feeder.
- (b) Operation work includes day-to-day operation and maintenance of all switchyard equipments and civil works .
- (c) The vendor shall furnish necessary details regarding technical competence, qualification and number of different grades of personnel to be posted at the switchyard along with proposed maintenance (preventive) schedule. The maintenance personnel shall be qualified, appropriately certified and well trained so that they can handle any type of operational problems quickly and timely.
- (d) The maintenance staff of the vendor shall be available in the Power Plant for every day irrespective of whether the plant is in operation or not unless otherwise instructed by the BHEL/ BHEL customer in writing.

6.2 SCOPE OF OPERATION OF THE 66kv SWITCHYARD:

- (a) The maintenance personnel shall be in a position to check and test all the equipment regularly, so that, preventive maintenance could be taken well in advance to save any equipment from damage. Any abnormal behavior of any equipment shall be brought to the notice of BHEL contact person immediately.
- (b) All repairing & replacement works are to be completed by the vendor within 24 hours from the time of occurrence of fault or defect. If it is not possible to set right the equipment within this time, the vendor shall notify the BHEL/ BHEL CUSTOMER indicating nature of fault & cause of damage etc within 12 hours from the time of occurrence of the fault.
- (c) If there is any loss or damage of any component of the switchyard due to mismanagement / mishandling or due to any other reasons, the vendor shall be responsible for immediate replacement / rectification. The damaged component may be repaired, if it is understood that performance of the components is regained upon repairing. Otherwise, the defective

	PURCHASE SPECIFICATION FOR DESIGN,SUPPLY, E&C AND O&M OF 66KV S/Y BAY AT 10MW, KPCL-BELAKAVADI,MANDYA	PS-439-912
		REV NO: 00
		PAGE : 59 OF 64

components shall have to be replaced by new one without any extra cost, for the items supplied by the vendor. For the items supplied by BHEL, necessary spares will be kept at site which has to be stored properly by the vendor.

6.3 SCOPE OF MAINTENANCE WORK

- (a) Monitor and ensure the regular operation of switchyard equipments ensuring that power is fed to the 66 KV feeder.
- (b) Recording data of power exported daily as per the format given by BHEL. The vendor shall keep a record Book in this respect clearly indicating date and time of monitoring/inspection and comments for action etc.
- (c) Keeping & recording daily log sheet as per approved format to be supplied after commissioning of the power plant.
- (d) Tightening of all electrical connections, line accessories, transformers and associated switch gear in the switchyard.
- (e) Under no circumstances, the operator shall operate the switchyard by damaging the substation grid.
- (f) Vendor's employees shall use no part of the switchyard premises for residential or any other purpose except for running the plant.
- (g) Vendor shall submit monthly performance report indicating cumulative energy generation data as per approved format within 15 days of the following month. The vendor shall preserve all recorded data both in hard copy and soft copy and shall submit to BHEL quarterly.
- (h) During maintenance period, the vendor shall refill the Fire Extinguisher as per manufacturer's recommendation before expiry.
- (i) Vendor shall carry out periodic maintenance of all the equipment such as transformer oil filtration, breaker maintenance etc as per statutory regulations and manufacturers recommendations.

6.4 SCOPE OF CIVIL MAINTENANCE

- (a) Cleaning & maintaining switch-yard area.
- (b) Maintenance (including painting) of all structures associated with the switchyard as and when required as per instruction of Engineer-in-charge.

6.5 GENERAL INSTRUCTIONS

- (a) Vendor's representatives/ employees shall conform to general regulations in force at site and to any special instructions from local administration issued by BHEL Customer. All employees of vendor at site shall be deemed to be aware of damages and risks incidental to conditions of BHEL land & works from time to time and BHEL shall not be responsible for any injury arising there from.
- (b) BHEL/ BHEL customer reserve their right to ask the vendor to remove / transfer any staff of the vendor from site without assigning any reason whatsoever. Instructions issued in writing

	PURCHASE SPECIFICATION FOR	PS-439-912
	DESIGN,SUPPLY, E&C AND O&M OF 66KV S/Y BAY AT	REV NO: 00
	10MW, KPCL-BELAKAVADI,MANDYA	PAGE : 60 OF 64

to the vendor in this matter shall be binding and the vendor shall replace the transferred / removed person with a suitable replacement immediately.

- (c) The vendor shall supply raincoats, toolset, gloves, gumboots, helmet and other items required for carrying out the services.
- (d) BHEL/ BHEL Customer shall have power to disallow any personnel, if found unsuitable. Vendor shall have to replace such persons.
- (e) Vendor shall maintain attendance register for all their staff deployed for carrying out jobs on regular basis. Vendor shall take care of statutory requirements such as ESI and PF for their employees posted at site.

7.0 TEST CERTIFICATES OF VENDOR-SUPPLIED ITEMS / BHEL APPROVAL PRIOR TO DISPATCH

- (a) Vendor shall confirm in their offer that test certificates / test report shall be furnished for all items supplied by them.
 - 1) Cables – All the types that are supplied by vendor
 - 2) Lightning arrestors / surge suppressors used in 66kV switchyard
 - 3) Gang operated switch – 11kV air-break-switch
 - 4) Earthing electrodes / kits
 - 5) 66kV switchyard equipment
 - (i) 72.5 kV SF6 switchgear
 - (ii) 72.5 kV isolator, earth switch, motor operated
 - (iii) 72.5 kV current transformers
 - (iv) 72.5 kV potential transformers
 - (v) Marshalling boxes
 - (vi) 60kV lightning arrestors
 - (vii) Relays, meters, switches used in C&R panel
 - (viii) Energy meters used in the metering panel
 - (ix) Steel mounting structures and towers
 - (x) ACSR conductors
 - (xi) Insulators
- (b) The above items shall be dispatched to the site only after submission of test certificates to BHEL and obtaining approval from BHEL / BHEL customer.

8.0 GENERAL TERMS AND CONDITIONS

- (a) Being an EPC contractor, vendor shall furnish all the design basis/details along with schemes, drawings, BOM etc. Vendor shall also liaise with CEIG to obtain necessary permissions /clearances.
- (b) Responsibility, right and liabilities of the vendor, under this contract, will commence from the date of acceptance of the purchase order.
- (c) The work will have to be carried out in such a manner that will not cause any inconvenience to other agencies working in the site.
- (d) After completion of the work, the entire site / area will be cleaned off debris etc.

	PURCHASE SPECIFICATION FOR DESIGN,SUPPLY, E&C AND O&M OF 66KV S/Y BAY AT 10MW, KPCL-BELAKAVADI,MANDYA	PS-439-912
		REV NO: 00
		PAGE : 61 OF 64

- (e) All the materials brought to site shall accompany with appropriate paper work like DC, Invoice etc. duly verified & signed by BHEL / BHEL Customer, to be submitted to BHEL for payment.
- (f) Any damage to the buildings / structures / area made by vendor's workmen or by vendor's agent will be made good by vendor at their cost.
- (g) Safety of vendor's workmen or vendor's agent is responsibility of the vendor. Accordingly, risk and necessary insurance and safety cover shall be addressed by vendor.
- (h) No child labour should be employed for executing the contract.
- (i) In case work is not completed as per BHEL scope due to reasons arising out of delayed material supply from BHEL end / vendor's end, vendor has to complete the job at later stage without any extra charges. No overrun charges shall be paid in case of extension of work schedules. Any miscellaneous materials that have not been mentioned specifically in the specification / tender which are required for I&C of the switchyard shall be deemed to be included in the specification and shall be supplied by the vendor without any extra charges.
- (j) Vendor is required to meet all the statutory obligation with regard to work deployed by vendor for the contract such as ESI, PF, Minimum wage act ,Work man compensation act, Income Tax act, Employees Insurance act etc.
- (k) All tools and tackles required for installation, wiring, assembly, digging of cable trenches, earth pits etc have to be organized by the vendor. All the accessories such as power drilling machine, cutting machine, digging tools & complete set of crimping tools etc have to be organized by vendor.
- (l) All the works shall be executed strictly as per the direction of BHEL engineer at site.

9.0 DOCUMENTS TO BE FURNISHED ALONG WITH OFFER

- (a) Clause-wise acceptance list, bringing out remarks and deviations wherever applicable.
- (b) Bar chart indicating the "activity – time schedule" of implementation of the project, indicating the time taken for major identified activities from the date of issuance of Purchase order (including handing over of site).
- (c) Declaration of following particulars:
 - 1) List of machinery, with quantity, proposed to be employed at the site for various activities such as excavation, foundation, cable trench formation, earth mat construction, material / equipment movement and positioning, etc.
 - 2) List of tools and tackles, with quantity, proposed to be employed at the site
 - 3) List of measuring instruments, proposed to be employed at the site.
 - 4) Manpower proposed viz-a-viz major activities, stage-wise.
- (d) Drawing and bill of materials for 66kV switchyard layout.

10.0 DOCUMENTS TO BE FURNISHED AFTER RECEIPT OF PURCHASE ORDER FOR BHEL / BHEL CUSTOMER APPROVAL

Vendor shall furnish the following documents to BHEL / BHEL customer, in phased manner, after receipt of purchase order for approval.

	PURCHASE SPECIFICATION FOR DESIGN,SUPPLY, E&C AND O&M OF 66KV S/Y BAY AT 10MW, KPCL-BELAKAVADI,MANDYA	PS-439-912
		REV NO: 00
		PAGE : 62 OF 64

- (a) Catalogues, part numbers, datasheets and operation manuals of the items supplied by vendor.
- (b) Drawings of cable trenches in switchyards.
- (c) Drawings of foundation pedestals to mount electrical equipment such as transformers, panels, etc.
- (d) Drawings of earthing arrangements in 66kV switchyard.
- (e) General arrangement and layout drawings of 66kV switchyard, with dimensions and BoM.
- (f) General arrangement and detailed circuit / wiring drawings of C&R panel of 66kV switchyard.
- (g) General arrangement and detailed circuit / wiring drawings of Metering panel of 66kV switchyard.
- (h) Interlocking arrangement employed.
- (i) Drawings of mounting structures.
- (j) Type approval certificate shall be provided by the vendor wherever IP ratings are asked for.

Note: Wherever required, section views shall be included to show the finer details and dimensions.

11.0 O&M AND SAFETY MANUALS

Vendor shall submit O&M and safety manuals (6 copies) to BHEL / BHEL customer after the commissioning of the plant and prior to the commencement of O&M period.

- (a) Operation and maintenance manual, showing various operation and maintenance procedures (tests, checks, methods, recording formats, etc.) issued for three years of O&M.
- (b) Safety instructions as issued to their operating and maintenance staff, to be followed and implemented during the three years of O&M.

	PURCHASE SPECIFICATION FOR	PS-439-912
	DESIGN,SUPPLY, E&C AND O&M OF 66KV S/Y BAY AT	REV NO: 00
	10MW, KPCL-BELAKAVADI,MANDYA	PAGE : 63 OF 64

12.0 LIST OF PROPOSED MAKE FOR 66KV SWITCHYARD EQUIPMENTS

SI no	EQUIPMENT/MATERIALS	PROPOSED MAKES
1	12KV AND 72.5KV ISOLATOR	GR Power(Hyderabad)/Hivelm(Chennai) / S&S Power(Pondicherry) / Switchgear & Structural / G.K. Electricals / Siemens /Electrolite(Jaipur)/CGL(Mumbai).
2	72.5kV CIRCUIT BREAKER	Siemens(Mumbai)/ABB(Nashik)/ABB(Vadodara)/CGL(Nashik)/ BHEL(Hyderabad)/Alstom(Kanchipuram)/Schneider(Hyderabad) L&T(Chennai).
3	72.5kV CURRENT TRANSFORMER	Mehru(Bhiwadi) /Kalpa(Bangalore)/ Kappa(Chennai) / Pragati (Mumbai).
4	72.5kV POTENTIAL TRANSFORMER	Mehru(Bhiwadi) /Kalpa(Bangalore)/ Kappa(Chennai) / Pragati (Mumbai).
5	60KV AND 9KV LIGHTNING ARRESTORS	Oblum (Hyderabad)/ CGL(Nashik) / Lamco(Hyderabad) / Electrolite(Jaipur).
6	ACSR Conductors	Smita(Ghaziabad)/Gupta Power Infra(Bhubaneshwar)/Saravathi(Bangalore)/Galaxy(Sangli)/ Hindustan Vidyut Products(Faridabad)/APAR(Vadodara/Silvassa)/Hira Cables(Hirakud)/JSK(Silvassa)/Cabcon(Kolkata).
7	Clamps & Connectors	Klemmen Engg(Chennai)/Milind(Mumbai)/EMI(Mumbai)/Nootan Engg(Mumbai)/Vinayak Transmission(Mumbai)/Tag Corporation(Chennai)/ITPL(Mumbai)/Mega engg(Chennai)/Rashtra Udyog(Kolkata)/PEE VEE ENGG(Bangalore).
8	LT Power & Control Cables	Polycab(Daman) / Universal cables(Satna) /Torrent cables(Nadiad) /Havells(Bhiwadi)/Cords Cable(Bhiwadi) / KEI (Bhiwadi)/ NICCO(Kolkata)/HVPL(Faridabad)/Paramount(Kurukshetra)/ Deltan Cables (Faridabad).
9	Switchyard Structures	Vatco/BM Engineers/Baroda Electro Engg Products/H.B Engineers/Advance Steel Tubes/Goodluck steel/APS/
10	Insulator Strings & Hardwares	Bikaner/Aditya Birla Insulators(Rishra)/Insulators & Electricals Company(Bhopal)/WSI(Chennai)/BHEL(Bangalore)/Modern Insulator(Abu Insulator)/Saravana Global Energy(Cuddalore)
11	Cable Trays	MJ Engg(Okhla)/Jamna Metals(Delhi)/Indiana Gratings(Pune)/AV Engg(Calcutta)/Vatco(Mumbai)/Inar

	PURCHASE SPECIFICATION FOR DESIGN,SUPPLY, E&C AND O&M OF 66KV S/Y BAY AT 10MW, KPCL-BELAKAVADI,MANDYA	PS-439-912
		REV NO: 00
		PAGE : 64 OF 64

		Profiles(Vishakapatnam)
12	Safety Items	Universal Energy Systems/ Thadhani / Kanex / Equivalent
13	LT Cable Termination, Glands, Lugs etc	Dowell(Mumbai)/3D(Umbergaon)/Chetna(Nasik)/Sunil & co(Calcutta)/Comet(Mumbai)/Quality Precision(Calcutta)/Anup Engg(Calcutta)/Standard Metal Industries(Mumbai).
14	Earthing Material	REPUTED MAKE
15	Bay Marshalling Kiosk & Junction Box	C&S(Noida)/Jasper(Noida)/Jakson(G Noida)/Pyrotech(Udaipur)/Saravana switchgear(Bangalore)/Avaid's Technovators(Gurgaon)

Note:

1. If the vendor intends to source the equipment(s) from manufacturers not mentioned in the above table, approval of BHEL needs to be taken prior to placing the PO.
2. Contractor shall furnish the details of the vendor (for the above items) who have successfully supplied such of those items and must have been working satisfactorily for at least ONE year at the site from the date of commissioning. End user certificate shall be furnished as evidence to BHEL.

DRG. No. 3-679-05-00737

This drawing is tentative and for tender purpose only.

66 KV BAY AT SFC

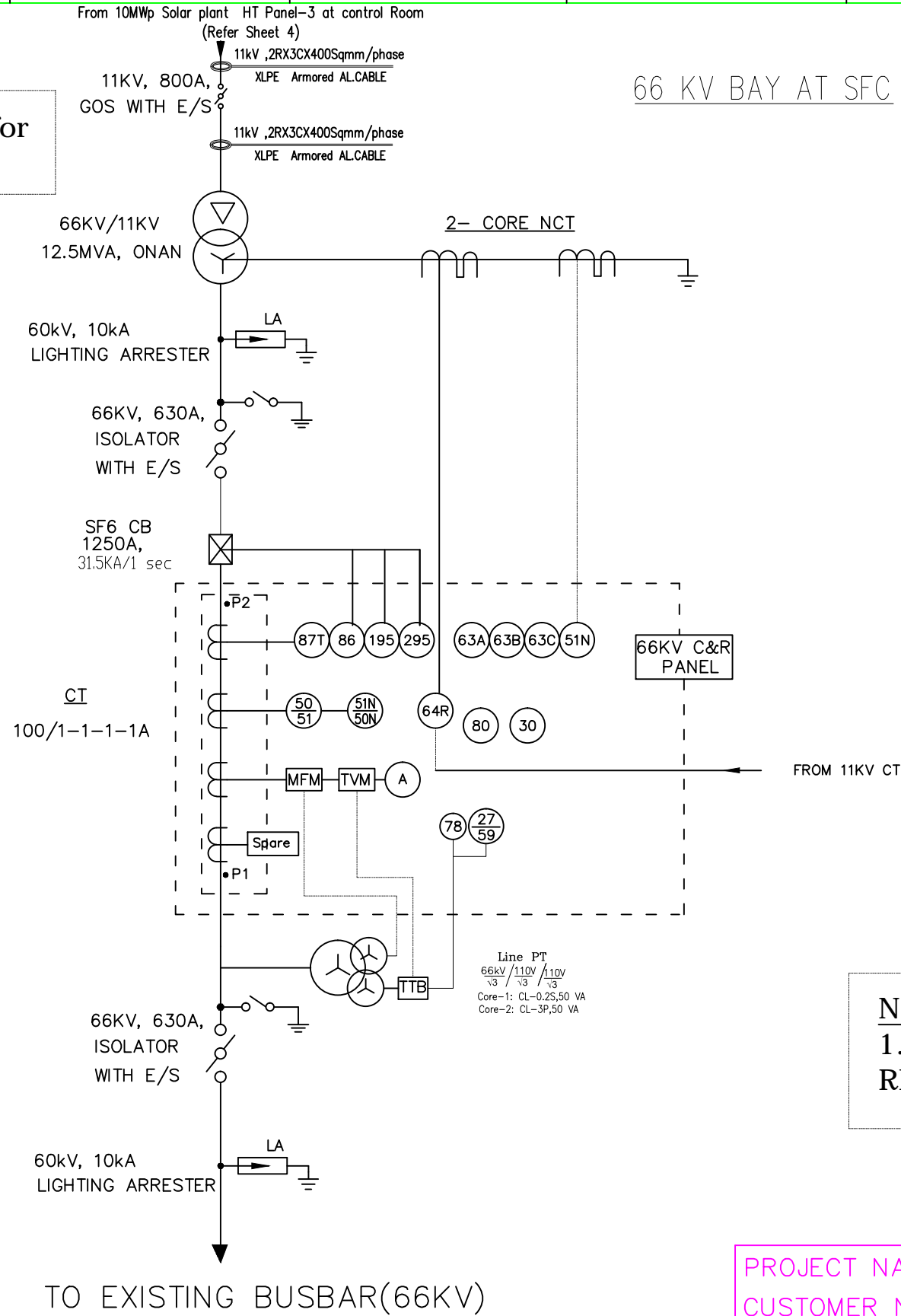

LEGEND:

- POWER TRANSFORMER
- LIGHTNING ARRESTER
- ISOLATOR WITH EARTH SWITCH
- SF6 CIRCUIT BREAKER
- AMMETER
- TRANSFORMER DIFFERENTIAL RELAY
- MASTER TRIP RELAY
- TRIP CIRCUIT SUP RELAY
- BUCHHOLTZ RELAY
- WTI & OTI
- INST. OVER CURRENT RELAY
- IDMT. OVER CURRENT RELAY
- INST. EARTH FAULT RELAY
- IDMT EARTH FAULT RELAY
- PHASE-ANGLE MEASURING RELAY
- UNDER VOLTAGE RELAY
- OVER VOLTAGE RELAY
- DC SUPERVISION RELAY
- ANNUNCIATOR RELAY
- TRI VECTOR METER

Note:
1. COMMUNICATION PROTOCOL OF NUMERICAL RELAYS SHALL BE AS PER IEC 61850.

PROJECT NAME : 10 MWp Solar PV Project, Mandya
CUSTOMER NAME : KPCL

BHARAT HEAVY ELECTRICALS LIMITED.
ELECTRONICS DIVISION, BANGALORE

REV.	DATE	ALTERED	REV.	DATE	ALTERED	NAME	SIGN	DATE
		CHECKED			CHECKED			
		APPROVED			APPROVED			
						DRAWN	ANJ	
						CHECKED	LNK	
						APPROVED	SLR	

BHARAT HEAVY ELECTRICALS LIMITED.

DEPT. CODE

TITLE:

AC SINGLE LINE DIAGRAM OF 10 MWp SPV PLANT		No. OF SHEETS	5
		SHEET No.	5
WBS. No.	DRG. No.	REV	
	3-679-05-00737	00	

COPYRIGHT AND CONFIDENTIAL
THE INFORMATION ON THIS DOCUMENT IS THE PROPERTY OF BHARAT HEAVY ELECTRICALS LTD. IT MUST NOT BE USED DIRECTLY OR INDIRECTLY IN ANY WAY DETRIMENTAL TO THE INTEREST OF THE COMPANY.

REF. DRG. No.

SIGN. & DATE

INVENTORY No.

COMMERCIAL TERMS & CONDITIONS (to be enclosed with TECHNO-COMMERCIAL BID) (For Indigenous Purchase Orders)				
RFQ No.HBSBOS016 RFQ DATE : 17.09.2014 DUE DATE : 10.10.2014				
Sl No.	Terms	BHEL Term	Confirmation	Deviation / Remarks
1	Bidding	(a) Bid has to be submitted as Two Part – in two sealed covers- Techno Commercial Bid(Part-1) & Price Bid (Part-II)- clearly written on each cover both put in a single sealed envelope super-scribed with RFQ No. and Due date.	Acceptable / Not acceptable	
		(b) Documents as called in Pre-Qualification Criteria (Clause 1.2 of PS-439-912) to be submitted along with technical bid(Part-1).	Acceptable / Not acceptable	
		(c) Annexures-B & B1 to be submitted along with technical bid (Part-1) & Annexure-B2 to be submitted along with Price bid (Part-II).	Acceptable / Not acceptable	
		(d) Clause-wise compliance to BHEL Purchase specification along with all documents as called in Technical specification to be submitted along with technical bid(Part-1).	Acceptable / Not acceptable	
2	Price Basis	Firm i.e., from the date of PO to completion of supply if I&C is not applicable. If I&C is in supplier's scope, then the prices shall remain Firm till commissioning & handing-over of the complete system. (PVC clause not acceptable).	Acceptable / Not acceptable	
3	Terms of Delivery	Free On Road Basis to Project site :Mandya	Acceptable / Not acceptable	
4	Delivery Period	(a) Supply : Completion within thirteen (13) weeks from the date of Drawing Approval. Drawing Submission : Progressively from one week from PO date	Acceptable / Not acceptable	
		(b) E&C : Completion within six (6) weeks from supply date.	Acceptable / Not acceptable	
5	Payment Term	(a) Supply : Payment of 80% basic Supply value + 100% Taxes shall be made with 45 days credit from the date of receipt of material at site. 10% on completion of I&C and certification line item wise on pro-rata basis. Balance 10% on execution of PBG valid for warranty period + 6 months claim period from any of the BHEL Consortium banks.	Acceptable / Not acceptable	
		(b) E&C: 90% on completion of I&C and certification line item wise on pro-rata basis. Balance 10% on execution of PBG valid for warranty/guarantee period + 6 months claim period from any of the BHEL Consortium banks.	Acceptable / Not acceptable	
		(c) O&M: 100% O&M charges are payable on quarterly basis against report certified by BHEL	Acceptable / Not acceptable	
		(d) For any other deviation loading will be done as per clause 25(A) of Enquiry - General Terms & Conditions (Ref : SCPV/BOS/01-Rev 00)	Acceptable / Not acceptable	
6	Excise Duty	(a) To confirm whether applicable. If applicable, indicate prevailing rate of Excise duty.	Applicable / Not applicable	Prevailing rate of Excise duty : %
		(b) BHEL is trying to avail Customs Duty & Excise duty exemption. Successful bidder shall support with all relevant documents.	Acceptable / Not acceptable	
7	Sales Tax	(a) To confirm whether applicable. If applicable, indicate prevailing rate of Sales Tax against Form c.	Applicable / Not applicable	Prevailing rate of Sales Tax against Form c: %
		(b) For issue of form "C", vendor has to furnish "E1/E2" form. Please confirm that "E1/E2 Sale form" will be submitted.	Acceptable / Not acceptable	
		(c) Wherever E1/E2 transactions are made, CST paid by sub vendor will not be reimbursed (As it is input cost to vendor)	Acceptable / Not acceptable	
8	Value Added Tax	Since it is inter-state movement of goods, VAT is not applicable. Only CST against form C is applicable.	Applicable / Not applicable	CST applicable @.....%
		OR Both are in the same State, VAT is applicable please indicate VAT applicable.	Applicable / Not applicable	VAT applicable @.....%
9	Octroi	To confirm whether applicable, if applicable indicate current rate of Octroi.	Applicable / Not applicable	Octroi.....%
10	Service Tax	To confirm whether applicable, if applicable indicate current rate of Service Tax. Furnish Service Tax Regn. No. Confirmation that Service Tax register is maintained.	Applicable / Not applicable	Service Tax.....% Service Tax Regn. No. S.Tax Register maintained : Yes/No

COMMERCIAL TERMS & CONDITIONS (to be enclosed with TECHNO-COMMERCIAL BID) (For Indigenous Purchase Orders)				
RFQ No.HBSBOS016 RFQ DATE : 17.09.2014 DUE DATE : 10.10.2014				
SI No.	Terms	BHEL Term	Confirmation	Deviation / Remarks
11	Freight	Freight charges shall be included in unit rate quoted(since it is on FOR basis to site).	Acceptable / Not acceptable	
12	Insurance	Transit insurance is in vendor scope in addition to the insurance as per Clause 3.4 of PS-439-912. Insurance charges shall be included in the unit rate quoted.	Acceptable / Not acceptable	
13	Evaluation of L1 vendor	(a) Over all L1 of Supply + I&C + O&M on "FOR" basis to site will only be considered.	BHEL	
		The percentage of Supply, Civil works and I&C values shall be in the range indicated below (approximately, with overall tallying to 100%) : (a) Supply : 90-92% (b) E&C : 6-8% (c) O&M : 2-3%	Acceptable / Not acceptable	
14	Warranty / Guarantee	(a) Supply : 42 months from the date of supply or 36 months from the date of I&C whichever is earlier.	(a) Acceptable / Not acceptable	
		(b) Workmanship & I&C : 36 months from the date of commissioning.	(b) Acceptable / Not acceptable	
15	Pre Shipment Inspection	Pre Shipment Inspection will be carried out by BHEL/ Customer for which test report shall be sent one week in advance.	Acceptable / Not acceptable	
16	Penalty	Penalty of 0.5% per week at the basic price of the good for undelivered quantity of supply portion, subject to a maximum of 10%. For Supply, Pre Shipment Inspection Call Letter Date (Receipt of test report) will be treated as delivery for purpose of penalty. For other activities the activity completion date as certified by Engg. will be considered for penalty calculation.	Acceptable / Not acceptable	
		For any deviation, loading will be done as per Clause 25.B of Enquiry - General Terms & Conditions (Ref : SCPV/BOS/01-Rev 00)	Acceptable / Not acceptable	
17	Road Permit	Road permit if applicable will be given by BHEL before Dispatch of ordered Items	BHEL	
18	PBG	(a) PBG shall be furnished in the BHEL prescribed format. (b) Deviation if any Please specify	Acceptable / Not acceptable	
19	Despatch Documents	Complete set of despatch documents in 3 sets shall be forwarded to BHEL directly. Despatch documents include Commercial Invoice, Excise Invoice (if ED is applicable), Lorry receipt (L/R), Packing list, Warranty certificate, Insurance intimation letter, & Original Performance Bank Guarantee (Directly from issuing bank to BHEL). One set of Invoice, Packing list and L/R shall be faxed immediately after despatch to BHEL-EDN, Bangalore.	Acceptable / Not acceptable	
20	Reverse Auction	BHEL reserves the right to conduct Reverse auction. Procedure for the same will be informed by BHEL. Please confirm your acceptance for reverse auction.	Acceptable / Not acceptable	
21	Other terms & conditions	For any other Terms and Conditions, kindly refer to the enclosed Enquiry - General Terms & Conditions (Ref : SCPV/BOS/01-Rev 00)	Acceptable / Not acceptable	
22	Validity	(a) Quotation should remain valid for a period of 90 days from the due date	Acceptable / Not acceptable	
		(b) Deviation if any Please specify	(b)	
23	Bank Charges	(a) All Bank charges to respective accounts	Acceptable / Not acceptable	
		(b) Deviation if any Please specify	(b)	
24	Shipment	Kindly indicate the state from where the shipment will take place. This is for the purpose of assessment of Tax.	State :	

AUTHORISED SIGNATORY WITH SEAL

TECHNICAL BID ENCLOSURE FOR COMPLIANCE OF QUOTE : UNPRICED BID										
RFQ No.HBSBOS016 RFQ DATE : 17.09.2014 DUE DATE : 10.10.2014										
SI No.	Material	Short Text	Quantity	Unit	Quoted	Taxes				Remarks
						**ED %	CST %	VAT %	Service Tax %	
1	PS0679042610	Supply of 66KV switchyard bay	1	ST	YES/NO	NA			NA	Taxes Included
2	PS0679042628	E&C of 66KV switchyard bay at 10MW KPCL	1	AU	YES/NO	NA	NA	NA		Taxes Included
3	PS0679042636	O&M for 1st year of 66KV switchyard bay	1	AU	YES/NO	NA	NA	NA		Taxes Included
4	PS0679042644	O&M for 2nd year of 66KV switchyard bay	1	AU	YES/NO	NA	NA	NA		Taxes Included
5	PS0679042652	O&M for 3rd year of 66KV switchyard bay	1	AU	YES/NO	NA	NA	NA		Taxes Included
E. Freight Charges including Service Tax @ 12.36% on 25% of Freight Value : Included in Unit rate										
F. Insurance Charges : Included in Unit rate										

****ED shall not be considered as the project is under MNRE approval.Hence all inclusive rate for Supply is to be quoted without ED for Supply.**

However, the prevailing rate of ED shall be indicated in SI No.6 of Annexure B.

NOTE :

1.Your quoted prices shall be on "FOR" basis to site.

2.The quoted prices shall be inclusive of all Taxes & Duties, Packing & Forwarding charges.Freight & Insurance.

3.However, the percentage of taxes considered against each item may pls be indicated in the column for Taxes for the purpose of availing Tax Credit.

4. The above format only shall be used for compliance.No changes are acceptable.(Reproducing on your letter head is acceptable.)

Authorized Signatory with seal

PRICE BID											
RFQ No.HBSBOS016 RFQ DATE : 17.09.2014 DUE DATE : 10.10.2014											
Sl No.	Material	Short Text	Quantity	Unit	Unit Rate (Rs.)	Total Value (Rs.) (Unit Rate X Qty)	Taxes				Remarks
							**ED %	CST %	VAT %	Service Tax %	
A. SUPPLY											
1	PS0679042610	Supply of 66KV switchyard bay	1	ST			NA			NA	Taxes Included
	Unit Rate in words :										
2	PS0679042628	E&C of 66KV switchyard bay at 10MW KPCL	1	AU			NA	NA	NA		Taxes Included
	Unit Rate in words :										
3	PS0679042636	O&M for 1st year of 66KV switchyard bay	1	AU			NA	NA	NA		Taxes Included
	Unit Rate in words :										
4	PS0679042644	O&M for 2nd year of 66KV switchyard bay	1	AU			NA	NA	NA		Taxes Included
	Unit Rate in words :										
5	PS0679042652	O&M for 3rd year of 66KV switchyard bay	1	AU			NA	NA	NA		Taxes Included
	Unit Rate in words :										
D. Freight Charges including Service Tax @ 12.36% on 25% of Freight Value : Included in Unit rate											
E. Insurance Charges : Included in Unit rate											

****ED shall not be considered as the project is under MNRE approval.Hence all inclusive rate for Supply is to be quoted without ED for Supply. However, the prevailing rate of ED shall be indicated in Sl No.6 of Annexure B.**

NOTE :

1.Your quoted prices shall be on "FOR" basis to site.

2.The quoted prices shall be inclusive of all Taxes & Duties, Packing & Forwarding charges.Freight & Insurance.

3.However, the percentage of taxes considered against each item may pls be indicated in the column for Tax assessment.

4. The above format only shall be used for quoting.No changes are acceptable.(Reproducing on your letter head is acceptable.)

Authorized Signatory with seal

Bharat Heavy Electricals Ltd.,
(A Government of India undertaking)
Electronics Division
PB No.2606, Mysore Road, Bangalore-560026, India

Enquiry - General Terms & Conditions (Two part bid)

I. Enquiry / Request for Quotation (RFQ):

- (a) Any Purchase Order resulting from this enquiry shall be governed by **these general terms and conditions listed below and special terms and conditions, if any, along with this enquiry** of Bharat Heavy Electricals Limited, Electronics Division, Bangalore-560026 (**hereinafter referred to as BHEL EDN**).
- (b) Any of the terms and conditions not acceptable to vendor, shall be explicitly mentioned in the quotation. Otherwise, it will be treated as that all terms and conditions of this enquiry are acceptable.
- (c) If counter terms and conditions are offered by vendor, BHEL EDN shall not be governed by such terms and conditions, unless it is agreed and incorporated in the Purchase Order of BHEL EDN.
- (d) Any deviation to the terms and conditions not mentioned in the quotation by vendor in response to this enquiry will not be considered, if put forth subsequently or after issue of order, unless clarification is sought for by BHEL EDN and agreed upon in the Purchase Order of BHEL EDN.
- (e) BHEL EDN reserves the right to adopt Reverse Auction for the enquiry sent, at its discretion.
- (f) BHEL EDN shall be at liberty to cancel the tender at any time, before ordering, without assigning any reason.
- (g) Any specific terms and conditions to be complied will be mentioned in RFQ.**

II. General Terms and conditions:

1. TWO PART BID: Quotation shall be submitted in two part bid i.e.

(a) Techno-commercial i.e., Un-priced Bid (in one sealed envelope):

Techno-commercial bid shall be submitted with complete description of the equipment, specification compliances to the enquired specification and all the commercial terms & conditions indicated in the **COMMERCIAL TERMS (ANNEXURE -A for Foreign Purchase and ANNEXURE-B for Indigenous Purchase)**. Any other enclosure, which the vendor wishes to submit like product catalogue, technical literature etc., may also be submitted in a sealed envelope super scribed clearly as **“TECHNO-COMMERCIAL BID” with RFQ No. and DUE DATE**. An un-priced copy of price bid (without price) as per **ANNEXURE A-1 for Foreign Purchase and ANNEXURE B-1 for Indigenous Purchase** shall also be enclosed with the techno-commercial bid for evaluation of commercial terms.

The vendor shall not give the price in the technical bid.

Confirmation to BHEL specifications shall be indicated by the vendor in the respective columns provided in the purchase specification wherever applicable. Deviations to the specification / item description, if any shall be brought out clearly indicating **“DEVIATION TO BHEL SPECIFICATION”** without fail as a part of technical offer.

Compliance to Pre-qualification criteria (if applicable) shall also be enclosed with the Techno-commercial bid.

Manufacturer’s name, their trade mark and brand, part number, alternate material to the one asked in enquiry, if any, should be mentioned in quotation and illustrative leaflets giving technical particulars etc. are to be attached to facilitate consideration and technical evaluation of the quotation. BHEL EDN material code number (as in enquiry) shall be indicated for each item quoted.

(b) Price Bid (in one sealed envelope):

Price bid should contain basic unit prices, discount if any, applicable taxes & duties, packing & forwarding charges (if applicable), Freight & insurances (if applicable), FOB charge (if applicable) etc., in a sealed envelope super scribed clearly as **“PRICE BID” with RFQ No. and DUE DATE**.

It is preferred to indicate the rates in both figures and words. In such case, if there is a difference / discrepancy

Signature of tenderer / with seal

between the rates in figures and words, guidelines as per Annexure H shall be followed. **Price bid shall be quoted as per ANNEXURE A-2 for Foreign Purchase and ANNEXURE B-2 for Indigenous Purchase.**

(c) Tender Offer (above two envelopes inside another sealed envelope):

Both these sealed envelopes [(a) Techno-commercial i.e., un-priced Bid and (b) Price Bid] shall be kept in a single sealed envelope and super scribed clearly with **RFQ No. and DUE DATE.**

2. The above sealed envelope (Tender) shall reach our office on or before the due date by 13:00 hrs. Quotations are to be dropped in the tender box marked for the OPENING ON respective days i.e., **MONDAY (BOX No.4)/ WEDNESDAY (BOX No.6)/ FRIDAY (BOX No.8)** kept at BHEL-EDN's Reception area of our works with caption "**CE, SC & PV, DEFENCE**". **Quotations also can be dispatched by Couriers / Registered post / FAX / e-mail to the Purchase Executive indicated in the RFQ at the risk of vendor / bidder.**

Quotation through courier / register post / fax / email when addressed to the specific fax number and email address given in the enquiry, to be sent well in advance to enable BHEL EDN purchase personnel to drop in the tender box before the scheduled opening date and time. Vendor is fully responsible for lack of secrecy on information of such quotations. Vendor shall confirm with the concerned purchase executive after sending the offer regarding such delivery mode to ensure participation. BHEL EDN is not responsible for any delay in receipt of quotation sent by vendor through post/fax/email.

Late Tenders i.e., Tenders received after due date & time will be rejected.

3. The rate quoted shall be in units stated in the enquiry. Where quotation is in terms of unit other than that in enquiry, relationship between the two units must be furnished in the quotation.
4. As far as possible, the quotations shall be free from corrections / overwriting. Corrections / overwriting, if any should be signed by authorized person with the company seal. Any typographical errors, totaling mistakes, currency mistakes, multiplication mistakes, summary mistakes observed in your priced bids, BHEL may consider whichever is beneficial to BHEL for evaluation. Vendor shall doubly ensure that the quote is correct and complete. The corrections / overwriting if any shall be signed with the seal.
5. Quotations are to be duly signed. Unsigned bids/offers are liable for rejection.
6. Tenders will be opened at **13:30 hrs** & the venue is New Engineering Building, 2nd floor, MM conference hall, BHEL EDN, Bangalore. All the tenderers or their authorized representatives (with authorization letter from their principals) may witness opening of techno-commercial bid on the due date.
7. After evaluation of techno-commercial bids, price bids of only those which are technically & commercially accepted, will be opened on a subsequent date, which will be intimated to the concerned in advance for witnessing of price bid opening.
8. The quantity in each item to be purchased may vary from quantity enquired according to the actual requirement at the time of placing the purchase order.

9. DUN & BRADSTREET REPORT (for Foreign purchase):

In case of foreign vendors, BHEL reserves the right to verify the Dun & Bradstreet report during techno-commercial scrutiny. Please mention DUN Number in **Techno-Commercial bid.**

10. Payment of Agency Commission to Indian Agent (for Foreign purchase):

- a. BHEL shall deal directly with foreign vendors, wherever required, for procurement of goods. However, if the foreign principal desires to avail of the services of an Indian agent, then the foreign principal should ensure compliance to regulatory guidelines - which require mandatory submission of an Agency Agreement.
- b. It shall be incumbent on the Indian agent and the foreign principal to adhere to the relevant guidelines of Government of India, issued from time to time.

Signature of tenderer / with seal

- c. The Agency Agreement should specify the precise relationship between the foreign OEM / foreign principal and their Indian agent and their mutual interest in the business. All services to be rendered by agent/ associate, whether of general nature or in relation to the particular contract, must be clearly stated by the foreign supplier/ Indian agent. Any payment, which the agent or associate receives in India or abroad from the OEM, whether as commission or as a general retainer fee should be brought on record in the Agreement and be made explicit in order to ensure compliance to laws of the country.
- d. Any agency commission to be paid by BHEL to the Indian agent shall be in Indian currency only.
- e. Tax deduction at source is applicable to the agency commission paid to the Indian agent as per the prevailing rules.
- f. In the absence of any agency agreement, BHEL shall not deal with any Indian agent (authorized representatives / associate / consultant, or by whatever name called) and shall deal directly with the foreign principal only for all correspondence and business purposes.
- g. The “Guidelines for Indian Agents of Foreign Suppliers” shall apply in all such cases.
- h. The supply and execution of the Purchase Order (including indigenous supplies/ service) shall be in the scope of the OEM/ foreign principal. The OEM/ foreign principal should submit their offer inclusive of all indigenous supplies/ services and evaluation will be based on ‘total cost to BHEL’. In case OEM/ foreign principal recommends placement of order(s) towards indigenous portion of supplies/ services on Indian supplier(s)/ agent on their behalf, the credentials/ capacity/ capability of the Indian supplier(s)/ agent to make the supplies/ services shall be checked by BHEL as per the extant guidelines of Supplier Evaluation, Approval & Review Procedure (SEARP), before opening of price bids. It will be the responsibility of the OEM/ foreign principal to get acquainted with the evaluation requirements of Indian supplier/ agent as per SEARP available on www.bhel.com.

The responsibility for successful execution of the contract (including indigenous supplies/ services) lies with the OEM/ foreign principal. All bank guarantees to this effect shall be in the scope of the OEM/ foreign principal.

11. Installation & Commissioning:

- (a) Scope will be as per Purchase Specification. I&C value should be quoted separately by bidders.
- (b) Wherever, Service Tax is applicable –
- (c)
 1. The Tenderers shall furnish the Service Tax Registration Number in their offer.
 2. If the Tenderer is not having Service Tax Registration Number, he shall submit an undertaking to the effect that,
 - a. in case he is awarded the contract, he shall register with Service Tax Authorities and furnish the Registration Number before commencement of work, OR
 - b. his turnover value is below the threshold limit prescribed by the Service Tax Act and in case he is awarded the contract, whenever his turnover crosses the threshold limit at any time during the execution of the contract, he shall forthwith register with Service Tax Authorities and furnish the Registration Number to BHEL. (This sub-clause is NOT applicable where the taxable turnover of the present tender is above the prescribed threshold limit).
 3. Any offer not complying with the above clauses is liable to be rejected.
 4. The above clauses apply even where the price quoted is “inclusive of taxes”.
 5. If the Service Tax Registration Number is not furnished to BHEL before the first bill is submitted (except as provided in Clause 2(b) above), the bills will not be passed (even if the price is “inclusive of taxes”).
 6. In case of contracts involving multiple bills, every bill (commencing with the 2nd bill) shall be accompanied with a declaration that the contractor has discharged his tax liability on the earlier bill (i) by paying the money to the Government (along with Challan details) or (ii) by utilization of Input Service Tax Credit available with him or (iii) being exempt as his turnover continues to be below the threshold limit. In the absence of such a declaration, the bill shall not be passed.
 7. In case of contracts involving a single bill, the bill shall be accompanied with an undertaking that the contractor shall discharge his tax liability on that bill as per law.

- 12. **TOTAL COST TO BHEL:** Purchase order will be placed on the lowest quotation (L1) only among the technically & commercially accepted quotations. Lowest quotation (L1) is determined on the basis of the total cost to BHEL. Loading Factors for deviation to BHEL Commercial terms and conditions will be considered.

Signature of tenderer / with seal

For Foreign offers, the Exchange rate (TT selling rate of SBI) shall be taken as under.

Single part bids	Date of Tender opening
Two/Three part bid	Date of Part-1 bid opening
Reverse Auction	Date of Part-1 bid opening

If the relevant day happens to be a bank holiday, then the forex rate as on the previous bank (SBI) working day shall be taken.

- (1) If Freight is quoted extra, original money receipt from Transporter shall be submitted for payment of Freight charges.
- (2) C-form : For issue of form "C", vendor has to furnish "E1/E2" form.

12. FIRM PRICE:

Rates quoted should be firm from the date of offer, till completion of supply. No enhancement in the rates and changes in the techno-commercial terms will be allowed once the quotation is accepted and order is placed.

If Installation & Commissioning is in vendor's scope, then the price shall remain FIRM till commissioning & handing over of the complete system.

13. TERMS OF PAYMENT:

1.SUPPLY FOR FOREIGN PURCHASE : Payment will be made against "SIGHT DRAFT" on presentation of documents to our bankers . Payment through LC is also made subject to loading factors as per Clause 25 (A). For LC payment bank charges within India will be borne by BHEL and outside India will be to vendor's account.

The payment terms are as follows:

SIGHT DRAFT PAYMENT (direct payment):

SUPPLY :

(a) **I&C not included in vendor's scope :** 90% payment of Supply value + 100% Taxes shall be made with 45 days credit from the date of receipt of material at site. Balance 10% on execution of PBG valid for warranty period + 6 months claim period from any of the BHEL Consortium banks.

(b) **Supply & I&C in vendor's scope :** 80% payment of Supply value + 100% Taxes shall be made with 45 days credit from the date of receipt of material at site. 10% on completion of I&C and certification line item wise on pro-rata basis. Balance 10% on execution of PBG valid for warranty period + 6 months claim period from any of the BHEL Consortium banks..

(B) FOR INDIGENOUS PURCHASE (DIRECT PAYMENT):

1. For Supply :

(a) **I&C not included in vendor's scope :** 90% payment of basic Supply value + 100% Taxes and duties shall be made with 45 days credit from the date of receipt of material at site. Balance 10% on execution of PBG valid for warranty period + 6 months claim period from any of the BHEL Consortium banks. PBG value shall be 10% of basic supply PO value.

(b) **Supply and I&C in vendor' scope :** 80% payment of basic Supply value + 100% Taxes and duties shall be made with 45 days credit from the date of receipt of material at site. 10% on completion of I&C and certification line item wise on pro-rata basis. Balance 10% on execution of PBG valid for warranty period + 6 months claim period from any of the BHEL Consortium banks. PBG value shall be 10% of basic supply PO value.

2. For I&C: 100% on completion of I&C and certification line item wise on pro-rata basis.

3.Civil Works : 90% on completion of activity milestone and certification line item wise from site-in charge. Balance 10% against PBG for 10% of basic Civil value valid warranty period + 6 months claim period from any of the BHEL Consortium banks. PBG value shall be 10% of basic civil PO value.

4. O&M : 100% O&M charges are payable as per RFQ terms against report certified by BHEL.

If PBG cannot not be submitted, vendors can also accept for the final 10% payment, payable after the warranty period + 6 months of claim period against supplementary invoice subject to the completion of commissioning (if applicable) as PBG is linked to

Signature of tenderer / with seal

Warranty period.

For any deviation in payment term, the offer will be loaded as per Clause 25.00.

5. ADVANCE PAYMENT: Quotations with “Advance payment/Inland LC” shall be rejected.

14. PENALTY:

Failure to supply within the delivery time as per purchase order will make the vendor liable to an unconditional penalty of 0.5 % (half percent) per week at the basic price of the goods for the undelivered quantity, subject to a maximum of 10%.

Supply : Date of issue of pre -shipment inspection/ call letter with supporting documents like test reports/conformance to test carried by the vendor will be treated as date of dispatch for the purpose of penalty calculation wherever Pre-Inspection is carried out.

For all other activities, the actual date of completion of activity as certified by concerned site-incharge will be considered for the purpose of penalty calculation.

15. PBG:

Performance Bank Guarantee (PBG) to be submitted on non-judicial stamp paper as per the BHEL prescribed format given in **ANNEXURE-E for Foreign Purchase and Annexure-F for Indigenous Purchase** for 10% of the total supply value obtained from any BHEL member (consortium) banks indicated in **ANNEXURE-G**.

The Bank Guarantee shall be submitted directly to the concerned Purchase Executive by the issuing Bank with their forwarding letter. BHEL will verify independently with the bank to establish the authenticity. Alternately, standby LC issued from approved banker can also be considered.

16. TERMS OF DELIVERY:

(a)FOR IMPORTED PURCHASE:

Price offered shall be for goods packed and delivered **FOB** Seaport,/FCA International Airport including packing, forwarding, Handling, Ancillary charges like processing of Sight Draft, negotiation charges of bank, Export declaration, Certificate of origin etc.

Packing shall be Air/Sea worthy, best suitable for trans-shipment and to take care of transit damages. If containerized, no. of containers & size of container shall be mentioned. Packing weight (gross & net) Packing dimensions shall be given prior to shipment to ascertain whether the consignment can be carried on standard cargo in contract or as ODC.

Wooden packing material for all the foreign consignments should be treated as per ISPM-15 & **Fumigation / Phytosanitary certificate** to be submitted to the freight forwarders/ BHEL along with the invoice, B/L, packing list etc.

Vendors shall indicate the name of International Airport/Seaport. Approved Airports are as per **Annexure-C**. The consignment shall be handed over to BHEL approved freight forwarder as mentioned in PO.

(b) FOR INDIGENOUS PURCHASE:

Equipment shall be delivered on “FOR SITE” basis, inclusive of freight, packing, insurance & forwarding charges.

Packing shall be Road / Rail / Air / Sea worthy, best suitable for transshipment and to take care of transit damages.

Smaller consignments can be dispatched through Courier services/ RPP with the prior approval of the purchasing Executive.

17. DELIVERY REQUIREMENT:

Delivery date mentioned in RFQ is tentative. Actual requirement is as per RFQ terms & conditions.

18. VALIDITY:

Quotation should remain valid for a period of **90 days** from the date of technical bid opening.

19. POST-ORDER REQUISITES:

- a. Vendor shall give an Order Acknowledgement indicating the delivery date within one week of receipt of PO.
- b. Pre-shipment inspection at vendor’s works, if required, will be carried out by BHEL/Customer. Required assistance will have to be provided by the vendor at the time of pre-shipment inspection.
- c. Test certificates, Calibration certificates and warranty certificates as stipulated at the time of ordering shall be furnished.

Signature of tenderer / with seal

- d. Items shall be dispatched by Air worthy /Sea worthy/ Road worthy packing. Any damage and later rejection, due to poor / improper packing shall be to vendor's account.
- e. Any damage/rejection should be made good or replaced immediately without any extra cost to BHEL such as freight, duties, taxes etc. The liability is restricted to the value of the order.
- f. Wherever commissioning is involved, it shall be carried out by the vendor's qualified engineers. Scope of work includes installation, commissioning and start-up trials till satisfactory performance level is reached as certified by BHEL.
- g. BHEL will not be responsible for any loss, damage or injuries to vendor's personnel sustained during installation / commissioning / start-up trials. Vendor shall ensure compliance with all statutory requisites as laid down by local bodies, state & Central Government. Vendor shall indemnify BHEL for all damages/ losses to various personnel during their presence in BHEL's premises for whatever purpose.
- h. Suitable markings & damage control indicating devices shall be provided where applicable.
- i. Equipment shall comply with the standard requirements of ISO 14001 & OHSAS 18001.

20. RISK PURCHASE:

The purchaser at his discretion may also make purchase of the materials NOT supplied in time at the RISK & COST of the supplier. In this event, it will be obligatory on the part of the supplier who fails to supply the goods in time to make good to BHEL any loss due to such risk purchase.

21. GENERAL TERMS AND CONDITIONS GOVERNING REVERSE AUCTION (RA):

- (a) BHEL reserves the right to go for Reverse Auction (RA) instead of opening the sealed envelope price bid, submitted by the bidder. This will be decided after techno-commercial evaluation. All bidders to give their acceptance for participation in RA.
Non-acceptance to participate in RA may result in non-consideration of their bids, in case BHEL decides to go for RA.
- (b) In case BHEL decides to go for Reverse Auction, only those bidders who have given their acceptance to participate in RA will be allowed to participate in the Reverse Auction. Those bidders who have given their acceptance to participate in Reverse Auction will have to necessarily submit "online sealed bid" in the Reverse Auction. Non-submission of "online sealed bid" by the bidder will be considered as tampering of the tender process and will invite action by BHEL as per extant guidelines in vogue."
- (c) **Kindly refer to Annexure D for Terms & Conditions of Reverse Auction.**
- (d) Vendor shall confirm acceptance for RA in **ANNEXURE A/B.**

22. REGRET LETTER: In case any vendor is unable to quote, vendor shall send a regret letter.

23. Any dispute arising out of this, shall be referred to the sole arbitration of Head of Dept. Materials Management of group concerned, BHEL EDN or any other officer nominated by him and his award shall be final and binding on the parties. The venue of the arbitration in all cases shall be Bangalore, India.

24. Any legal suit in respect of this enquiry lies in the court of Jurisdiction of Bangalore (India) only.

25. LOADING FACTORS:

Loading factors as detailed below will be added to the quoted price (basic) to evaluate the lowest quote for non compliance of BHEL standard commercial term.

A (i). For non compliance of standard Terms of payment (For Foreign Purchase Orders)

Sl. No.	BHEL standard term	If you quote	Loading factor in % for non-compliance
1	80% against "SIGHT DRAFT" + 20% after commissioning and against PBG(where both commissioning & PBG are applicable)	Payment through Letter of Credit (LC)	10%

In general, if the quote is through L/C, it shall be opened 30 days prior to dispatch and valid for 3 months.

Signature of tenderer / with seal

A(ii).For non compliance of standard Terms of payment (For Indigenous Purchase Orders)

Sl. No.	BHEL standard term	If you quote	Loading factor in % for non-compliance
1	As per RFQ Terms	Any other Payment term	10%

B.For non compliance of standard Terms of Penalty

Sl. No.	BHEL standard term	If you quote	Loading factor for non-compliance
1	Penalty of 0.5% per week subject to max. of 10% on the basic value of the items not supplied /delayed	Other than the above.	Loading Factor 10%-Quoted Max %

26. Non Compliance of Warranty terms : Offers not complying with Warranty terms as per RFQ Terms is liable for rejection.

ANNEXURE- C***LIST OF INTERNATIONAL AIRPORTS***

Sl. No	Country	Air Ports
1	Austria	Vienna, Linz, Graz
2	Australia	Sydney, Melbourne, Perth
3	Belgium	Antwerp, Brussels
4	Canada	Toronto, Montreal
5	China	Shanghai
6	Cyprus	Lamaca
7	Czech Republic	Prague (Via Frankfurt)
8	Denmark	Copenhagen
9	Egypt	Cairo
10	Finland	Helsinki
11	France	Paris (Rossy), Lyon
12	Germany	Darmstadt, Manheim, Nurnberg, Hamburg, Stuttgart, Munich, Koln, Dusseldorf & Hannover, Frankfurt, Berlin
13	Hong Kong	Hong Kong
14	Italy	Rome, Milan, Turin, Bologna, Florence
15	Ireland	Dublin
16	Israel	Telaviv
17	Japan	Tokyo, Osaka
18	Malaysia	Kuala lumpur, Penang
19	Netherlands	Amsterdam, Rotterdam
20	New Zealand	Auckland
21	Norway	Oslo
22	Oman	Muscat
23	Philippines	Manila
24	Romania	Bucharest
25	Russia	Moscow
26	Saudi Arabia	Riyad
27	Singapore	Singapore
28	Slovakia	Bartislowa
29	South Africa	Johannesburg, Durban
30	South Korea	Kimpo
31	Spain	Barcelona
32	Sweden	Stockholm, Gothenburg, Milano
33	Switzerland	Basle, Zurich, Geneva
34	Taiwan	Taipei
35	U.A.E.	Dubai
36	U.K.	Landon (Heathrow), Newcastle, Oxford, Cheltham, Bristol, Welling borough, Birmingham, East Midland, Manchester, Leeds, Glasgow.
37	U.S.A.	New York, Chicago, San Francisco, Los Angeles, Atlanta
38	Ukraine	Kiev

Annexure - D**Terms & Conditions of Reverse Auction**

Against this enquiry for the subject item/ system with detailed scope of supply as per enquiry specifications, BHEL may resort to "REVERSE AUCTION PROCEDURE" i.e., ON LINE BIDDING (THROUGH A SERVICE PROVIDER). The philosophy followed for reverse auction shall be English Reverse (No ties).

- (1) For the proposed reverse auction, technically and commercially acceptable bidders only shall be eligible to participate.
- (2) Those bidders who have given their acceptance for Reverse Auction (quoted against this tender enquiry) will have to necessarily submit 'online sealed bid' in the Reverse Auction. Non-submission of 'online sealed bid' by the bidder for any of the eligible items for which techno-commercially qualified, will be considered as tampering of the tender process and will invite action by BHEL as per extant guidelines in vogue.
- (3) BHEL will engage the services of a service provider who will provide all necessary training and assistance before commencement of on line bidding on internet.
- (4) In case of reverse auction, BHEL will inform the bidders the details of Service Provider to enable them to contact & get trained.
- (5) Business rules like event date, time, bid decrement, extension etc. also will be communicated through service provider for compliance.
- (6) Bidders have to fax the Compliance form (annexure IV) before start of Reverse auction. Without this, the bidder will not be eligible to participate in the event.
- (7) In line with the NIT terms, BHEL will provide the calculation sheet (e.g., EXCEL sheet) which will help to arrive at "Total Cost to BHEL" like Packing & forwarding charges, Taxes and Duties, Freight charges, Insurance, Service Tax for Services and loading factors (for non-compliance to BHEL standard Commercial terms & conditions) for each of the bidder to enable them to fill-in the price and keep it ready for keying in during the Auction.
- (8) Reverse auction will be conducted on scheduled date & time.
- (9) At the end of Reverse Auction event, the lowest bidder value will be known on auction portal.
- (10) The lowest bidder has to fax/e-mail the duly signed and filled-in prescribed format for price breakup including that of line items, if required, (Annexure VII) as provided on case-to-case basis to Service provider within two working days of Auction without fail.
- (11) In case BHEL decides not to go for Reverse Auction procedure for this tender enquiry, the Price bids and price impacts, if any, already submitted and available with BHEL shall be opened as per BHEL"s standard practice.
- (12) Bidders shall be required to read the "Terms and Conditions" section of the auctions site of Service provider, using the Login IDs and passwords given to them by the service provider before reverse auction event. Bidders should acquaint themselves of the „Business Rules of Reverse Auction", which will be communicated before the Reverse Auction.
- (13) If the Bidder or any of his representatives are found to be involved in Price manipulation/ cartel formation of any kind, directly or indirectly by communicating with other bidders, action *as per extant BHEL guidelines*, shall be initiated by BHEL and the results of the RA scrapped/ aborted.
- (14) The Bidder shall not divulge either his Bids or any other exclusive details of BHEL to any other party.
- (15) In case BHEL decides to go for reverse auction, the H1 bidder(s) (whose quote is highest in online sealed bid) may not be allowed to participate in further RA process.

Signature of tenderer / with seal

ANNEXURE-E**PERFORMANCE BANK GUARANTEE
(FOR FOREIGN PURCHASE ORDERS)
BANK NAME AND ADDRESS**

Bharat Heavy Electricals Limited (BHEL),
Electronics Division,
PB No. 2606,
Mysore Road,
BANGALORE- 560 026
INDIA
Dear Sirs,

Ref: CONTRACT PERFORMANCE GUARANTEE.

WHEREAS you have entered into a contract reference No PO NO. _____ with M/s _____ having its registered office at _____ for the supply of _____ as detailed in your purchase order No. _____ which is hereinafter referred to as "the said contract" and WHEREAS M/s _____ has undertaken to produce a Bank Guarantee for 10% (Ten Percent) of _____ the contract price amounting to _____ (_____) to secure its obligations to Electronics Division, BHEL having its registered office at New Delhi for the performance of the contract including the warranty of the equipment supplied, We _____ Bank _____ hereby expressly, irrevocably and unreservedly undertake and guarantee as principal obligors on behalf of M/s _____ that in the event Bharat Heavy Electricals Ltd. (B.H.E.L.) declares to us in writing that M/s _____ has not fulfilled any obligation according to the contractual obligation of the said contract, to pay you on demand and without demur to Bharat Heavy Electricals Ltd., Electronics Division , Mysore Road, P.B.No. 2606, Bangalore-560 026, India an amount of _____ (in words _____) subject to as may be determined below:

- 1) Notwithstanding any right M/s. _____ may have directly against you or any disputes raised by M/s _____, Your written demand shall be conclusive evidence to us that repayment is due under the terms of the said contract and shall be binding on us.
- 2) We shall not be discharged or released from this undertaking and Guarantee by any arrangements, variations made between you and M/s. _____ with or without our consent and Knowledge or by any alterations in the obligations of M/s. _____ by any forbearance whether as to payment, time, performance or otherwise.
- 3) This guarantee shall remain valid until the end of twenty-four weeks after the close of the warranty period or until the same is reported by BHEL to us whichever is earlier.
- 4) We agree and undertake not to revoke this guarantee during its validity unless discharged in writing by you subject to the provision of clause (7) below.
- 5) This guarantee shall be a continuing guarantee subject to the foregoing and shall not be discharged by any change in the constitution of the Bank or M/s. _____.
- 6) This guarantee shall be governed by and constructed in accordance with the Laws of India.
- 7) At any time _____ Bank may render this guarantee null and void by paying to Bharat Heavy Electricals Ltd. the full amount being _____ (in words _____)

Note:

- (1) To be executed in Non-Judicial stamp paper by any authorized Indian Bank.
- (2) To be submitted directly by banker to concerned executive in purchase dept., Please give BHEL address to banker.
- (3) Do not enclose with Bank document.
- (4) Any Modification & omissions to this are not permitted

Signature of tenderer / with seal

ANNEXURE - F**PERFORMANCE BANK GUARANTEE
(FOR INDIGENOUS PURCHASE ORDERS)**

THIS DEED OF GUARANTEE made and executed on the _____ day of _____ (year), by the _____ (Bank), registered under the Companies Act 1956/Nationalized Bank constituted under the Banking Companies (acquisition and transfer of undertakings) Act constituted under the State Bank of India Act / Subsidiary Banks Act, having its registered / head office at _____ represented herein by its Branch Manager / authorized representative Sri. _____ & Sri. _____ (Hereinafter called 'guarantor' which term shall mean and include its successors and assigns)

IN FAVOUR OF BHARAT HEAVY ELECTRICALS LIMITED

_____ (Buyer's Name), a company registered under the companies Act, 1956 having its registered office at BHEL House at Siri Fort , New Delhi -100 049 and its Electronics Division at Mysore road, Bangalore-26 (hereinafter referred to as the 'Company' Which term shall include its successors and assigns):

Whereas the company has placed an order on _____ (State the name of the company / firm and its address) (hereinafter referred to as the 'Supplier' which term shall mean and include its liquidators, successors and assign) for the supply of system under order / Contract No. Dt. _____

AND WHEREAS the supplier has agreed to supply the materials and carryout the works as detailed and in accordance with the terms set out in the said order/contract.

AND WHEREAS the company is not required to pay to the supplier a sum of Rupees _____ being the 10% of the value of the goods supplied / Works performed / Services rendered under the said order / contract between the supplier and the company, till the company is satisfied with the mechanical Warranties and the performance standards stipulated in the said order / contract between the company and the supplier has been duly fulfilled, except against a Bank Guarantee for the said sum of Rs _____ in favour of the company by reputed Bank, in which case the company has agreed to make payment to the supplier of the said sum of Rupees _____ being (..%) of the value of the goods supplied / Works performed / Services rendered under the agreement between the supplier and the company and the Guarantor has at the request of the supplier, agreed to furnish this Guarantee subject to the terms and conditions stated below:

NOW THIS DEED WITNESSES THAT IN pursuance of the above said agreement, the guarantor hereby agrees and covenants With company is as follows :-

- 1) That during the period this contract of Guarantee remains effectual, the guarantor shall be liable in respect of the amount due and owing to the company in respect of the payments to the extent of Rs _____ (in words) _____ against any loss or damage caused to or suffered by the company by reasons of any breach of the terms of the said order / contract / Agreement by the supplier.
- 2) The Guarantor hereby undertakes to pay the amounts due and payable under this guarantee without any demur, merely on demand from the company intimating that the amount claimed is due by way of loss or damage caused to or suffered or would be caused or suffered by the supplier of any terms contained in the said order / contract. Any such demand made on the guarantor shall be conclusive as regards the amount due and payable by the Guarantor irrespective of the fact whether the Contractor / supplier admits or denies.
- 3) The Guarantor further agrees that the agreement herein contained shall remain in force and effect till all the supplies to be made / Works to be performed / Services to be rendered under the said order / contract / agreement are completed to the entire satisfaction of the company or till company certifies that the terms and conditions of the said order / contract / agreement have been fully and properly carried out by the said supplier and accordingly discharges the Guarantee. Unless a demand or claim under this guarantee is made on the guarantor in writing on or before the expiry of claim period indicated in clause 6 below, the guarantor shall be discharged from all the liability under this guarantee thereafter.
- 4) The guarantor further agrees with the company that the company shall have the fullest liberty without the consent of the guarantor and without effecting in any manner the obligations of the guarantor hereunder to vary any of the terms of the said order / contract / agreement or extend the time of performance by the said supplier from time to time or refrain from exercising the power exercisable by the company against the said supplier or to forebear or omit to enforce any of the terms and conditions relating to the said order / contract / agreement, and the guarantor shall not be relieved of its liability in whole or in part , by reason of any act, commission or forbearance on the part of the company or by reason of any such variation, or extension being granted to the said

Signature of tenderer / with seal

supplier or by reason of any such matter or thing whatsoever which under the law relating to sureties would but for this provision have effect of so relieving the guarantor.

- 5) The guarantor undertakes not to revoke this guarantee during its currency except with the previous consent of the company in writing.
- 6) Notwithstanding anything herein above contained, the liability of the guarantor under these presents is restricted to Rs _____. The guarantee shall be in force till its expiry on _____ unless a demand is made on the guarantor within SIX months from the date of expiry, all the liability of the guarantor under this guarantee shall stand fully discharged. The decision of the claimant in regard to breach of contract is final and binding on the Bank.

IN WITNESS whereof, the guarantor, acting through it authorized representative has executed this deed of Guarantee on the day, month and year first above written.

(Seal of the Bank to be affixed)

WITNESS

- 1.
- 2.

Note:

- (1) To be executed in INR 100 Non-Judicial stamp paper by any authorized Indian Bank.
- (2) To be submitted directly by banker to concerned executive in purchase dept., Please give BHEL address to banker.
- (3) Do not enclose with Bank document.
- (4) Any Modification & omissions to this are not permitted.

BHEL MEMBER BANKS (CONSORTIUM BANKS)**PBG SHALL BE ISSUED FROM THE FOLLOWING BANKS OR THEIR BRANCH OFFICES ONLY**

1	STATE BANK OF INDIA
2	PUNJAB NATIONAL BANK
3	HDFC BANK
4	SYNDICATE BANK
5	CANARA BANK
6	INDIAN BANK
7	ST. BANK OF HYDERABAD
8	ICICI BANK
9	STANDARD CHARTEREDBANK
10	UCO BANK
11	KOTAK MAHINDRA
12	ORIENTAL BANK OF COMMERCE
13	STATE BANK OF TRAVANCORE
14	CENTRAL BANK
15	IDBI BANK
16	FEDERAL BANK
17	HSBC LTD
18	DEUTSCHE BANK
19	CORPORATION BANK
20	CITI BANK
21	BANK OF BARODA
22	ABN AMRO BANK
23	UNITED BANK OF INDIA
24	VIJAYA BANK
25	UNION BANK OF INDIA
26	PUNJAB & SIND BANK
27	ANDHRA BANK
28	BANK OF INDIA
29	AXIS BANK

The above list is tentative and is subject to change from time to time.
The Purchase Executive shall be contacted for confirmation of the same.

DISCREPANCY IN WORDS & FIGURES – QUOTED IN PRICE BID

Following guidelines will be followed in case of discrepancy in words & figures-quoted in price bid:

- (a) If, in the price structure quoted for the required goods/services/works, there is discrepancy between the unit price and the total price (which is obtained by multiplying the unit price by the quantity), the unit price shall prevail and the total price corrected accordingly, unless in the opinion of the purchaser there is an obvious misplacement of the decimal point in the unit price, in which case the total price as quoted shall govern and the unit price corrected accordingly.
- (b) If there is an error in a total corresponding to the addition or subtraction of subtotals, the subtotals shall prevail and the total shall be corrected; and
- (c) If there is a discrepancy between words and figures, the amount in words shall prevail, unless the amount expressed in words is related to an arithmetic error, in which case the amount in figures shall prevail subject to (a) and (b) above.
- (d) If there is such discrepancy in an offer, the same shall be conveyed to the bidder with target date upto which the bidder has to send his acceptance on the above lines and if the bidder does not agree to the decision of the purchaser, the bid is liable to be ignored.

Signature of tenderer / with seal