



# भारत हेवी इलेक्ट्रिकल्स लिमिटेड

(भारत सरकार का उपक्रम)

## BHARAT HEAVY ELECTRICALS LIMITED

(A Govt. of India Undertaking)

TCN - 07

Ref: PSER:SCT:LPT-A1114:TCN-07

Date: 24-09-2010

Sub	Tender change notice (TCN) 07.	
Job	Civil, structural, architectural work including piling work of main plant, BOP, enabling work etc; supply, installation, maintenance of construction power and erection, testing, commissioning etc of 2x80 TPH utility boiler & aux, 2x80 TPH HRSG & aux, 2xFr5 GTG & aux, 1x13.5 MW STG & aux, 2 nos steel chimney for utility boiler, 2 nos steel chimney for HRSG, associated piping, associated electrical, associated C&I, supply & execution of BOP etc for 53 MW Combined Cycle Power Plant at BCPL, Lepetkata, Assam.	
Ref	1.0	Tender no PSER:SCT:LPT-A1114:10.
	2.0	BHEL's NIT, vide reference no PSER:SCT:LPT-A1114:2310, dated 23-07-10.
	3.0	BHEL's TCN-01, vide reference no PSER:SCT:LPT-A1114:TCN-01, dated 16-08-10.
	4.0	BHEL's TCN-02, vide reference no PSER:SCT:LPT-A1114:TCN-02, dated 30-08-10.
	5.0	BHEL's TCN-03, vide reference no PSER:SCT:LPT-A1114:TCN-03, dated 08-09-10.
	6.0	BHEL's TCN-04, vide reference no PSER:SCT:LPT-A1114:TCN-04, dated 20-09-10.
	7.0	BHEL's TCN-05, vide reference no PSER:SCT:LPT-A1114:TCN-05, dated 22-09-10.
	8.0	BHEL's TCN-06, vide reference no PSER:SCT:LPT-A1114:TCN-06, dated 24-09-10.
	9.0	All other pertinent issues till date.

With reference to above, following points/ documents, relevant to tender, may please be noted and complied with while submitting offer.

- 1.0 Amendments/ modifications/ clarifications to tender as per enclosed Annexure-A.
- 2.0 Inclusion of civil specification as per enclosed Volume-ID&II-P-7-CIVIL SPECIFICATION-R-0.
- 3.0 Revised 'No deviation certificate' as per enclosed Annexure-2. Bidder shall submit no deviation certificate as per enclosed format only.
- 4.0 All other terms & conditions shall remain unchanged.

In case offer has been already sent, bidders may submit supplementary offer in view of subsequent TCNs, if applicable.

Thanking you,

Yours faithfully,  
for BHARAT HEAVY ELECTRICALS LTD

SDGM (SCT)

Encl

- 1.0 As above.

पावर सेक्टर पूर्वी क्षेत्र (मुख्यालय)

POWER SECTOR EASTERN REGION, DJ-9/1, SECTOR-II, SALT LAKE CITY, KOLKATA - 700 091

फैक्स/Fax : (033) 23211960 फोन/Phone : बोर्ड/EPABX : 23211691, 23211798, 23211796

<b>JOB</b>	Civil, structural, architectural work including piling work of main plant, BOP, enabling work etc; supply, installation, maintenance of construction power and erection, testing, commissioning etc of 2x80 TPH utility boiler & aux, 2x80 TPH HRSG & aux, 2xFr5 GTG & aux, 1x13.5 MW STG & aux, 2 nos steel chimney for utility boiler, 2 nos steel chimney for HRSG, associated piping, associated electrical, associated C&I, supply & execution of BOP etc for 53 MW Combined Cycle Power Plant at BCPL, Lepetkata, Assam
	TENDER NO - PSER:SCT:LPT-A1114:10.

<b>SL NO</b>	<b>AMENDMENT/ MODIFICATION/ CLARIFICATION</b>
1.1	Notwithstanding anything stated in any volume of tender, it is clarified that electricity shall be provided by BHEL free of charge at 415 V at a single point within the project premises to the successful bidder for the entire scope under this tender. Successful bidder shall make their own arrangement for further distribution of electricity at different points/ locations at their own cost. Other provisions shall be as per following.
1.1.1	The bidder to arrange DG back-up for initial period of three to four months at their own cost.
1.1.2	If any other voltage level (other than normally available) is required, the same shall be arranged by contractor from power supply as above. Contractor will have to provide at his own cost necessary calibrated energy meters (tamper proof, suitably housed in a weather proof box with lock & key arrangement) at point of power supply along with calibration certificate from authorized/ accredited agency for working out the power consumption. In case of recalibration required for any reason, necessary charges including replacement by calibrated meters is to be borne by the contractor. Supply of electricity shall be governed by Indian Electricity Act and Installation Rules and other Rules and Regulation as applicable. The contractor shall ensure usage of electricity in an efficient manner and the same may be audited by BHEL time to time. In case of any major deviation from normally accepted norms is observed, BHEL will reserve the right to impose penalty as deemed fit for such cases.
1.1.3	The bidder shall have to provide earth leakage circuit breaker at each point wherever human operated electrical drives/ T&Ps are deployed.
1.1.4	The power supply will be from the available grid. BHEL shall not be responsible for any inconvenience or delay caused due to any interruption of power supply/ variation in voltage level and no compensation for delay in work can be claimed by the contractor due to such non-supply on the grounds of idle labour, machinery or any other grounds.
1.1.5	Bidder shall arrange sufficient illumination at their own cost in the working areas.
1.1.6	The contractor should ensure that the work in critical areas is not held up in the event of power breakdown. In the event of breakdown in the electric supply, if the progress of work is hampered, it will be the responsibility of the contractor to step up the progress of work after restoration of electric supply so that overall progress of work is not affected.
1.1.7	Contractor will arrange power including area illumination inside labour colony at their own cost.
1.2	It is clarified that though the scope of deployment of hydra crane by successful bidder has been specified in Volume-ID&II-P-3-R-1 under Annexure-II, the same shall also be utilized for entire scope in other areas under this tender. Bidder's quoted rates/ prices shall be in consideration to this.
1.3	Notwithstanding anything specified anywhere in any volume of the tender, it is clarified that scope of deployment of 1 no 75 T & 1 no 150 T crawler crane is excluded from the scope of successful bidder. Bidder's quoted price shall be in consideration to this.
1.4	Notwithstanding anything specified anywhere in any volume of the tender, provision of

	insurance shall stand revised as under. This will be applicable for entire scope under this tender.
1.4.1	Customer/ EIL shall arrange comprehensive MCE (marine cum erection) Insurance Policy for total project supply & services including balance of plant package covering transit risks & loss, destruction or damage during handling at site, storage, civil works, erection, testing and commissioning up to trial operation completion of each unit including theft, sabotage, fire, lightning and other natural calamities.
1.4.2	Details of insurance National Insurance Co, Dibrugarh Divisional Office, RKB Path, Dibrugarh – 786 001 Assam WAN no 200300-001 Policy no: 200300/44/09/5050000001.
1.4.3	All other terms & conditions of insurance shall be governed by provision of the above poicy.
1.5	Bidder shall note that around 1500 MT steel has been/ is being unloaded by BHEL. In view of this, bidder's scope of handling of steel under the scope of this tender is reduced by around 1500 MT. In view of this, bidder's scope of handling of steel materials would be around 1600 MT. Bidder's quoted rates/ price for civil + structural + enabling part (Part-1)(SCH-2 of Volume-IIIA) of the tender shall be in consideration to this.
1.6	Bidder's scope of handling of steel under the scope of this tender includes stacking/ storing of materials over concrete sleepers. Bidder scope shall include provision of concrete sleepers for this purpose and payment against the same will be made by BHEL as per relevant item of price schedule (sl no 24.6 of SCH-2, Volume-IIIA). After completion of the job bidder shall take back the sleepers. Bidder's quoted rate/ price shall be in consideration to this.
1.7	The description of item under sl no 22.1 of SCH-2 shall be read as under. Mobilization of minimum number of rigs with ancillaries & all equipments, complete to site for instillation of 18-20 nos 450 mm diameter driven cast-in-situ RCC piles per day and demobilization from site after completion of work as per specifications.
1.8	Follwoing items under Volume-ID&II-P-1-R-1 are excluded from the scope of this tender. 3.3.1.7, 3.3.2.3.1, 3.3.2.3.2, 3.3.2.3.5, 3.3.2.5.3, 3.3.2.5.4, 3.3.2.5.5, 3.3.2.5.6, 3.3.2.6.3, 3.3.3.2, 3.3.6, 3.3.7.
1.9	Foundation of following are included under Volume-ID&II-P-1-R-1.
1.9.1	Condensate storage tank.
1.9.2	Gas drain tank.
1.9.3	HSD oil tank for DG,
1.9.4	Gas conditioning skids.
1.9.5	FRP cooling tower.
1.9.6	Ventilation room.
1.9.7	Cleaning agent room.
1.10	Clause no 7.2.1 stands deleted.
1.11	Clasue no 7.2 shall stand revised as under. Land (around 15000 sqm) for labour colony will be provided inside project boundary wall (in the 'Spare area'), free of cost, depending on availability. The contractor to construct labour colony/ hutment as per EIII/ customer's design at their own cost. The contractor is to fulfill norms of cleanliness, sanitation, sewerage etc for labour colony, as per site requirement. However, bidder shall also note the following.
1.12	Following construction schedule is added to clause no 13.0 of Volume-ID&II-P-4-R-0. 1 <sup>st</sup> borewell shall be completed within 1 month from start of work and subsequent borewells after 1 month each thereafter.

1.13	Notwithstanding anything specified anywhere in any volume of the tender, the completion period shall be reckoned as the specified month/ period from the date of start of work, as to be certified by Construction Manager, BHEL instead of date of LOI.
1.14	Notwithstanding anything specified anywhere in any volume of the tender, the mobilization time shall be the specified time from the date of intimation of BHEL in writing to start the job instead of date of LOI.
1.15	Notwithstanding anything specified anywhere in any volume of the tender, unless specified otherwise & except for lump sum packages, the quantities of the various items mentioned in this schedule of items are approximate, based on very preliminary information and may vary to any extent or be deleted altogether. The quoted rates of each item will remain firm throughout the period of execution including extension, for reasons whatsoever, as long as variation in the total value of work executed under any part of this contract including extra items, if any but excluding any price variation remains within thirty percent ( $\pm 30\%$ ) of the contract price.
1.16	Around 10 MT of underground CW piping is included in the scope of this tender and is included in sl no 2.0 of SCH-2, Volume-III A, R-2. The scope also includes wrapping and coating with holiday testing.
1.17	Some documents containing technical specification of civil, structural etc work are attached along with this TCN. Bidder shall quote their rates/ prices taking into consideration of these documents.
1.18	Bidder shall submit offer strictly in compliance with technical specification and tender terms along with amendment/ clarifications issued till date within the due date.
1.18	All other terms & conditions shall remain unchanged.

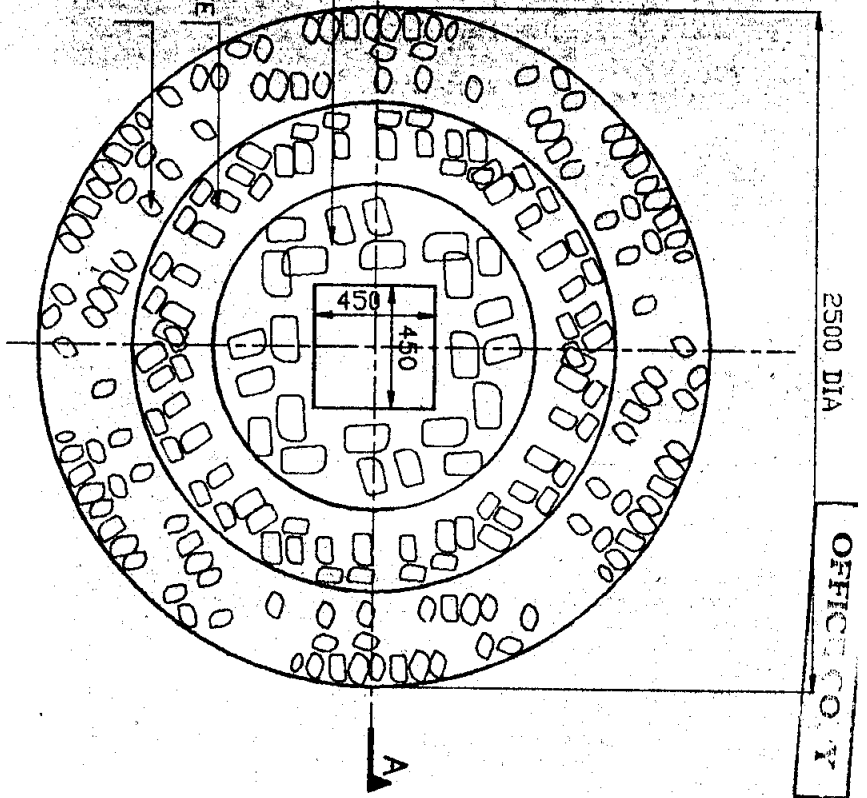
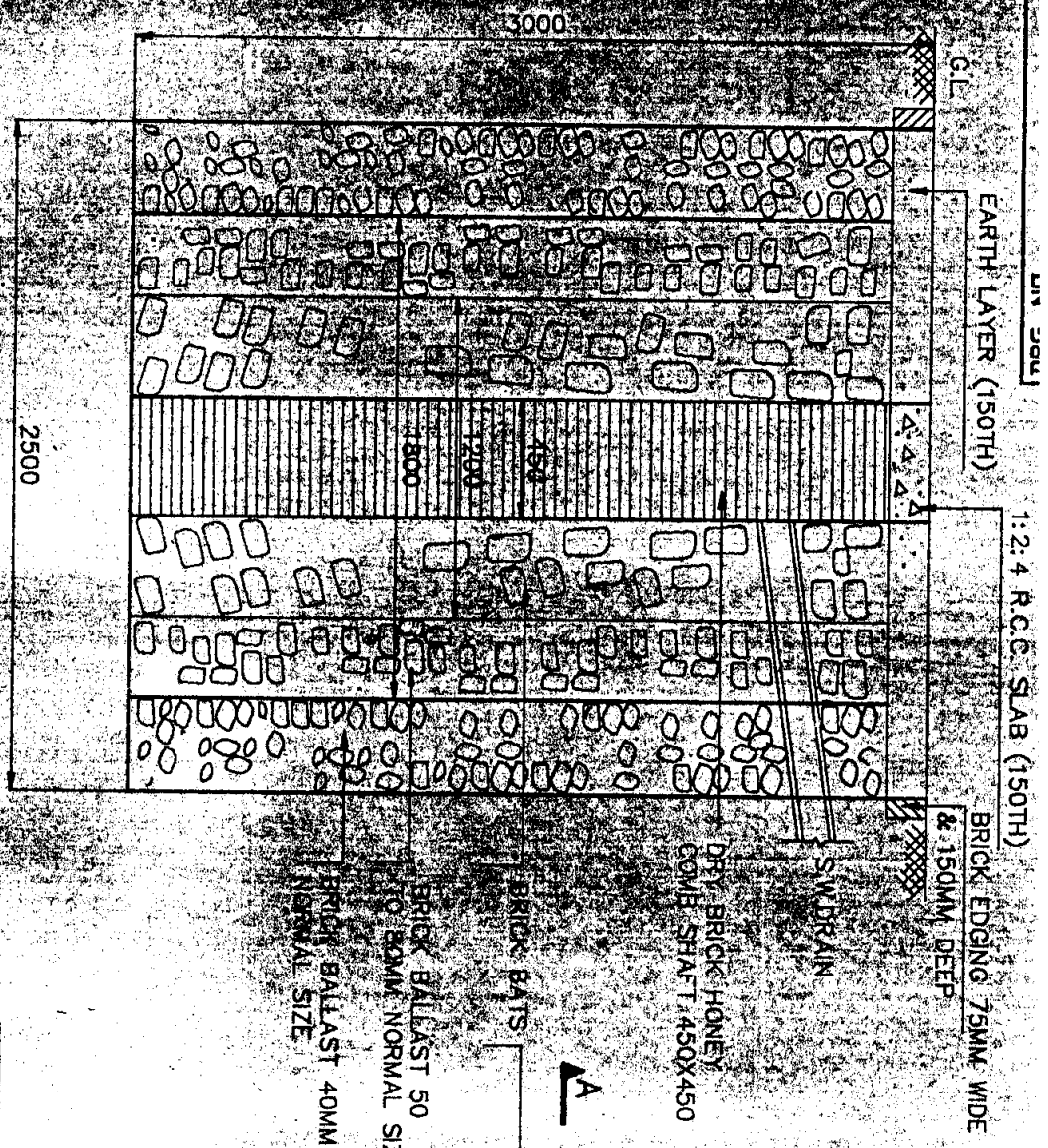

SECTION A-A

PLAN

REV.	DATE	ALTERED BY	CHECKED BY

TYPE OF PRODUCT		STANDARD	
OR		NAME OF CUSTOMER/PROJECT	
 BHARAT HEAVY ELECTRICALS LTD. HYDERABAD			
DEPT. AND CODE	SCALE	WEIGHT (KGS)	REF. TO ASSY DRA.
480	1:20		
TITLE	CAPP CODE	DRAWING NDL.	DATE
SOAK PIT DETAILS		3-38144-00003	22/10/15
SHEET NO. 1		NO OF SHEETS 1	

DRN. NO.	NAME	SIGN.	DATE	NOTE

REV. 001

1:2:4 R.C.C. SLAB (150TH)

BRICK EDGING 75MM WIDE & 150MM DEEP

2500 DIA

OFFICE COPY

2

3

of

THE INFORMATION ON THIS DOCUMENT IS THE PROPERTY OF BHARAT HEAVY ELECTRICALS LIMITED. IT MUST NOT BE USED DIRECTLY OR INDIRECTLY IN ANY WAY DETRIMENTAL TO THE INTEREST OF THE COMPANY

OFFICE COPY

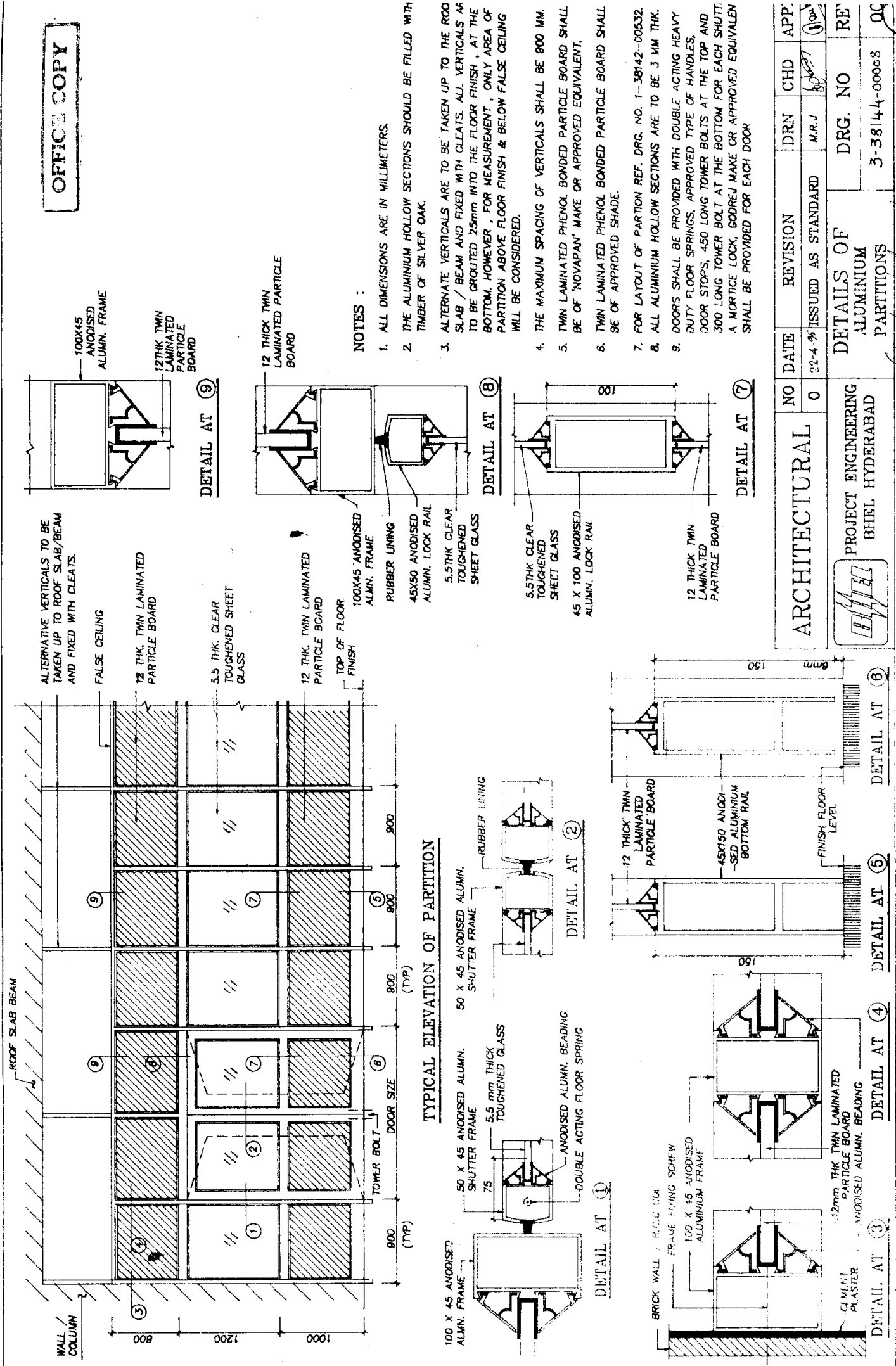

ARCHITECTURAL	NO	DATE	REVISION	DRN	CHD	APP.
	0	22-4-98	ISSUED AS STANDARD	M.R.J		
PROJECT ENGINEERING BHEL HYDERABAD		DETAILS OF ALUMINIUM PARTITIONS		DRG. NO	RE'	
				3-38144-00068		

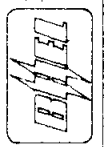

(ALL DIMENSIONS ARE IN MM)

60000-4718E-E DRG NO. ON '08

THE INFORMATION ON THIS DOCUMENT IS THE PROPERTY OF BHARAT HEAVY ELECTRICALS LIMITED. IT MUST NOT BE USED DIRECTLY OR INDIRECTLY IN ANY WAY DETRIMENTAL TO THE INTEREST OF THE COMPANY

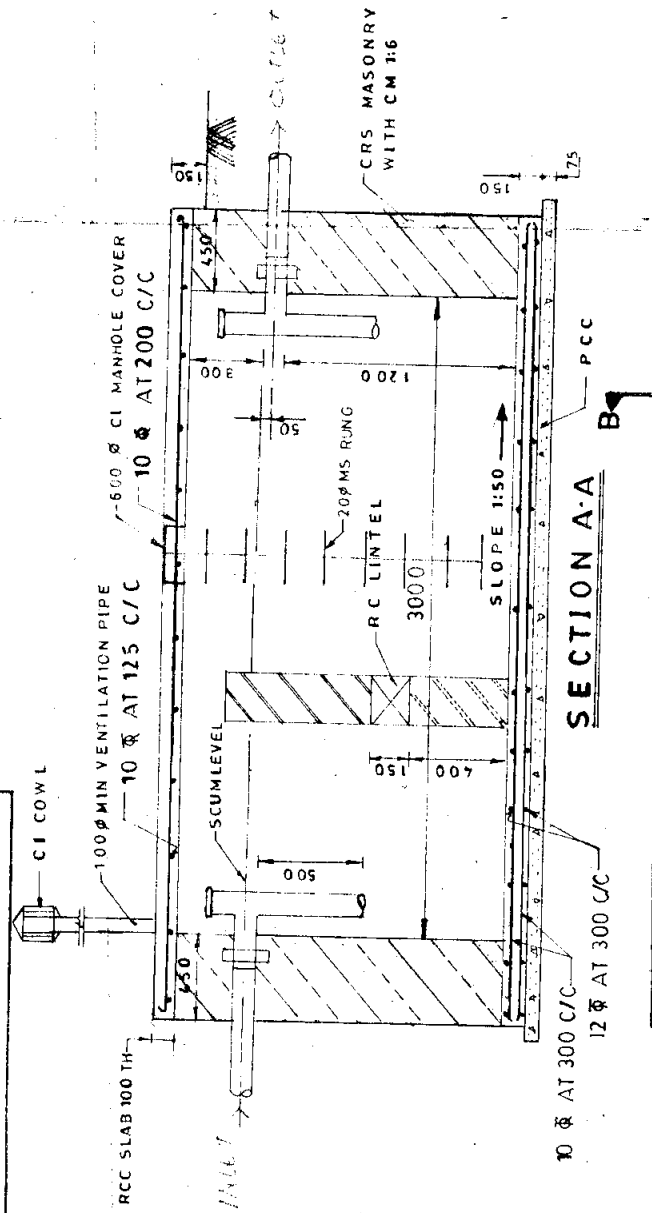

SECTION A-A

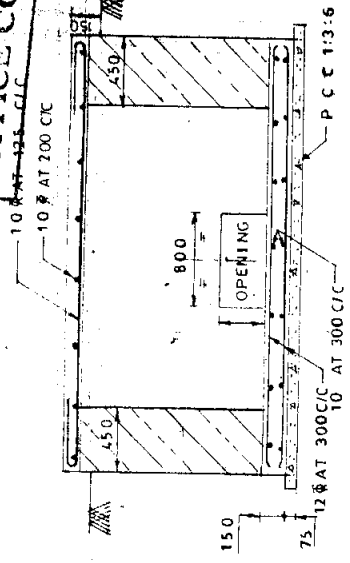

SECTION B-B

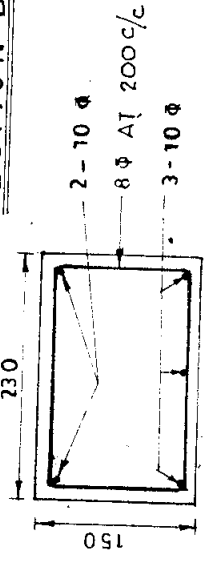

LINTEL BEAM DETAIL

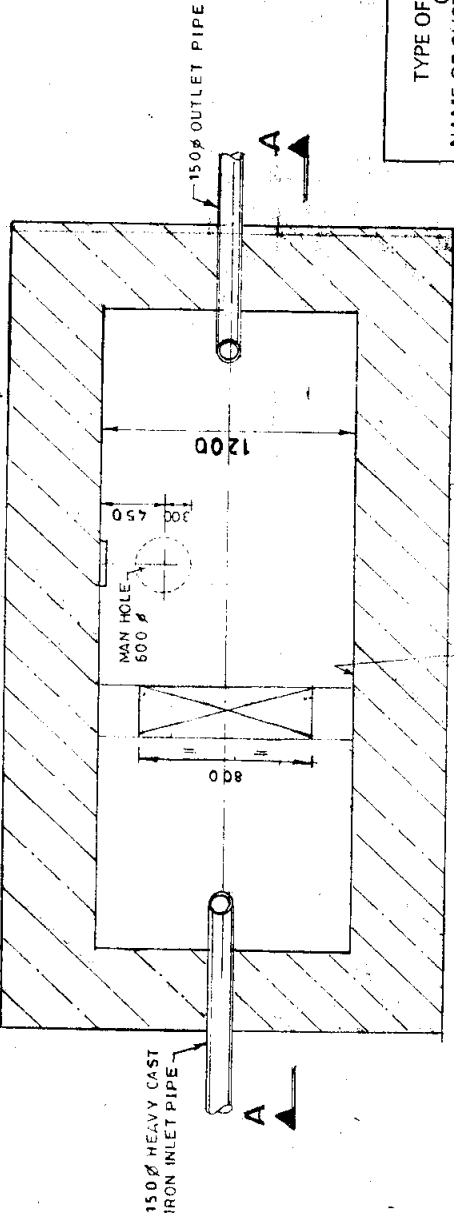

PLAN

NOTES  
1 ALL DIMENSIONS ARE IN MM U.S.

STP	71	29	31	34	45	55	56	58	UNIT WT.	65	72	ZONE
DRAWING NO.	VAR.	VAR.	VAR.	MATL. CODE	MATL. SPCN.	54	C	5	186	QTY.	71	9
28	CARD TYPE-1											

TYPE OF PRODUCT OR NAME OF CUSTOMER/PROJECT  
**STANDARD**  
BHARAT HEAVY ELECTRICALS LTD.  
HYDERABAD



DEPT. FIELD CODE	GRADE OF TOX. DIM. C/M/F	SCALE	WEIGHT (KG)	REF. TO ASSY. DRG.	DATE	NO. OF VAR.	NO. OF ITEMS
450	N.T.S	N.T.S			26/6/92	9/7/92	22/53/24
REV.	ALTERED	CHECKED	DATE	ZONE	REV.	DATE	ZONE
TITLE							DRAWING NO.
SEPTIC TANK (25 USERS)							3-38144-0009
CARD CODE							NO. OF SHEETS
37							00

**ARCHITECTURAL**

NO	DATE	REVISIONS	DRN	CHD	APPD
0	05/02/93	ISSUED AS STANDARD	<i>[Signature]</i>	<i>[Signature]</i>	<i>[Signature]</i>

THE INFORMATION ON THIS DOCUMENT IS THE PROPERTY OF HARAT HEAVY ELECTRICALS LIMITED. IT MUST NOT BE USED DIRECTLY OR INDIRECTLY IN ANY WAY DETRIMENTAL TO THE INTEREST OF THE COMPANY.

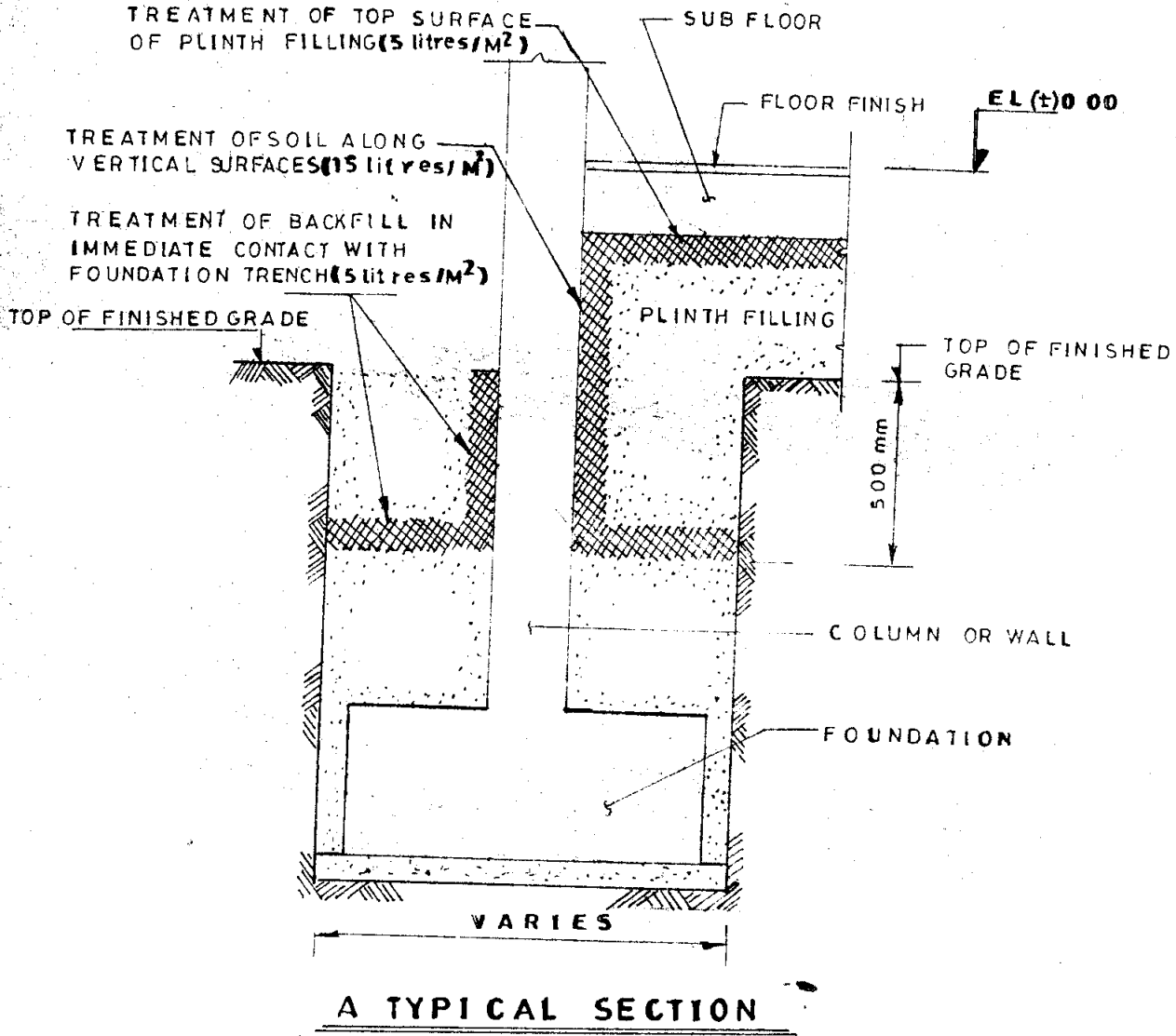

PROJECT ENGINEERING  
BHEL HYDERABAD

**ANTI-TERMITE  
TREATMENT**

DRAWING. NO:	REV
4-38144-00004	0

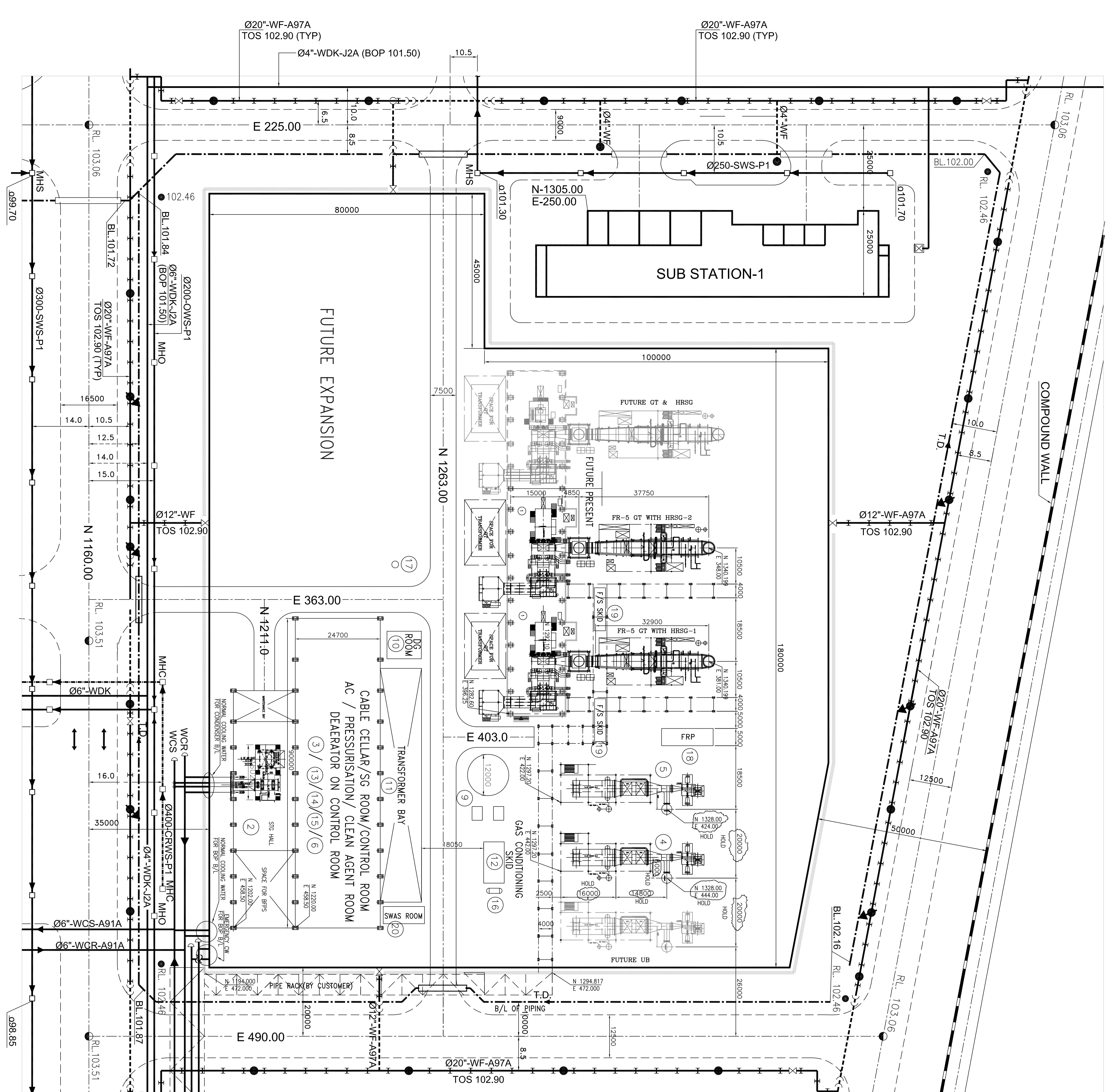
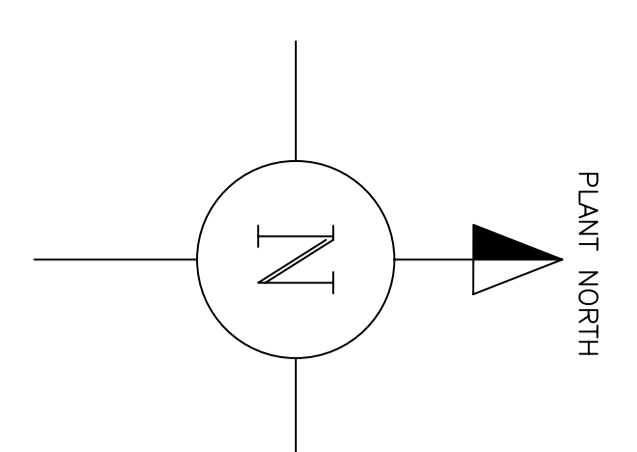

GENERAL DIMENSIONAL LIMITS, FITS & TOLERANCES AS PER HY0230261

REV.	DATE	ALTERED	ZONE
1	01/02/2010	JCS	1
2	01/02/2010	JCS	2
3	01/02/2010	JCS	3
4	01/02/2010	JCS	4
5	01/02/2010	JCS	5
6	01/02/2010	JCS	6
7	01/02/2010	JCS	7
8	01/02/2010	JCS	8
9	01/02/2010	JCS	9
10	01/02/2010	JCS	10
11	01/02/2010	JCS	11
12	01/02/2010	JCS	12
13	01/02/2010	JCS	13
14	01/02/2010	JCS	14
15	01/02/2010	JCS	15

**REFERENCE LEVELS OF FLOORS/FOUNDATIONS**

LEGEND:

- FTL: Finished Floor Level
- HPP: Highest Point and CRANE MOVEMENT AREA Level
- FGL: Finished Ground Level

STATUS: FOR APPROVAL

DATE: 01/02/2010  
 DRAWN BY: JCS  
 CHECKED BY: JCS  
 APPROVED BY: JCS

**REFERENCE DRGS.**

- OVERALL PLAN : 6907-010-1647-0001(TEL.DWG.)
- SCOPE DRG. FOR OPE : 6907-128-1647-1151(TEL.DWG.)

**NOTES:**

- ALL CO-ORDINATES ARE IN METERS.
- ALL DIMENSIONS ARE IN MM.
- FTL 99.5m CORRESPONDS TO SITE RL 102.56m(M/S EL. TO CONFORM THIS ELEVATION)

**COMPONENT :**  
 BRAHMAPUTRA CRACKER AND POLYMER LIMITED  
 BRAHMAPUTRA PETROCHEMICAL COMPLEX PROJECT  
 UTILITIES SYSTEM LEPPAKATA, ASSAM

**PROJECT :**  
 CAPTIVE POWER PLANT, LEPPAKATA

**CONSULTANT :**  
 SPTI ENGINEERS AND ARCHITECTS  
 BHARATI HEAVY ELECTRICALS LTD.  
 HYDERABAD

**CLIENT :**  
 BRAHMAPUTRA CRACKER AND POLYMER LIMITED  
 HYDERABAD

**SCALE :** 1:500

**TITLE :** PLOT PLAN

**DATE :** 01-02-2010

**DRAWING NO. :** 0-381-01-01107 01

**NO. OF SHEET :** 1

**EQUIPMENT LIST**

S.No.	DESCRIPTION	QTY
01	GT BUILDING	01
02	GT BUILDING	01
03	GT BUILDING	01
04	GT BUILDING	01
05	GT BUILDING	01
06	GT BUILDING	01
07	GT BUILDING	01
08	GT BUILDING	01
09	GT BUILDING	01
10	GT BUILDING	01
11	GT BUILDING	01
12	GT BUILDING	01
13	GT BUILDING	01
14	GT BUILDING	01
15	GT BUILDING	01
16	GT BUILDING	01
17	GT BUILDING	01
18	GT BUILDING	01
19	GT BUILDING	01
20	GT BUILDING	01
21	GT BUILDING	01
22	GT BUILDING	01
23	GT BUILDING	01
24	GT BUILDING	01
25	GT BUILDING	01
26	GT BUILDING	01
27	GT BUILDING	01
28	GT BUILDING	01
29	GT BUILDING	01
30	GT BUILDING	01
31	GT BUILDING	01
32	GT BUILDING	01
33	GT BUILDING	01
34	GT BUILDING	01
35	GT BUILDING	01
36	GT BUILDING	01
37	GT BUILDING	01
38	GT BUILDING	01
39	GT BUILDING	01
40	GT BUILDING	01
41	GT BUILDING	01
42	GT BUILDING	01
43	GT BUILDING	01
44	GT BUILDING	01
45	GT BUILDING	01
46	GT BUILDING	01
47	GT BUILDING	01
48	GT BUILDING	01
49	GT BUILDING	01
50	GT BUILDING	01
51	GT BUILDING	01
52	GT BUILDING	01
53	GT BUILDING	01
54	GT BUILDING	01
55	GT BUILDING	01
56	GT BUILDING	01
57	GT BUILDING	01
58	GT BUILDING	01
59	GT BUILDING	01
60	GT BUILDING	01
61	GT BUILDING	01
62	GT BUILDING	01
63	GT BUILDING	01
64	GT BUILDING	01
65	GT BUILDING	01
66	GT BUILDING	01
67	GT BUILDING	01
68	GT BUILDING	01
69	GT BUILDING	01
70	GT BUILDING	01
71	GT BUILDING	01
72	GT BUILDING	01
73	GT BUILDING	01
74	GT BUILDING	01
75	GT BUILDING	01
76	GT BUILDING	01
77	GT BUILDING	01
78	GT BUILDING	01
79	GT BUILDING	01
80	GT BUILDING	01
81	GT BUILDING	01
82	GT BUILDING	01
83	GT BUILDING	01
84	GT BUILDING	01
85	GT BUILDING	01
86	GT BUILDING	01
87	GT BUILDING	01
88	GT BUILDING	01
89	GT BUILDING	01
90	GT BUILDING	01
91	GT BUILDING	01
92	GT BUILDING	01
93	GT BUILDING	01
94	GT BUILDING	01
95	GT BUILDING	01
96	GT BUILDING	01
97	GT BUILDING	01
98	GT BUILDING	01
99	GT BUILDING	01
100	GT BUILDING	01

**PIPING INTERFACE AT BATTERY LIMITS**

S.No.	SERVICE	CO. ORIGINATES	REMARKS
01	WP STEAM	E 472000	AT ZONE F-10
02	DM WATER	E 472000	AT ZONE F-10
03	RETURN CONDENSATE	E 472000	AT ZONE F-10
04	STEAM LINES	E 472000	AT ZONE F-10
05	SEWAGE WATER	E 472000	AT ZONE F-10
06	WATER	E 472000	AT ZONE F-10
07	HP STEAM	N 1194000	AT ZONE F-10
08	HP STEAM	N 1194000	AT ZONE F-10
09	LP STEAM	N 1194000	AT ZONE F-10
10	EXPORT FEED WATER	N 1194000	AT ZONE F-10
11	HEAVY METAL AIR	N 1194000	AT ZONE F-10
12	STEAM AIR	N 1194000	AT ZONE F-10
13	STEAM WATER	N 1194000	AT ZONE F-10
14	WATER FOR THE CONDENSERS	N 1194000	AT ZONE F-10
15	WATER FOR THE CONDENSERS	N 1194000	AT ZONE F-10
16	WATER FOR THE CONDENSERS	N 1194000	AT ZONE F-10

(ALL DIMENSIONS ARE IN MM)

1.2 PIPE ELECTRODE

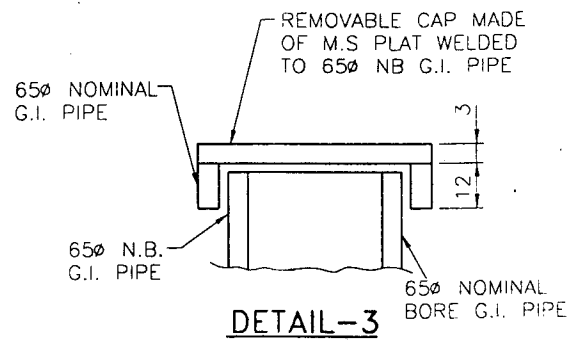
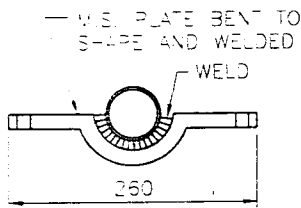
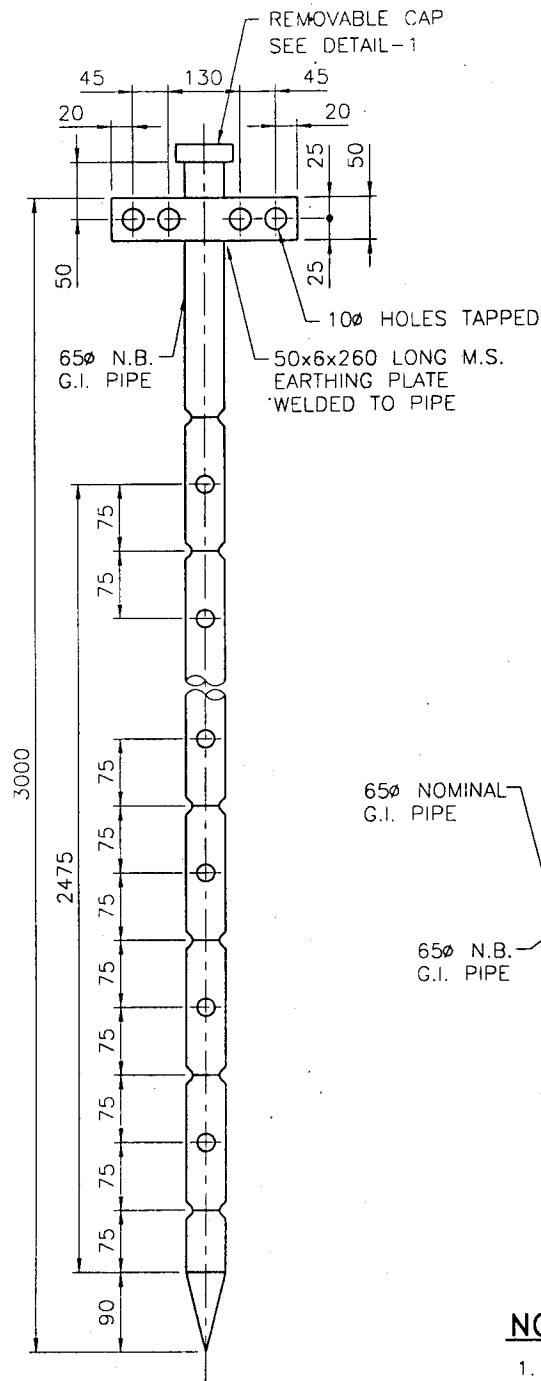

**NOTE:-**

1. PIPE ASSEMBLY SHALL BE HOT DIP GALVANISED AFTER FABRICATION
3. AS PER IS:3043 (LATEST REVISION)

COPYRIGHT AND CONFIDENTIAL

The information on this document is the property of BHARAT HEAVY ELECTRICALS LIMITED. It must not be used directly in any way detrimental to the interest of the company.



**PRODUCT STANDARD**  
**PROJECT ENGINEERING**

GT57191

REV No. 00

PAGE 10 OF 37

**1.1 EARTH ELECTRODE IN TEST PIT**

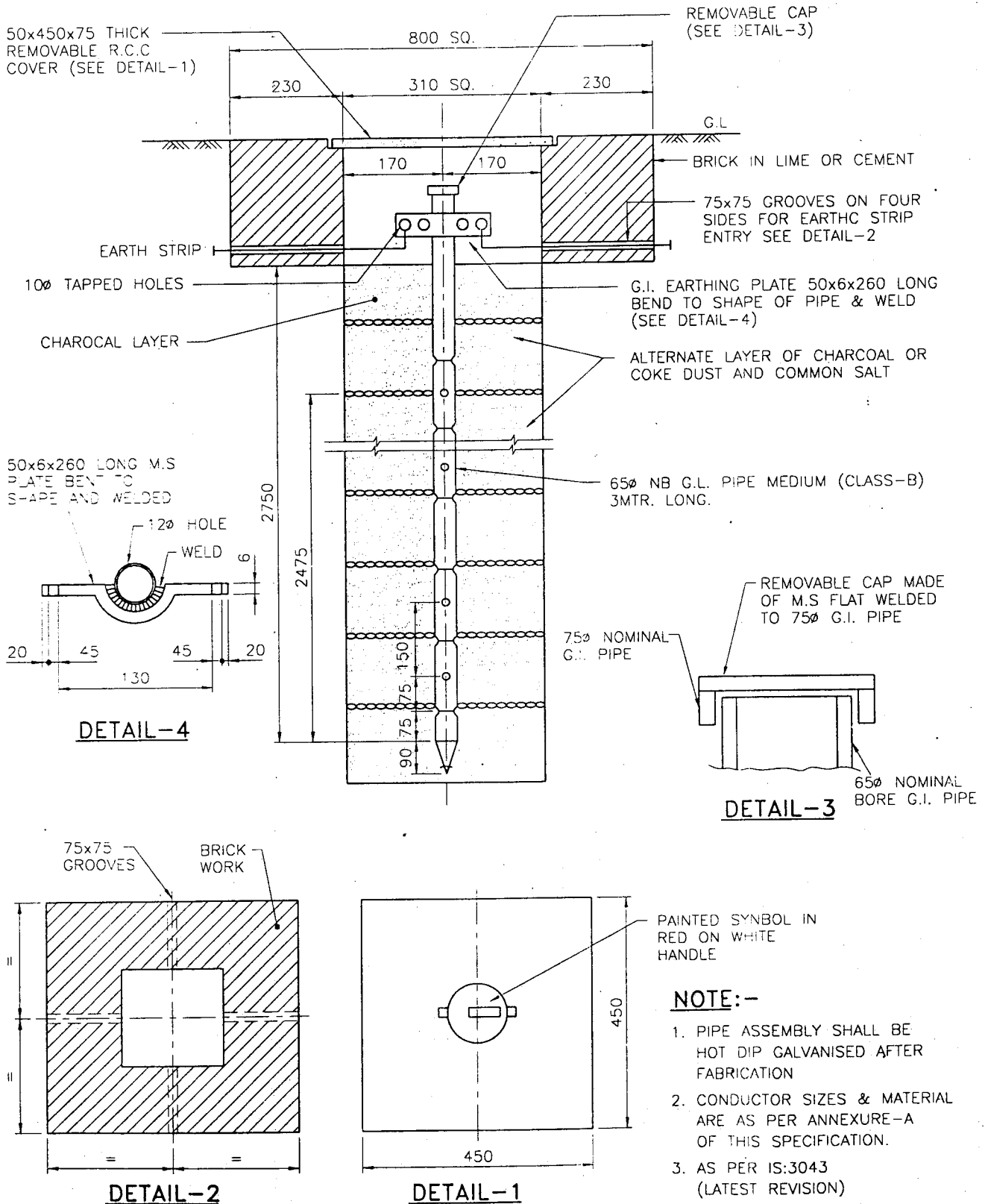

**NOTE:-**

1. PIPE ASSEMBLY SHALL BE HOT DIP GALVANISED AFTER FABRICATION
2. CONDUCTOR SIZES & MATERIAL ARE AS PER ANNEXURE-A OF THIS SPECIFICATION.
3. AS PER IS:3043 (LATEST REVISION)

COPYRIGHT AND CONFIDENTIAL  
 The information on this document is the property of BHARAT HEAVY ELECTRICALS LIMITED.  
 It must not be used directly in any way detrimental to the interest of the company.



**STANDARD TECHNICAL SPECIFICATION  
FOR GENERAL SCOPE**

PEDC/STD.SPEC/001  
REV 00

Page 1 of 3

HYDERABAD

**GENERAL SCOPE**

REV. NO.	PRAPARED	APPROVED	DATE

**COPYRIGHT AND CONFIDENTIAL**

The information on this document is the property of BHARAT HEVY ELECTRICAL LTD.It must not be used directly or indirectly in any way detrimental to the interest of the Company.



## STANDARD TECHNICAL SPECIFICATION FOR GENERAL SCOPE

PEDC/STD.SPEC/001  
REV 00

Page 2 of 3

HYDERABAD

- 1) These Specifications establish and define the material and constructional requirements for civil, structural and architectural works.
- 2) Method of measurement are indicated in these specifications. Where not so specified, latest version of IS: 1200 shall be applicable.
- 3) Providing and operating necessary measuring and testing devices and materials including all Consumables are included in the scope of work. No separate measurement or payment for testing the work shall be made but rates quoted for various items shall be deemed to include the cost of such tests which are required.
- 4) All materials shall be standard quality, manufactured by renewed concerns, conforming the Indian standards or equivalent and shall have "IS" mark as far as possible unless other wise approved by engineer in-charge prior to procurement and use. The contractor shall furnish manufacture's certificates, for the materials tested from an approval test house, if asked for by the engineer-in-charge. The costs of all test and the test certificates, shall be borne by the contractor. No separate payment shall be made for the testing. The Engineer –in-charge shall have the right to determine whether all or any of the materials are suitable. Any materials procured or brought to sight and not conforming the specifications and satisfaction of the Engineer-in-charge shall be rejected and the contractor shall have to remove the same immediately from sight at his own expenses and with out any claim for compensation due to such rejection.
- 5) Where ever referred to in third tender document, only the latest revision which shall be enforced in the completion of work of specifications, codes of practice and other publications of the Bureau of Indian Standards shall be applicable.
- 6) Wherever contractor executes civil and structural works involving building and equipment foundations, structural work or building pipe etc the following works are deemed to have been included in the quoted rates for various works.

1. Mark of center lines or foundations

2. Marking of top levels of foundations, floors etc and establishment of reference lines, bench marks on various floors, plat forms etc.

3. Preparation of "as built" scheme of structural foundation and indicating designed and achieved levels, center line and dimensions of pockets, position and level of anchor bolt etc.

- 7) In case of conflict amongst the provisions of schedule of rate specifications and drawings, all of them shall be read in conjunction with other and clarification shall be obtained from the Engineer-in- charge whose decision shall be final and binding.

Following procedure may generally followed

7.1 Description of items in schedule of rates shall be followed when provisions therein are different from those in specifications

7.2 Where the description of items doesn't call out for some specific requirement but the same are given in specifications, the specifications shall be followed, in addition to the requirements given in description of items



**STANDARD TECHNICAL SPECIFICATION  
FOR GENERAL SCOPE**

PEDC/STD.SPEC/001  
REV 00

Page 3 of 3

HYDERABAD

7.3 Where drawings call out for requirements different from or additional to those given item description and specifications, the decision of the Engineer-In-Charge shall be obtained as to what shall be followed.



HYDERABAD

**STANDARD TECHNICAL SPECIFICATION  
PROPERTIES, STORAGE & HANDLING OF  
COMMON BUILDING MATERIALS**

PEDC/STD.SPEC/02  
REV 00

Page 1 of 5

**PROPERTIES, STORAGE & HANDLING OF  
COMMON BUILDING MATERIALS**

REV. NO.	PRAPARED	APPROVED	DATE
00	MARINA	PMISHRA	30.10.09

**COPYRIGHT AND CONFIDENTIAL**

The information on this document is the property of BHARAT HEVY ELECTRICAL LTD.It must not be used directly or indirectly in any way detrimental to the interest of the Company.



HYDERABAD

## STANDARD TECHNICAL SPECIFICATION PROPERTIES, STORAGE & HANDLING OF COMMON BUILDING MATERIALS

PEDC/STD.SPEC/02  
REV 00

Page 2 of 5

### 1.00.0 Scope

The scope for this section is to specify the properties, storage and handling of Common building materials unless otherwise mentioned in drawings or Schedule items.

### 2.00.0 MATERIALS

#### a) Bricks

Bricks for general masonry work shall be conform to IS: 10 and for face Bricks work shall conform to the specifications in IS: 2691.

Bricks for general masonry work shall be of first class (Class A) quality, WellBurnt, of uniform size, shape and colour free cracks, flaws or nosules Or free lime and emit clear ringing sound when struck. Fractured surface Shall show uniform texture free from grits, lumps holes etc. Compressive Strength shall be  $75\text{kg}/\text{cm}^2$  minimum for common bricks and  $150/\text{kg}/\text{cm}^2$  Minimum for face bricks. Water for common bricks absorption after 24 Hours Immersion shall not exceed 15% by weight for common bricks and 12% For Face bricks. Dimensional tolerance shall not exceed 8% of the size shown in Drawing for common bricks and 3% for face bricks. All bricks shall have Rectangular faces and shape bricks shall be 6mm at the edges and 10mm For Corners. The bricks shall show no effluences after socking in water and In shade.

Each bricks shall have manufacturer's identification marks clearly marked on The frog. Representative samples shall be submitted and approved sample shall be retained by the of face bricks shall be limited to the range of samples submitted. Any brick not found the specification should be removed immediately from site at the contractor's own cost.

#### b) stone

All stones shall be from approved quarries. Hard, tough, durable compact Drained, uniform in texture and colour and free from decay, flaws, veins, Cracks and sand holes. The surface of freshly broken stone shall be bright, Clean and sharp and shall show uniformity of texture, without loose grains And free from any dull, chalky or earthy appearance. Stone showing mottled Colours shall not be used for face works. A stone shall not absorb more than 5 present of its weight of water after 24 hours immersion. The type of stone Shall be as specified on drawings and/or instructed by Engineer. Samples Shall be submitted by the contactor and approved samples shall be retained by By the engineer for comparison of bulk supply.

#### c) Lime



## STANDARD TECHNICAL SPECIFICATION PROPERTIES, STORAGE & HANDLING OF COMMON BUILDING MATERIALS

PEDC/STD.SPEC/02  
REV 00

Page 3 of 5

HYDERABAD

Lime shall be stone lime and conform to the specification Building lime IS: 712. Lime putty may be prepared from hydrated lime or quick lime. Hydrated lime shall be mixed with water to form putty and stored with Reasonable care to prevent evaporation for at least 24 hours before use. Quick Lime shall be slacked with enough water to make a cream passed through a No. 0 Sieve and then stored with reasonable care to prevent evaporation for At least 7 days before use.

### d) Cement

Cement used shall be ordinary Portland cement conforming to Code for Ordinary cement in IS: 8112 and shall be fresh when delivered. The contractor Shall submit the manufacture's certificate for each consignments of cement Procured to the contractor, the Contractor shall satisfy himself at the time of Taking delivery that the quality, quantity and freshness of cement are up to the Specified standards No. Shall be entertained and all rectification work on Account shall be done by the contractor at his own expense. If at any time, the Engineer feels that the work and send the samples of the cement to a testing Laboratory for standard tests and all expenses incurred thus shall be borne by the Contractor. The contractor shall else have no claim for this type of Suspension of work.

### e) Coarse Aggregates

Coarse aggregates shall be as per IS: 383 latest editions, consisting of hard, Strong and durable pieces of crushed stone and shall and be free organic or clay coatings and other impurities like disintegrated stone. Soft flaky particles etc. and Any other materials liable to affect the strength durability or appearance of Concrete.

Aggregates other than crushed stone conforming to the provisions of Specification may be used if permitted by the Engineer.

Washing of aggregates by approved means shall be carried out, if desired by The Engineer.

Grading of coarse aggregates shall generally conform to IS: 383 and shall be Such as produce dense concrete of the specified proportions and strength and of Consistency that will work readily into position without segregation.

### f) Sand

Sand shall be hard, durables, clean and free from adherent coating or organic matter and shall not contain clay balls or pellets, the sand shall be free from impurities such as iron pyrites. Alkalise, salts, coal, mica, shale or other laminated materials in such forms or quantities as to affect adversely the Harding, strength, durability or appearance of mortar. Plaster or concrete or to cause corrosions to any metal in contact with such mortar, plaster



**STANDARD TECHNICAL SPECIFICATION  
PROPERTIES, STORAGE & HANDLING OF  
COMMON BUILDING MATERIALS**

PEDC/STD.SPEC/02  
REV 00

Page 4 of 5

HYDERABAD

or concrete. All sand shall be properly graded. Unless otherwise directed by the Engineer all sand shall pass through IS Sieve NO < 240 and 15 to 30% of and for masonry mortar and 5 to 50% of sand for plaster shall pass through IS Sieve No 30. Sand for concrete shall conform to IS: 383.

**e) Water**

Water shall be clean, fresh and free from organise matters, acids or soluble salts And other deleterious substances which may cause corrosion, discolouration, Efflorescence etc.

**g) Reinforcement**

Reinforcement steel shall be clean and free from loose mill scales, dust, loose Rust, oil and grease or other coatings, which may impair proper, bond Structural Steel shall conform to IS: 226. Mild steel and medium tensile steel and medium Tensile steel bars and hard-drawn steel wire for concrete reinforcement shall Conform is IS: 432 Cold twisted steel bars shall conform to IS:1786 Hexagonal Wire netting shall conform to IS: 3150. All steel bars including and above 10mm Diameter shall be of tested quality. All wire netting shall be galvanised.

**3.00.0 STORAGE AND HANDLING OF MATERIALS.**

**a) Bricks**

Bricks shall not dumped at sits. They shall be stacked in regular tires. Even as They are unloaded, to minimise breakage and defacement of bricks. Bricks Selected for different situation of use in the work shall be stacked separately.

**b) Stones**

Stones shall be stored at site in manner approved by the Engineer. Dressed stone For wall facing, paving etc. shall be stored with special care to avoid Defacement of faces and edges or damp and rust stains.

**c) Lime**

Lime shall be in weatherproof sheds.

**d) Cement**

The cement shall be stored above the ground level in perfectly dry and watertight sheds. The bags shall be stacked in a manner so as to facilitate removal or first in first out basis. Any material considered defective by the Engineer shall not be used by the contractor and shall be removed from the Site immediately.



**STANDARD TECHNICAL SPECIFICATION  
PROPERTIES, STORAGE & HANDLING OF  
COMMON BUILDING MATERIALS**

PEDC/STD.SPEC/02  
REV 00

Page 5 of 5

HYDERABAD

**e) Coarse and Fine Aggregates**

Aggregates shall be stored on brick soiling or an equivalent platform so that they do not come in contact with dirt. Grass or any other injurious substances at any stage. Aggregate of different size shall be kept in separate stacks. If so desired by the Engineer aggregate from different sources shall be stacked separately with proper care to prevent intermixing.

**f) Reinforcement**

Reinforcement bars shall be stored off the ground and under cover if so desired by the Engineer. If necessary. A coat of cement wash shall be given to the bars to guard against rusting.



HYDERABAD

**STANDARD TECHNICAL SPECIFICATION  
FOR EARTHWORK IN EXCAVATION AND  
BACKFILLING**

PEDC/STD.SPEC/03  
2 REV 00

Page 1 of 19

**EARTHWORK IN EXCAVATION AND  
BACKFILLING**

REV. NO.	PRAPARED	APPROVED	DATE
00	MARINA	PMISHRA	00

**COPYRIGHT AND CONFIDENTIAL**

The information on this document is the property of BHARAT HEVY ELECTRICAL LTD.It must not be used directly or indirectly in any way detrimental to the interest of the Company.



HYDERABAD

## STANDARD TECHNICAL SPECIFICATION FOR EARTHWORK IN EXCAVATION AND BACKFILLING

PEDC/STD.SPEC/03  
2 REV 00

Page 2 of 19

### 1.0.0 SCOPE

This specification covers excavation in all types of soil, soft and decomposed rock not requiring blasting and rocks requiring blasting, shoring, dewatering, filling around foundations and to grade, compaction of fills and approaches, protective fencing, lighting, etc relevant to structures and locations covered under the scope of this contact.

### 2.00.0 GENERAL

#### 2.1.0 WORK TO PROVIDED FOR BY THE CONTRACTOR

The work to provided for by the contractor, unless specified otherwise. Shall include but not be the following.

- a) Furnish all labour, supervision, services including facilities as required under statutory labour regulations, materials, equipment, tools and plants, transportation, etc, required by the Engineer
- b) Prepare and submit working drawing showing the approaches, slope, beam, shoring, sumps for dewatering, including drains and outfall for drainage, space for temporary stacking of spoil, disposal area, fencing, etc and all other details as may be required by the Engineer.
- c) To carry out sampling and testing and submit to the Engineer, results of soil compaction tests if required by the Engineer to assess the degree of compaction.
- d) Construction, maintenance and removal after completion of Magazine of proper capacity as well as design for storing of explosives required for blasting work to be carried out scope of this tender.

#### 2.2.0 WORK TO PROVIDED FOR BY OTHERS.

No work under this specification will be provided by any agency other than the Contractor unless specifically mentioned elsewhere in the Contract

#### 2.3.0 CODES AND STANARDS.

All works under this specification, unless specified otherwise shall conform to the Latest revision and /or replacement of the following or any other Indian Standard Specifications and codes of practice. In case any particular aspect of work is no Covered specially by Indian Standard Specification any other standard practice as May be specified by the Engineer shall be followed: -

IS: 3664: Indian Standard for Safety Code for Excavation work.

IS: 1200: Indian standard Method of Measurement of Building and Civil Engineering Work, (Part-I): Earthwork.

IS: 4701: Indian standard Code of Practice for Earthwork on Canals

#### 2.4.0 CONFORMITY WITH DESIGNS.



HYDERABAD

## STANDARD TECHNICAL SPECIFICATION FOR EARTHWORK IN EXCAVATION AND BACKFILLING

PEDC/STD.SPEC/03  
2 REV 00

Page 3 of 19

The Contractor is to carry out the work as per the drawings issued to him and/ or Contractor's drawings which are approved by the Engineer and/or Engineer's instructions.

### 2.5.0 MATERIALS TO BE USED

#### 2.5.1 GENERAL

All material required for the work shall be of best commercial variety and approved By the Engineer.

#### 2.5.2 BORROW METERIAL.

Borrow material required for back-filling shall be excavated from approved locations and levels and shall consist of material, approved by the Engineer, free roots, Vegetations, decayed organic matter, harmful salts and chemicals, free from lumps and codes. If specified, clean graded sand free from harmful and deleterious Material from approved quarries, shall be as fill material.

### 2.6.0 QUALITY CONTROL

The contractor shall establish and maintain quality control for the various aspects of the work, method, materials and equipment used. The quality control operation shall Include but not be limited to the following items of work: -

- a) Lines, Levels and Grades: I) periodic surveys  
II) Establishment of markers, boards etc.
- b) Back- filling: I) Checking the quality of fill material  
II) Checking moisture content of the backfill  
III) Checking the degree of compaction

### 3.3.0 EXECUTION

#### 3.1.0 SETTING OUT

Within 15 days of award of Contract, the contractor will prepare and submit to the Engineer, detailed drawings of the excavation work as proposed to be executed by The Showing the diminutions as per drawings and specification adding his proposals of Slopes, shoring, approaches, dewatering sumps, beams, etc. On Receiving, approval From the engineer with modifications and corrections, if necessary, the Contractor Will set out the work from the control points furnished by the Engineering and fix Permanent point s furnished by the Engineer and fix permanent point and markers for case of future checking. These permanent points and markers for case of furnished by the engineer and fix permanent points and markers will be fixed at intervals prescribed by the Engineer and checked by the Engineer and certified by him after which the Contractor will proceed with the work. It should be noted that this checking by the Engineer prior to start of the carrying work will in no way



HYDERABAD

## STANDARD TECHNICAL SPECIFICATION FOR EARTHWORK IN EXCAVATION AND BACKFILLING

PEDC/STD.SPEC/03  
2 REV 00

Page 4 of 19

absolve the Contractor of responsibility of carrying out the work to true lines and levels and grades as per drawing and subsequent corrections. If necessary, free of cost to the Owner in case any errors are noticed in the Contractor's work at any stage.

### 3.2.0 INITIAL LEVELS

Initial level of the ground either in a definite grid pattern or as directed by the Engineer will be taken by the Contractor jointly with the Engineer over the original Ground prior to starting actual excavation work and after setting out. These initial Level will be used for preparing cross-sections for volume measurement or for Crosschecking the depths obtained from tape measurement.

All records of levels, measurements etc. and also any drawing, cross section etc. Made there from, shall be jointly signed by the authorised representative of the Contractor and the engineer before the commencement of and they shall from the Basis of all payments in future.

### 3.3.0 CLEARING AND GRUBBING, ETC.

The area to be excavated shall be cleared out of fences, trees, logs, stumps, bush, Vegetation, rubbish, slush, etc. and levelled up. Trees upto 300mm girth shall be Uprooted. Trees above 300mm girth to be cut, shall be approved by the engineer And then Marked. Felling of trees shall include taking out roots up to 600mm below ground level or 150mm below formation level whichever is lower. After the tree is cut and roots taken out the pot-holes formed shall be filled with good earth in 250mm layers and consolidated unless directed by the Engineer otherwise. The trees shall be cut in suitable pieces as instructed by the Engineer.

Before earthwork is started, all the spoil and unserviceable materials and rubbish Shall be burned or removed from the site to approved disposal areas as may be Specified. Ash shall be spread or removed. Useful materials, saleable timber, Firewood, etc, shall be the property of the Owner and shall be stacked properly at the worksite in a manner as directed by the Engineer.

### 3.4.0 CLASSIFICATION

All earthworks shall be classified under the following categories:

#### a) ORDINARY SOIL

This shall comprise vegetable or organic soil, turf, sand, loam, clay, mud, peat, black Cotton soil, soft shale or loose moorum, a mixture of these and similar material which Yields to the ordinary application of pick and shovel, rake or other ordinary digging implement. Removal or any other modular material having diameter in any one direction not exceeding 75mm occurring in such strata shall be covered under this category.



HYDERABAD

## STANDARD TECHNICAL SPECIFICATION FOR EARTHWORK IN EXCAVATION AND BACKFILLING

PEDC/STD.SPEC/03  
2 REV 00

Page 5 of 19

### **b) HARD SOIL.**

This shall include

- i) Stiff heavy clay, hard shale, or compact moorum, requiring grafting tool or pick or both and chovel, closely applied,
- ii) Gravel and cobble stone having maximum diameter in any one direction between 75 and 300mm,
- iii) Soiling of roads, paths, etc, and hard core,
- iv) Macadam surface such as water bound, and bitumen/ tar bound,
- v) Lime concrete, stone masonry in lime mortar and brick work in lime/cement Mortar, below ground level,
- vi) Soft conglomerate, where the stones may be detached from the matrix with Picks, and
- vii) Generally any material, which requires close application of picks, or scarifies to loosen and not affording resistance to digging greater than the hardest of any soil mentioned in (i) And (vi) above.

### **c) SOFT AND DECOMPOSED ROCK**

This shall include:

- i) Limestone, sandstone, late rite, hard conglomerate or other soft or Disintegrated rock which may be quarried or spilt with crowbar,
- ii) Unreinforced cement concrete, which may be broken up with crowbars or picks And stone masonry in cement mortar belowground level.
- iii) Boulders, which do not require blasting having maximum diameter in any Direction of more than 300mm, found laying loose on the surface or embedded In river bed, soil, talus, slope wash and terrace material of dissimilar origin, and
- iv) Any rock which in dry state may be hard, requiring blasting, but which when Wet becomes soft and manageable by means other than blasting.

### **d) HARD ROCK (requiring blasting)**

This shall include:

- i) Any rock or cement concrete for the excavation of which the use of mechanical plant or blasting is requiring.
- ii) Reinforced cement concrete (reinforcement cut trough but separated from the concrete) below ground level, and
- iii) Boulders requiring blasting.



HYDERABAD

## STANDARD TECHNICAL SPECIFICATION FOR EARTHWORK IN EXCAVATION AND BACKFILLING

PEDC/STD.SPEC/03  
2 REV 00

Page 6 of 19

### c) **HARD ROCK (blasting prohibited)**

Hard rock requiring blasting as described under (d) but where blasting is Prohibited for any reason and excavation has to be carried out by chiselling, Wedging or other agreed method.

In case any dispute regarding classification, the decision of the Engineer shall be final.

### 3.4.0 **EXCAVATION FOR FOUNDATIONS AND TRENCHES**

#### 3.5.1 **GENERAL**

All excavations shall be done to the minimum dimensions as required for safety and Working facility. Prior approval of the Engineer shall be obtained by the Contractor, In each individual case, for the method he proposes to adopt for the Excavations including dimension, side slopes, shoring, dewatering, disposal, etc. This approval, however, shall not in any way make Engineer responsible for any Consequent loss Damage. The excavation must be carried out in the most Expeditious and efficient Manner.

All excavation in open cuts shall made true to line, slopes and grades shown on the Drawing or directed by the Engineer. No material shall project within the dimension Of minimum excavation lines marked. Boulders projecting out of the excavated Surfaces shall be removed, if in the opinion of the Engineer they are likely to be a Hindrance to the workers.

Method of excavation shall be in every case subject to the approval of the Engineer And the Contractor shall ensure that stability and safety of the excavation, adjacent Structures, to be works.

The Contractor shall be in every case subject to the approval of the excavation and Safety of the workmen. If any slip occurs, the Contractor shall remove all slipped Material from the excavated pit.

All loose boulders, semi-detached rocks, not directly in excavation but so close to The Area to be excavated as to be liable, in the opinion of the Engineer, to fall or Otherwise endanger the workmen, equipment of the work, etc, shall be stripped Off Removed away from the areas of excavation. The method used shall be such as Not to Shatter or render unstable or unsafe the portion which was originally sound And safe any materials not requiring removal as contemplated in the work, but Which In the Option of the Engineer, is later to become loose or unstable shall Also be Promptly and satisfactory directed by the Engineer.

Prior starting the excavation, the ground level at the location shall be checked Jointly With the Engineer.

The rough excavation may be carried unto a maximum depth of 150mm above the



HYDERABAD

## STANDARD TECHNICAL SPECIFICATION FOR EARTHWORK IN EXCAVATION AND BACKFILLING

PEDC/STD.SPEC/03  
2 REV 00

Page 7 of 19

Final level. The balance shall be excavated with special care. If directed by the Engineer, soft and undesirable spots shall be removed even below the final level. The extra excavation shall be filled up as instructed by the Engineer and the Contractor shall be paid for the extra excavation and the filling appropriate item Rates.

If the excavation is done to a depth greater than shown on the drawing, or directed By The Engineer, due to the Contractor's fault, the excess shall be filled unto the Required level at the latter's cost (with cement concrete not leaner than 1:4:8 Ordinary Concrete or richer) as directed by the engineer in each individual case.

Information of rock requiring blasting, those over cuts which are unavoidable will be Made unto ordinary cement concrete 1:2:4 which will be paid for under appropriate rate, provided this over cut is not due to negligence of the contractor. The decision of the Engineer as to the admissibility of such over cut for payment will be final. All excavated materials such hard rock, boulders, bricks, dismantled concrete blocks, etc. Shall be stacked separately as directed by the Engineer and shall be the property of the Owner.

### 3.5.2 EXCAVATION IN ORDINARY SOIL, HARD SOIL AND SOFT AND DECOMPOSED ROCK

The excavation in ordinary soil, soft and decomposed rock will be carried out as per the approved proposal, modified and corrected where necessary by the Engineer. The work will be carried out in a workman like manner without endangering the safety of nearby structure/ services or works wnd without causing hindrance to other activates in the area. As the excavation reaches the required dimensions, lines, levels and the grades, the work will be carried out carefully to avoid any over- excavation. On completion, the work will be finally checked and approved by the Engineer. In certain cases, where deterioration of the ground, upheaval, slips etc. are expected the engineering may order to suspend the at any stage and instruct the Contractor to carryout the balance work just before the foundation work of the structure can be started. No extra will be paid to the Contractor for such unviable temporary suspension of work.

### 3.5.3 EXCAVATION IN HARD ROCK

In case where excavation, both in ordinary soil and hard rock, are involved, the Ordinary soil comprising of soft, hard and dense soil (including literate formation) And rock including weathered rocks, lateritic rocks, etc. Which can be excavated Without blasting, shall be completely stripped off and the levels of the hard rock Wall be taken to be enable measurements. Further work in hard shall be resumed Clearance from the Engineer. Personal deployed for track excavation shall be Protected from all hazards such as loose rock/boulder rolling down and from general Slips of excavated surfaces. Where the excavated surface is such that it is not stable Against sliding, necessary from the excavated surfaces is such that it is not stable Against sliding, necessary supports, props, bracing or bulkheads shall be provide and Maintained .

In case where blasting, though otherwise required, is prohibited for any reasons, the



HYDERABAD

## STANDARD TECHNICAL SPECIFICATION FOR EARTHWORK IN EXCAVATION AND BACKFILLING

PEDC/STD.SPEC/03  
2 REV 00

Page 8 of 19

Excavation shall be carried out by chiselling, wedging or any other approved Method and payment appropriate to blasting shall be made, unless otherwise Mentioned in the Schedule.

### 3.5.4 BLASTING

#### 3.5.4.1 GENERAL

Storage, handling and use of explosives shall be governed by the current explosive Rules laid down by the state Governments. The Contractor shall ensure that these Rules are strictly adhered to. The following instruction, wherever found in variance With the variance with the above rules, shall be considered as superseded by the Above rules.

No child under the age of 16 and no person who is in a state of intoxication shall be allowed to enter the premises where explosives are stored not they Be allowed to handle the explosives.

#### 3.5.4.2. STORAGE OF EXPLOSIVE:

Storage of explosive shall be governed by the current explosive rules. Explosive shall be stored in aclean, dry, well ventilated magazine to be specially built for the purpose. Under no circumstances should a magazine be erected within 400mm of the actual work site or any source of fire. A space surrounding the magazine shall be fenced in. the ground inside the fence shall be kept class and free from tress, bushes etc. the admission ti this fence without permission of the officer-in-charge. The clear space between the fence and the magazine shall. shall not be less than 90m. The magazine shall be perfectly well drained.

Two lightning conductors shall be provided to the magazine, one at each end. The Lightning conductors shall be once in every year.

Fuses and detonators shall be stored in separate magazines. However, detonators can be kept in an annexe adjoining the magazines. However, provided that their number does not exceed 25,000 and that the annexe is so constructed that not less than 60cm masonry and 100cm of air space shall intervene between any detonators in such annexe and not to be opened in a magazine. Cases containing explosives are not to be opened in a magazine. Explosives in open cases are not to be received into a magazine. Explosives which appear to be in damaged or dangerous condition are not to be kept in any magazine, but must be removed without delay to a safe distance and destroyed.

Artificial light is to be allowed in any magazine. No smoking shall be allowed within 100m of a magazine.

Magazine shoes without nails shall be used while entering the magazine.



HYDERABAD

## STANDARD TECHNICAL SPECIFICATION FOR EARTHWORK IN EXCAVATION AND BACKFILLING

PEDC/STD.SPEC/03  
2 REV 00

Page 9 of 19

The mallets, levers, wedges etc, for opening barrels or cases are to be of wood. Inside a magazine the cases of explosives are to be carried by hand and shall not be rolled or dragged. Explosives, which have been issued and returned to the magazine are to be issued first, otherwise those which have been longest of cases in store are to be issued first.

Cases of explosives must be kept clear of the walls and floors for free circulation of air on all sides, special care is to be taken to kept the floor free from grains of powder of portions of explosive matter fallen on the floors due to leakage of cases etc.

The magazine shall not be opened during any duststorm or thunderstorm nor any person shall be allowed in the vicinity of the magazine.

All magazines shall be officially inspected at definite intervals and a record kept of the results of such inspections.

### 3.5.4.3. Carriage of Explosive

Detonators and explosives shall be transported separately to the blast site. Explosives shall be kept dry and away from the direct rays of the sun, naked lights, steam pipes or heated metal and other sources of heat. Before explosives are removed, each cage or package is to be carefully examined to ascertain that it is properly closed and shows no sign of leakage.

No persons except the driver shall be allowed to travel on a vehicle conveying Explosives. No carriage or vessel shall be used for transporting explosives unless all iron or steel therein with which a package containing any explosive is likely to Come or other suitable material. No lights shall be carried on the vehicle carrying Explosives.

No operation contracted with the leading, unloading and handling of explosives Shall be conducted after sunset.

### 3.5.4.4 USE OF EXPLOSIVES

The contractor shall appoint an agent who shall personally superintend the firing And All operations connected therewith. The contractor Shall Satisfy himself that the person so appointed is fully acquainted with the Responsibilities imposed on him.

Holes for charging explosives shall be drilled with Pneumatic drills, the drilling Pattern being so planned that the rock pieces after blasting will be suitable for Handling.

The hole diameter shall be of such a size that cartridges can easily pass down them And undue force is not required during charging. Charging operations shall be Carried out by or under the personal supervision of the shot firer. Wrappings shall neve be removed from explosive cartridges. Only wooden rods shall be used for



HYDERABAD

## STANDARD TECHNICAL SPECIFICATION FOR EARTHWORK IN EXCAVATION AND BACKFILLING

PEDC/STD.SPEC/03  
2 REV 00

Page 10 of 19

Loading and steaming shot holes. Only one cartridge at a time shall be inserted and gently passed home with the wooden tamping rod.

Only such quantities of explosives as are required for the particular amount of work to be done shall be brought to the works. Should any surplus remain when all the holes have been charged, it shall be carefully removed to a point at least 300m from the firing point.

The explosives shall be fired by means of an electric detonator placed inside the cartridge. For simultaneous firing of a number of charges the electric detonators shall be connected with the exploder through the shot firing cable in a simple series circuit. Due precautions shall be taken to keep the firing circuit insulated from the ground, bare wires, rails pipes or any other path of stray current and to keep the lead wires short circuited until ready to fire. Any kinks in detonator leading wire shall be avoided.

For simultaneous firing of a large number of shot holes, use of cordtex may be done. Cordtex shall be initiated by electric detonator attached to its side with adhesive tape, connecting wire or string.

All connection shall be made by authorised shot firer himself. The shot firing cable shall not be dragged along the ground to avoid possible damage to the insulation. The shot firing cable shall be tested for continuity and possible short circuiting before it is used each time.

The shot firer shall always carry the exploder handle on his person until he is ready to fire shots. The number of shots fired at a time shall not exceed the permissible limits.

Blasting shall be carried out at certain specified times to be agreed jointly by the Contractor and the Engineer.

Before any blasting is carried out. It shall be ensured that all workmen, vehicles and equipment on the site are cleared from an area of minimum 300 meters radius from the firing point, or as required by statutory regulation, at least ten minutes before the time of firing by sounding a warning siren. The area shall be encircled by red flags.

At least five minutes after the blast has been fired in case of electric firing or as stipulated in the regulations the authorised shot firer shall return to the blast area and inspect carefully the work and satisfy himself that all charged holes have exploded. Cases of misfired unexploded charges shall be remedied by drilling a parallel fresh hole not less than 600mm from the misfired hole and by exploding new charges. The authorised shot firer shall be present during removal of the debris liable to contain unexploded explosive near the misfired hole. The workmen shall not return to the site of firing until at least half an hour after firing.

When blasting is conducted in the neighbourhood of roads, structures, buildings etc. controlled blasting has to be carried out by drilling shallow shot holes and filling the same with light charge of explosives.



HYDERABAD

## STANDARD TECHNICAL SPECIFICATION FOR EARTHWORK IN EXCAVATION AND BACKFILLING

PEDC/STD.SPEC/03  
2 REV 00

Page 11 of 19

Adequate safety precautions as per building bye-laws, safety code, statutory regulations etc. shall be taken during blasting operations.

### 3.5.5 DISPOSAL

The excavated spoil will be disposed of in any or all the following manners.

- a) By using it for backfilling straightway.
- b) By stacking it temporarily for use in back filling at a later date during execution of the Contract.
- c) I) By either spreading, or  
ii) Spreading and compacting at designated disposal areas.
- d) By selecting the useful material and stacking it neatly in areas designated by the Engineer for use in backfilling by some other agency.

### 3.5.6 DISPOSAL OF SURPLUS

All surplus material from excavation shall be carried away from the excavation site to designated disposal area selected by Engineer.

All good and sound rock excavated from the pits and all assorted materials of dismantled structures shall be the property of the owner and if the Contractor wants to use it, he shall have to obtain it from the Engineer at a mutually Agreed rate for the same.

All sound rock and other assorted materials like excavated bricks, etc shall be stacked separately and shall be measured in stacks deducting 50% volumetric Measure for voids.

### 3.5.7 PROTECTION

The Engineer shall be notified by the contractor as soon as the excavation is Expected to the completed within a day so that it may be inspected by him at the Earliest. Immediately after approval of the engineer, the excavation must be Covered up in the shortest possible time. But, in no case the excavation shall be Covered up or worked On before approval and measurement by the Engineer. Excavated material shall be placed beyond 1.5 metres from the edge of the pit or Trench or half the depth of the pit or trench whichever is more or further away if Directed by the Engineer.

Excavation shall not be carried out below the foundation level of structure close by until required precautions have been taken.

Adequate fencing is to be made enclosing the excavation.

The Contractor shall protect all under- ground services exposed by excavation. The



HYDERABAD

## STANDARD TECHNICAL SPECIFICATION FOR EARTHWORK IN EXCAVATION AND BACKFILLING

PEDC/STD.SPEC/03  
2 REV 00

Page 12 of 19

Contractor shall also divert all surface drains, etc. affected by the excavation to  
Maintain the working area neat and clean.

### 3.5.8 DEWATERING

All excavations shall be kept free of water and slush. Grading in the vicinity of  
Excavations shall be controlled to prevent surface water running into excavated  
Areas. The Contractor shall remove by pumping or other means approved by the  
Engineer any water inclusive of rainwater and subsoil water accumulated in  
Excavation and keep the trench dewatered until the construction of foundation  
Structure and backfilling are complete in all respects. (Expect where such separate  
Payment will be made.) Sumps made for dewatering must be kept clear of the  
Foundations. Method of pumping shall be approved by the Engineer but in any  
Case, the pumping arrangement shall be no movement of subsoil or blowing in due  
To Differential head of water during pumping.

If necessary, the Engineer may the contractor to Contractor to continue dewatering  
Beyond his original or extended contract period in which case will be paid  
Separately for dewatering as terms mentioned elsewhere under payment and  
Measurement, provided the contractor has completed all the work satisfactorily

### 3.5.9. TIMBER SHORING

Timber shoring made out of approved quality of timber shall be 'close' or 'open'  
Type, depending on the nature of soil and the depth of pit or trench and the type of  
The contractor to take all necessary steps to prevent the sides of  
Trenches and pits from collapsing.

#### 3.5.9.1 CLOSE TIMBERING

Close timbering shall be done by completely covering the sides of the trenches and  
Pits generally with short, upright members called 'polling board'. These shall be of  
Minimum 250x40 mm sections as directed by the Engineer. The boards shall  
generally be placed in pairs, one board on each side of cutting, and shall be apart by  
Horizontal walers of strong wood at maximum 1.2 metres spacing, cross struts shall  
depend of the trench or pit.

In case where the soil is very soft and loose, the boards shall be placed horizontally  
against the sides of the excavation and supported by vertical walers, which shall be  
strutted to similar timber piece on the opposite face of the ground. No portion of the  
sides shall be taken into the ground. No portion of the vertical side of the trench or  
pit shall remain exposed, so that the earth is not libel to slip out.

The withdrawal of the timber shall be done very carefully to prevent the collapse of



HYDERABAD

## STANDARD TECHNICAL SPECIFICATION FOR EARTHWORK IN EXCAVATION AND BACKFILLING

PEDC/STD.SPEC/03  
2 REV 00

Page 13 of 19

the pit or trench. It shall be started at one end and proceeded systematically to the other end. Concrete or masonry shall not be damaged during the removal of the timber. No claim shall be entertained for any timber which cannot be withdrawn and is lost or buried.

### 3.5.9.2 OPEN TIMBERING.

In the case of open timbering, the entire surface of the side of trench pit is not required to be covered. The vertical board of minimum 250mm width and minimum 40mm depth shall be spaced sufficiently apart to leave unsupported strips of maximum 500 mm average width. The detailed arrangement, sizes of the timber and the distances apart shall be subject to the approval of the Engineer. In all other respects, specification for close timbering shall apply to open timbering.

### 3.10.0 TREATMENT OF SLIPS

The Contractor will take all precautions to avoid high surcharges and provide proper surface drainage drainage to prevent flow of water over the sides. These precautions along with proper slopes, berms, shorting and control of ground water should cause no slips to occur. If however slips do occur due to causes beyond the control of the contractor, the same shall be removed by him and payment shall be made to him on appropriate item rate of earthwork. Slips caused due to negligence of the Contractor will be cleared and back-filled later by him at his own expenses.

### 3.7.0 BACK FILLING

#### 3.7.1 GENERAL

The material used for backfilling shall consist of material, approved by the Engineer obtained directly from nearby areas where excavation work by the same agency is in Progress, from temporary stacks of excavated spions or from borrow pits from Lumps and clods, roots and vegetations, harmful salts and chemicals, organic Materials, etc.

In certain locations, the Engineer may direct sand fillings. The sand should be Cleaned, well graded and be of quality normally acceptable for use in concrete.

#### 3.7.2 FILLING AND COMPACTION IN PITS AND TRENCHES AROUND STRUCTURES

As soon as the work in foundations has been accepted and measured, the spaces Around The foundations structures in pits and trenches shall be cleared of all debris, brick bats, Mortar droppings etc, and filled with earth in layers not exceeding 250mm in loose Thickness each layer being watered, rammed and properly compacted to the Satisfaction of the Engineer. Earth shall be rammed with approved mechanised. Usually, no manual compaction shall be allowed unless specifically permitted by



HYDERABAD

## STANDARD TECHNICAL SPECIFICATION FOR EARTHWORK IN EXCAVATION AND BACKFILLING

PEDC/STD.SPEC/03  
2 REV 00

Page 14 of 19

the Engineer. The final surface shall be trimmed and levelled to proper profile as Desired by the Engineer.

Since the degree of compaction depends on the moisture content of the soil, a close watch should be kept on it and corrections to optimise the moisture content.

### 3.7.3 PLINTH FILLING

The plinth shall be filled with earth in layers not exceeding 250mm in loose Thickness, watered and compaction machine or manually, if specifically permitted By the Engineer. When the filling reaches the finished level, the surface shall be Flooded with water for at least 24 hours, allowed to dry and the rammed and Compacted, in order to avoid any settlement at a later stage. The finished level of The following shall be trimmed to the slope intended to be given to the floor.

### 3.7.4 FILLING IN TRENCHES FOR WATER PIPES AND DRAIN

Earth used for filling shall be free from salts, organic or other foreign matter. All Clods of earth shall be broken or removed. Where excavated material is mostly Rock, the boulders shall be broke into pieces not bigger than 150mm size in any Direction, mixed with fine material consisting of disintegrated rock, moorum or Earth as available, so as to fill up the voids as far as possible and then the mixture Used for filling.

Filling in trenches for pipes and drains be commenced as soon as the joints of pipes And drains have been tested and passed.

Where the trenches are excavated in soil, the filling shall be done with earth on the Sides and top of pipes in layers not exceeding 150mm, watered, rammed and Compacted taking care that no damage is caused to the pipe below.

In case of excavation of trenches in rock, the filling unto a depth of 300mm or the Diameter of the pipe whichever is more, above the crown of pipe or barrel shall be Done with fine material such as earth, moorum, disintegrated rock or ash according To the availability at site. The remaining filling shall be done with rock filling of Boulders of size not exceeding 150mm mixed with fine material as available to fill Up the voids, watered, rammed and compacted.

### 3.7.5 FILLING IN DISPOSAL AREA

Surplus material from excavation which is not required for backfilling will be Disposed of in disposal areas. The spoil shall not be dumped haphazardly but Should be spread in layers approximately 250mm thick when loose and compacted With the help of compacting equipment. In wide areas rollers will be employed and Compaction done to the satisfaction of the Engineer as the optimum moisture Content, which shall be checked and controlled by the Contractor.



HYDERABAD

## STANDARD TECHNICAL SPECIFICATION FOR EARTHWORK IN EXCAVATION AND BACKFILLING

PEDC/STD.SPEC/03  
2 REV 00

Page 15 of 19

In certain cases the Engineer may direct disposal without compaction which can be Done by typing the spoils from a high bench neatly maintaining always a proper Level and grade of the bench.

### 3.8.0 APPROCHES AND FENCING

The Contractor should provide and maintain approaches for workmen and for Inspection, the roads and approaches around the excavation pits should be kept Clear at all times so that there is no hindrance to the movement of men, material And equipment of various agencies connected with the project. Sturdy and elegant Fencing is to be provided around the top edge of excavation as well as the bottom Of the filling at the surplus disposal area where dumping from a high bench is in Progress.

### 3.9.0 LIGHTING

Full-scale area lighting is to be provided if night work is permitted or directed by The Engineer. If no night work is in progress, red warning lights should be provided At the corners of the excavated pit and the edges of the fill.

### 4.0.0 TESTING AND ACCEPTANCE CRITERIA

#### 4.1.0 EXCAVATION

On completion of the excavation, the dimensions of the pits will be checked as per The drawings after the pits are completely dewatered the work will be accepted After all undercuts have been set right and all over excavations filled back to Required lines, levels and grades by compacted earth, as directed by the Engineer At the Contractor's cost. The choice of grade of concrete will be a matter of unfettered discretion of the Engineer. Over excavation of sides will be made good free of cost by the contractor while carrying out the back filling. The excavation work will be accepted after the above requirements are fulfilled and all temporary Approaches encroaching inside the required dimension of the excavation have been Removed.

#### 4.2.0 BACK FILLING

The degree of compaction required will be as the per the stipulation laid down in IS: 4701, if not otherwise mentioned in the Schedule and the actual method of Measuring the compaction achieved will be as decided by the Engineer. Is Satisfied With the degree of compaction achieved.

### 5.0.0 INFORMATION TO BE SUBMITTED

#### 5.1.0 WITH TENDER



HYDERABAD

## STANDARD TECHNICAL SPECIFICATION FOR EARTHWORK IN EXCAVATION AND BACKFILLING

PEDC/STD.SPEC/03  
2 REV 00

Page 16 of 19

Detail of equipment proposed to be used for excavation, back filling and Compactions have to be submitted along with the tender.

### 5.2.0 AFTER AWARD

After award of the Contractor the successful tender shall submit the following for Approved and adoption

a) Within 30days of award of the Contractor, the Contractor shall submit a detailed Programme of the work as proposed to be executed giving completion dates of Excavation of the various foundations and the time required for back-filling and Compaction after completing the foundation for structure. In case the earthwork Contractor is also the agency for the foundation work, the Earthwork programme is To be contracted with the foundation programme. The programme should also show How the excavation and back-filling quantities will be balanced, minimising Temporary stacking of spoils. It is to be noted that Engineer even after initial Approval of the programme, may instruct to enhance or retard the progress of Foundations without attracting any claims from the Contractor. The initial Programme being submitted by the Contractor should have sufficient flexibility to Take care of such reasonable variations.

b) Within 15days of award, the Contractor shall submit showing details of slopes, Shorings, approaches, sump pits, dewatering lines, fencing etc, for approval of the Engineer for adoptions.

### 6.00 RATES

The rates for the items shall include cost of all materials consumed in the works, Hire Charges of materials, tools and plant, cost of labour, insurance, all transport, Taxes, Royalties, security and safety arrangements, supervision, profit etc. The rates of Excavation shall be also include the cost of dewatering and stacking the Excavated Spoils properly within a lead of 30 m unless otherwise mentioned in the Schedule of items.

The Contractor will have to give a rebate if the excavated earth is directly used for Back-filling.

Where back- filling is to be done with sand, it shall be of good quality from quarries Approved by the Engineer. The rate shall include all operations including the cost Of sand.

In cases the Contractor is required to continue dewatering of the excavated pits Beyond of the contract, original or extended, he will be paid separately for it as the Schedule of items only for the period beyond the final terminal date of the contact. The rate will be complete in all respects including the cost all respect including the cost of consumables, if any.



HYDERABAD

## STANDARD TECHNICAL SPECIFICATION FOR EARTHWORK IN EXCAVATION AND BACKFILLING

PEDC/STD.SPEC/03  
2 REV 00

Page 17 of 19

### 7.0.0 MEASUREMENTS

#### 7.1.0 CLEARING AND GRUBBING

No separate measurement shall be done for this item for the purpose of payment in General except for cutting of trees having girth more than 30cms and works Connected to this.

#### 7.2.0 EXCAVATION

Actual quantity of excavation required and approved by the Engineer shall be Measured in Cu.M.No extra shall be paid for keeping the excavations dewatered as Required for completion of the structure to come in. Necessary disposal of the spoil As described in the schedule of items shall be included in the quoted rate.

#### 7.3.0 SHORING

The actual efficient area of shoring as approved by the Engineer, shall be measured In Sq.m.All planks, walling, verticals, struts, props and all other materials as Required for the shoring and subsequent safe dismantling and removal shall be Included in the rates quoted.

#### 7.4.0 BACK-FILLING

##### 7.4.1 WITH ASSORTED EARTH FROM EXCAVATIONS, TRENCHES ETC

Actual quantity of consolidated backfill shall be measured in Cu.M. The cost of Lead, Lift, etc. shall be as per schedule of items and included in the rate quoted.

##### 7.4.2 WITH EARTH FROM BORROW PITS AND STACKS

Actual quantity of consolidated back-filling or actual quantity of excavation in the Borrow pits, or the excavated volume of the stack with a deduction of 30% for Voids, in case filling is done by earth from stack, whichever is less, shall be paid in Cu. M. The lead, lift, etc. as mentioned in the Schedule of item shall be included in The rates Quoted.

##### 7.4.3 SAND FILLING

Actual quantity of consolidated sand filling shall be measured in Cu. M. The rate shall include cost of sand and all necessary works for execution of the item.

#### 7.5.0 LEADS AND LIFTS

The leads for excavation and/or back filling will be measured between the centroid of the actual disposal area and that of the plan of pit. The distance between these Two points will two points will be measured along the shortest practicable haulage



HYDERABAD

# STANDARD TECHNICAL SPECIFICATION FOR EARTHWORK IN EXCAVATION AND BACKFILLING

PEDC/STD.SPEC/03  
2 REV 00

Page 18 of 19

Path as decided by the Engineer.

Lift will be measured vertically between the average ground level from where the Pit Excavation was started and the bottom level of the excavated pit. Level lines Corresponding to the stages where lifts become payable will be drawn on the cross Section of the pit and the volumes of excavation contained between these horizontal Planes will be computed and paid according to the corresponding rates.

## 7.6.0 DEWATERING

Dewatering for work beyond the contract period original or excavated will be Measured on the basis of horse power –hour which will be obtained by multiplying The estimated requirement of horse power required to run the pumps or actually Employed, whichever is less, by the actual hours run, approximated to the nearest Half hour.

## 7.7.0 TRANSPORTATION OF SURPLUS EARTH

7.7.1 Payment shall be made only for the lead beyond initial 100M from construction Area. Rate shall include reexcavation, loading, transportation, dumping, stacking or Spreading (as per directions of the engineer-in-charge) the surplus earth and the soil In the area demarcated by the Engineer-in – charge. Payment shall be made on Cubic Meter (M<sup>3</sup>) basis on the difference of measurements of the volumes of the Excavated Pits and the measurement of the back filling. Quantity generated due to Voids in back Filled volume of earth, shall also be removed by the Contractor at no Extra cost and This disposal of earth shall not measured and paid under any item.

7.7.2 In exceptional circumstances the Engineer- in-charge may direct the Contractor to Remove surplus earth, concrete or debris or any other material from site to the area Of disposal on the basis of truck measurement. In such cases volume of material Shall be calculated on the basis of truck volume reduce by 30% for voids in case of Soft/hard soil sand 50% for soft/hard rock. All other provisions of disposal such as Spreading, levelling, grading shall apply in this case also.

### ANNEXURE F3.1- VERY BROAD SPECIFICATIONS FOR SOIL TO BE CONSIDERED AS CNS MATERIAL

SL.NO.	PROPERTY	VERY BROAD SPECIFICATION RANGE
1.	Grain size analysis	
	(i) Clay	15-25%
	(ii) Silt	35%-50%



**STANDARD TECHNICAL SPECIFICATION  
FOR EARTHWORK IN EXCAVATION AND  
BACKFILLING**

PEDC/STD.SPEC/03  
2 REV 00

Page 19 of 19

HYDERABAD

	(iii) Sand	30-40%
	(iv) Gravel	< 10%
2.	Consistency limits	
	(i) Liquid limits	30-50%
	(ii) Plastic limit	20-25%
	(iii) Plasticity index	10-25%
	(iv) Shrinkage limit	15% and above
3. (a)	Swelling pressure when compacted to Maximum dry density corresponding to Standard proctor compaction with zero Initial compaction moisture constant, for No volume change condition.	Less than 0.1kg/cm <sup>2</sup> 10kN/m <sup>2</sup>
(b)	Swelling pressure when compacted to Maximum corresponding to standard Proctor compaction and initial compaction Moisture corresponding to optimum moisture Content for no volume change condition	less than 0.05kg/cm <sup>2</sup>
4.	Clay minerals	Preferable kaolinite Illite
5.	Shear strength of/ compacted to maximum dry Density correspond to standard proctor compaction And initial moisture content corresponding to Optimum moisture content, but sample test on Saturation.	
	(a) From unconfined compression	Cu0.15- 0.35 Kg/cmsq.
	(b) From consolidated undrained direct Shear test	Cu0.0.1-0.3 kg/cmsq. (10-30 kN/m sq)

**ADDENDUM TO SPECIFICATION NO. PEDC/STD.SPEC/032 REV 00  
FOR EARTHWORK**

Add under clause 3.70 back filling.

If it is required to use clayey soil exhibiting swelling properties for filling Around foundations and under pavement and floor slabs due to non Availability of suitable filling material nearby, then the back filled clayed Swelling soil should be well compacted and a layer of not less than 250mm Thick cohesive non-swelling (CNS) soil shall be placed on top of the clayey soil and well compacted. Very broad specifications for soil to be Considered as CNS material is given in Annexure F3:1 enclosed at the end of the section.



HYDERABAD

STANDARD TECHNICAL SPECIFICATION  
FOR CEMENT CONCRETE  
PLAIN AND REINFORCED

PEDC/STD.SPEC/004  
REV 00

Page 1 of 56

**CEMENT CONCRETE  
PLAIN AND REINFORCED**

REV. NO.	PRAPARED	APPROVED	DATE
00	MARINA	PMISHRA	00

**COPYRIGHT AND CONFIDENTIAL**

The information on this document is the property of BHARAT HEVY ELECTRICAL LTD.It must not be used directly or indirectly in any way detrimental to the interest of the Company.



STANDARD TECHNICAL SPECIFICATION  
FOR CEMENT CONCRETE  
PLAIN AND REINFORCED

PEDC/STD.SPEC/004  
REV 00

Page 2 of 56

HYDERABAD

TEBLE OF CONTENT

CLAUSE NO. DESCRIPTION

1.0	SCOPE.....
2.0	GENERAL.....
2.1	Work To Be Provided For By The Contractor.....
2.2	Work By Others.....
2.3	Information To Be Submitted By The Tenderer.....
2.3.1	With Tender.....
2.3.2	After Award.....
2.4	Conformity with Design.....
2.5	Materials To Be Used.....
2.5.1	General Requirement.....
2.5.2	Cement.....
2.5.3	Coarse Aggregate.....
2.5.4	Final Aggregate.....
2.5.5	Water.....
2.5.6	Admixture.....
2.5.7	Reinforcement.....
2.6	Storage of Materials.....
2.6.1	General.....
2.6.2	Cement.....
2.6.3	Aggregates.....



STANDARD TECHNICAL SPECIFICATION  
FOR CEMENT CONCRETE  
PLAIN AND REINFORCED

PEDC/STD.SPEC/004  
REV 00

Page 3 of 56

HYDERABAD

2.6.4	Reinforcement.....
2.7	Quality Control.....
3.0	INSTALLATION.....
	<b>CONTENT (CONT...)</b>
3.1	Washing And Screening Of Aggregates.....
3.2	Admixture.....
3.3	Grades of Concrete.....
3.4	Proportioning and Works Control.....
3.4.1	General.....
3.4.2	Mix Design Criteria.....
3.5	Strength Requirements.....
3.6	Minimum Cement Content.....
3.7	Water-Cement Ratio.....
3.7.1	Strength Requirement.....
3.7.2	Durability Requirement.....
3.8	Workability.....
3.9	Size of Coarse Aggregate.....
3.10	Mixing Of Concrete.....
3.11	Conveying Concrete.....
3.12	Placing And Compacting Concrete.....
3.13	Construction Joints and Cold Joints.....
3.13.1	Construction Joints.....
3.13.2	Cold Joints.....
3.14	Repairs, Finishes and Treatment Of Concrete Surfaces.....
3.14.1	Finishing Unformed Surface.....



HYDERABAD

STANDARD TECHNICAL SPECIFICATION  
FOR CEMENT CONCRETE  
PLAIN AND REINFORCED

PEDC/STD.SPEC/004  
REV 00

Page 4 of 56

3.15	Protection And Curing Of Concrete.....	
3.16	Reinforcement.....	
3.16.1	Bar Bending Schedule.....	
<b>CONTENT (Contd...)</b>		
3.16.2	Cleaning.....	
3.16.3	Bending.....	
3.16.4	Placing In Position.....	
3.16.5	Welding.....	
3.16.6	Control.....	
3.17	Cold Weather Concreting.....	
3.18	Hot Weather Concreting.....	
3.19	Concreting Under Water.....	
3.20	Formwork.....	
3.20.1	General.....	
3.20.2	Cleaning and Treatment of Forms.....	
3.20.3	Design.....	
3.20.4	Inspection .....	
3.20.5	Removal of Forms.....	
3.20.8	Classification.....	
3.21	Opening, Chases, Grooves, Recess, Blackouts Etc.....	
3.22	Anchor Bolts, Anchors, Sleeves, Inserts, Hangers /Conduits/Pipe and Other Misc. Embedded Fixtures.....	
3.23	Expansion And Isolation Joints.....	
3.23.1	General.....	



HYDERABAD

STANDARD TECHNICAL SPECIFICATION  
FOR CEMENT CONCRETE  
PLAIN AND REINFORCED

PEDC/STD.SPEC/004  
REV 00

Page 5 of 56

3.23.2 Bitumen Board /Expanded Polystyrene Boards.....

3.23.2.1 Bitumen Boards.....

3.23.2.2 Expanding Polystyrene Boards.....

3.23.3 Joint Sealing Strips.....

**CONTENT (Counted...)**

3.23.3.1 Metal Sealing Strips.....

3.23.3.2 Non- Metallic Sealing Strips.....

3.23.4 Joint Sealing Strips.....

3.23.5 Isolation Joints.....

3.23.6 Rubber Pad.....

3.24 Grouting Under Machinery Or  
Structural Steel Bases.....

3.25 Precast Concrete.....

3.26 Waterproofing Of Concrete Structure.....

3.26.1 General.....

3.26.2 Water Bar /Seal.....

3.26.3 Waterproofing Admixtures.....

3.26.4 Bituminous Or Tar Coating.....

3.26.5 Bitumen Felt Application For Tanking.....

3.26.6 Polyethylene Films: Application  
In Walls & Base of Structures.....

4.0 SAMPLING AND TESTING.....

3.21 General.....

3.22 Comment.....

3.23 Aggregates.....



HYDERABAD

STANDARD TECHNICAL SPECIFICATION  
FOR CEMENT CONCRETE  
PLAIN AND REINFORCED

PEDC/STD.SPEC/004  
REV 00

Page 6 of 56

3.24 Water.....

3.25 Admixture.....

3.25.1 Air Entraining Agent.....

3.25.2 Other Admixture.....

3.26 Concrete.....

**CONTENT (Counted...)**

5.0 ACCEPTANCE CRITERIA.....

5.2 Standard Deviation.....

5.2 Acceptance Criteria.....

5.3 Inspection and core Tests.....

5.4 Load Test.....

6.0 Rates.....

7.0 METHOD OF MEASUREMENT.....

7.1 Concrete.....

7.2 Admixture .....

7.3 Reinforcement.....

7.4 Formwork .....

7.5 Anchor Bolts, Anchor Sleeve, Inserts, Hangers, Conduit Pipes and Other  
Miscellaneous Embedded Fixtures.....

7.6 Expansion and Isolation Joints.....

7.7 Joins Seals: G.I. Copper, Aluminium, Rubber or P.V.C .....

7.8 Rubber Pad.....

7.9 Grouting Under Base Plates Etc.....

7.10 Waterproof Plaster.....



STANDARD TECHNICAL SPECIFICATION  
FOR CEMENT CONCRETE  
PLAIN AND REINFORCED

PEDC/STD.SPEC/004  
REV 00

Page 7 of 56

HYDERABAD

7.11 Bitumen Coating /Tar Coating.....

7.12 Bitumen Felt .....

7.13 Polyethylene Film .....

7.14 Tests .....

8.0 LIST OF I. S. CODES AND STANDARDS FOR

REFERENCE.....



HYDERABAD

STANDARD TECHNICAL SPECIFICATION  
FOR CEMENT CONCRETE  
PLAIN AND REINFORCED

PEDC/STD.SPEC/004  
REV 00

Page 8 of 56

## SCOPE

### 1.1 General

This specification covers all the requirements described hereinafter for general use of plain and reinforced cement concrete work in structures and locations, cast-in-situ or precast, and shall include all incidental items of work not shown or specified but reasonably implied or necessary for the completion of the work.

1.2 This specification shall also apply to the extent it has been referred to or applicable with the special requirements of structures covered in scope of IS: 456.

1.3 IS: 456 shall form a part of these specifications and shall be complied with unless permitted otherwise. For any particular aspect not covered by these code, appropriate IS code, specifications and/ or replacement by an international code of practices as may be specified by the engineer shall be followed. All code and standards shall conform to its latest revisions. A list of IS codes and standards is enclosed hereinafter for reference.

## 2.0 General

### 2.1 Work to be provided for by the contractor

The work to be provided for by the contractor, unless otherwise specified shall include but not be limited to the following:-

- a) Furnish all labour, supervision, services including facilities as may be required under statutory labour regulations, materials, forms, templates, supports, scaffolds, approaches, construction equipment, tools and plants, transportations- etc. required for the work.
- b) Except where it is excluded from the scope of contract, contractor shall prepare progressively and submit for approval detailed drawing and bar bending schedules for reinforcement bars showing the positions and details of spacers, supports, chairs, hangers etc.
- c) Design and prepare working drawing of formworks, scaffolds supports, etc. and submit for approval.



HYDERABAD

STANDARD TECHNICAL SPECIFICATION  
FOR CEMENT CONCRETE  
PLAIN AND REINFORCED

PEDC/STD.SPEC/004  
REV 00

Page 9 of 56

- d) Submit for approval shop drawing for various inserts, anchors, anchor, bolts, pipe sleeves, embodiments, hangers opening, frames etc.
- e) Submit for approval detailed drawing of supports, templates hangers etc. required for installation of various embedments like inserts, anchor bolts, pipe sleeves, frames, joint seals, frames, openings etc.
- f) Submit for approval detailed schemes of all operation required for executing the work, e. g. material handing, concrete mixing, placement of concrete, compaction, curing , services, approaches , etc.
- g) Design and submit for approval concrete mix designs required to be adopted on the job.
- h) Furnish samples and submit for approval results of tests of various properties of the following: -
  - i) The various ingredients of concrete
  - ii) Concrete
  - iii) Embedment
  - iv) Joint seals
- i) Provide all incidental items not shown or specified in particular but reasonably implied or necessary for successful completion of the work in accordance with the drawings, specifications and schedule of items.
- j) For supply of certain materials normally manufactured by specialist firms, the contractor may have to produce, if directed by the engineer, a guarantee in approved, perform for satisfactory performance for a reasonable period as may be specified , binding the manufactures and the contractor, jointly and severally.

**2.2 work by others**

No work under this specification will be provided by any agency other than the contractor unless specifically mentioned elsewhere in the contract.

**2.3 Information to be submitted by the tenderer**

**2.3.1 With tendered**

The following technical information are required with the tender.



HYDERABAD

STANDARD TECHNICAL SPECIFICATION  
FOR CEMENT CONCRETE  
PLAIN AND REINFORCED

PEDC/STD.SPEC/004  
REV 00

Page 10 of 56

- a) Source and arrangement of processing of aggregates proposed to be adopted.
- b) Type of plant and equipment proposed to be used.
- c) Names of firms with which association is sought for to execute the special items of work in the contract.
- d) Types of formwork proposed to be used.

**2.3.2 After award**

The contractor shall submit the following information and data including samples where necessary, progressively during the execution of the contract.

**a) Programme of execution and requirement of materials**

within 30 days of the award of contract, the contractor will submit a master programme for completion of the work giving month wise requirements of materials, particularly mentioning in details the materials which are to be supplied by the owner, and for the procurement of which the help of the owner is required as per the terms and conditions of the contract. in case the contractor proposes to take on hire any machineries or tools and plants from the owner, the detailed phased out programme of such hire is also to be submitted.

this master programme may have to be reviewed and updated by the contractor, quarterly or at more frequent intervals as may be directed by the engineer depending on the exigencies of the work.

detailed day-to-day programme of every month is to be submitted by the contractor before the end of the previous month.

**b) Samples**

Samples of the following materials and any other materials proposed to be used, shall be submitted as directed by the engineer, insufficient quantities free of cost, for approval. Approved samples will be preserved by the engineer for future reference. the approval of the engineer shall not, in any way, relieve the contractor of his responsibility of supplying materials of specified qualities:-

- i) Coarse and fine aggregates
- ii) admixtures
- iii) Plywood for form work.
- iv) Embedded and anchorage materials as may be desired by the engineer.
- v) Joint sealing strips and other water proofing materials.
- vi) Joints filling compounds
- vii) Foundations quality rubber pads

**c) Design mix**



HYDERABAD

STANDARD TECHNICAL SPECIFICATION  
FOR CEMENT CONCRETE  
PLAIN AND REINFORCED

PEDC/STD.SPEC/004  
REV 00

Page 11 of 56

Design mix as per clauses 2.1 (g) & 3.4 of this specification giving proportions of the ingredients. sources of aggregates and cement. along with accompanying test results of trial mixes as per relevant i. s. is to be submitted to the engineer for his approval before it can be used on the works.

**d) Detail drawing and bar bending schedules**

Detailed working drawings and bar bending schedules in accordance with clause 2.1 (b) and 3.16.1 of this specification.

**e) Detailed drawing and designs of formworks to be used**

Detailed design data and drawings of standard formworks to be used as per clauses 2.1 (c).

**Detailed drawing for templates & temporary supports for embodiments**

As per clause 2.1(e).

**g) Mill test report for cement & reinforcing steel**

mill test report for cement and reinforcing steel in case these Materials are supplied by the contractor.

**H) Inspection reports**

Inspection reports in respect of form work and reinforcement and any other item of work as may be desired by engineer in accordance with clause 2.4 of this specification.

**i) test reports**

Reports of tests of various materials and concrete as required under clause 4.0: sampling & testing of this specification.

j) any other data which may be required as this per this specification

**2.4 Conformity With Design**

The contractor will prepare check in approved Performa, which will be called pour cards. These pour cards will list out all items of work involved the contractor will inform the engineer, sufficiently in advance, whenever any particular pour is ready for concreting he shall accord all necessary help and assistance to the engineer for all checking required in the pour. On specification, the engineer will give written permission on the same poured card allowing the contractor to commence placement of concrete. Details of all instruction issued by the engineer and any other relevant information will be written on accompany sheets,



HYDERABAD

STANDARD TECHNICAL SPECIFICATION  
FOR CEMENT CONCRETE  
PLAIN AND REINFORCED

PEDC/STD.SPEC/004  
REV 00

Page 12 of 56

termed as progress cards, will be prepared by the contractor on approved Performa. The pour cards along with accompaniments will be handed over to the engineer before starting placement of concrete. One of the mix designs developed by the contractor as per the I. S. specifications and established the satisfaction of the engineer by trial mixes shall be permitted to be used by the engineer, the choice being dictated by the requirements of designs and workability. The methods of mixing, of concrete will be as approved or directed by the engineer.

## 2.5 Materials to be used

### 2.6 General Requirement

2.7 All materials whether to be incorporated work or used temporarily for the construction shall conform to the relevant IS specifications unless stated otherwise and be of best-approved quality.

#### 2.5.2 Cement

Generally, cement shall be ordinary Portland cement conforming to IS :8112. In special case, rapid hardening Portland cement, low heat cement etc. May be permitted or directed to be used by the engineer.

#### 2.5.3 Coarse Aggregate

Aggregate of size ranging between 4.75 mm and 150mm will be termed as coarse aggregate. only coarse aggregate from approved quarries and conforming to is: 383 will be allowed to be used on the works.

#### 2.5.4 Fine Aggregate

Aggregate smaller than 4.75 mm and within the grading limits and other requirement set in is:383 is termed as fine aggregate or sand. only fine aggregate from approved sources and conforming to the above is specification will be allowed to be used on works.

#### 2.5.5 Water

Water for use in concrete shall be clear and free from injurious oils, acids, alkalis, organic matter, salt, silts or other impurities. Normally potable water is found to be suitable. generally, is:3550 will be followed for routine tests. in



HYDERABAD

STANDARD TECHNICAL SPECIFICATION  
FOR CEMENT CONCRETE  
PLAIN AND REINFORCED

PEDC/STD.SPEC/004  
REV 00

Page 13 of 56

case of doubt, the acceptance test for water shall be as per is: 3025, and table-i of is: 456.

**2.5.6 Admixture**

Only admixture of a quality will be used when directed or permitted by the engineer. the admixture shell conform to is: 9103.

**2.5.7 Reinforcement**

Reinforcement shell be as per relevant is specification as mentioned in the contract/drawing/instruction. all bars above 10mm dia. shall be tested quality.

**2.6.0 Storage of materials**

**2.6.1 General**

All materials shall be so as to prevent deterioration or intrusion of Foreign matter and to ensure the preservation of their quality and fitness for the work. Any material, which has deteriorated or has been damaged or is otherwise considered defective by the engineer, shell not be used for concrete and shell be removed from site immediately, failing which, the engineer shall be at liberty to get the materials removed from site immediately, failing which, the engineer shall be at

Liberty to get the materials removed and the cost incurred there of shall be realised from the contractors dues. The contractor shall maintain up to- date

**2.6.2 Cement:**

- 1) Sufficient space for storage, with open passages between stacks, shall arranged by the contractor to the satisfaction of the engineer.
- 2) Cement shall be stored off the ground in dry, leak proof, well-ventilated ware-houses at the works in such in such a manner as to prevent deterioration due to the moisture or intrusion of foreign matter. Cement shall be stored in easily countable stacks with consignment identification marks.
- 3) Consignment shall be used in the order of their receipts at site. Sub – standards or partly set cement shall be removed from the site, with the knowledge of the engineer, as soon as it is detected

**2.6.3 Aggregate:**

Aggregate shall be stored on planks or steel plates or on concrete or masonry surface. Each size shall be kept separated with wooden or steel or concrete or masonry bulk-heads or in separate stacks and sufficient care shall be taken to prevent the material at the edges of the stock piles from getting intermixed. Stacks of fine and coarse aggregates shall be kept sufficiently apart with proper arrangement of drainage. The aggregates shall be stored in easily measurable stacks of suitable depths as may be directed by the engineer.



HYDERABAD

STANDARD TECHNICAL SPECIFICATION  
FOR CEMENT CONCRETE  
PLAIN AND REINFORCED

PEDC/STD.SPEC/004  
REV 00

Page 14 of 56

**2.6.4 Reinforcement:**

Reinforcement steel shall be stored consignment-wise and size wise off the ground and under cover, if desired by the engineer, it shall be protected from rusting, oil, grease and distortions. If necessary, the reinforcing steel may be coated with cement wash before stacking to prevent scale and rust at no extra cost to the owner. The stacks shall be easily measurable. Steel needed for immediate use shall be removed from storage.

**2.7 Quality Control:**

Contractor shall be establish and maintain quality control for different items of work and materials as may be directly by the engineer to assure compliance with contract requirement and maintain and submit to the engineer records of the same. The quality control operation shall include.

- a) Admixture : Type, quantity, physical and properties that affect Strength, workability and durability of concrete.  
For air entraining admixtures, dosage to be adjusted to Maintain air contents within desirable limits.
- b) Aggregate : physical, chemical and mineralogical qualities. Grading, Moisture content and impurities.
- c) Water : Impurities tests.
- d) Cement : Test of satisfy relevant IS specification (only association With Owner s tests, if the supply is made by Owner).
- e) formwork : material , shapes dimensions, lines elevation , surface Finish, adequacy of form , ties, bracing and shoring and Coating.
- f) Reinforcement : shapes, dimensions, length of splices, clearances, items and supports . Quality and requirement of welded splices.
- g) Grades of concrete : Usage and mix design, testing of all properties.
- h) Batching & mixing : Types and capacity of plant, concrete mixers and transportation equipment.



HYDERABAD

STANDARD TECHNICAL SPECIFICATION  
FOR CEMENT CONCRETE  
PLAIN AND REINFORCED

PEDC/STD.SPEC/004  
REV 00

Page 15 of 56

- i) joints : Location of joints, water stops and filler materials.  
Dimension of joints, quality and shape of joint material and Splices.
- j) Embedded and Anchorage items : Material, shape, location, setting.
- k) Placing : preparation, rate of pouring weather limitations, time intervals between mixing and placing and between two successive lifts, covering over dry or wet surfaces, cleaning and proper bond, prevention of cold joint, types of chutes or conveyors.
- l) Compaction : numbers of vibration, their prime mover, frequency and amplitude of vibration, diameter and weight of vibrators, duration of Vibration, hand – spreading, rodding and tamping.
- m) Setting of base & Beaming plates : Lines, elevations and bedding mortar.
- n) Concrete finishes : Repairs of surface defects, screening, floating, steel troweling and Booming, special finishes.
- o) Curing : Methods and length of time.

Copies or records and tests for the items noted above, as well as, records of corrective Action taken shall be submitted to the engineer for approval as may be desired.

### 3.0 INSTALLATION

All installation requirements shall be in accordance with IS: 456 and as supplemented or modified herein or by other best possible standards where the specific requirement Mentioned in this section of the specification do not cover all the aspects to the full Satisfaction of the Engineer.

#### 3.1 Washing and screening of Aggregates

Washing and screening of coarse and fine aggregates to remove fines, dirt or other deleterious materials shall be carried out by approved means as desired by the Engineer.

#### 3.2 Admixture



STANDARD TECHNICAL SPECIFICATION  
FOR CEMENT CONCRETE  
PLAIN AND REINFORCED

PEDC/STD.SPEC/004  
REV 00

Page 16 of 56

HYDERABAD

All concrete shall be designed for normal rate of setting and hardening at normal temperature. Variations in temperature and humidity under different climatic conditions will affect the rate of setting and hardening, which will, in turn, affect the workability and quality of the concrete. Admixtures may be permitted to be used in accordance with IS: 456 to modify the rate of hardening, to improve workability or as an aid to control concrete quality. The Engineer reserves the right to require laboratory test or use test data, or other satisfactory reference before granting approval. The admixture shall be used strictly in accordance with the manufacturer's directions and /or as directed by the Engineer.

### 3.3 Grades of Concrete

Concrete shall be in any of the grades designated in IS: 456. Grade of concrete to be used in different parts of work shall be as shown on the drawing or as per the Engineer's instruction. In case of liquid retaining structures, IS: 3370 will be followed.

### 3.4 Proportioning and Works Control

#### 3.4.1 General

Proportioning of ingredients of concrete shall be made by any of the two following Methods as directed by the Engineer.

- a) With preliminary tests by designing the concrete mix. Such concrete shall be called "Design Mix Concrete"
- b) Without preliminary tests adopting nominal concrete mix. Such concrete shall be called "Nominal mix Concrete."

As far as possible, design mix concrete shall be used on all concrete works. Ordinary concrete, in grades permitted in accordance with IS: 456 may be used if shown on drawing or approved by the Engineer. In all cases the proportioning of ingredient and works control shall be in accordance with IS: 456 and shall be adopted for use after the Engineer is satisfied regarding its adequacy and after obtaining his approval in writing.

#### 3.4.2 Mix Design Criteria

Concrete mixing will be designed by the Contractor to achieve the strength, durability and workability necessary for the job, by the most economical use of the various ingredients. In general, the design will keep in view the following considerations: -

- a) Consistent with various other requirements of the mix, the quantity of water should be kept at the lowest possible level.
- b) The nominal maximum size of coarse aggregate shall be as large as possible within the limits specified.



HYDERABAD

STANDARD TECHNICAL SPECIFICATION  
FOR CEMENT CONCRETE  
PLAIN AND REINFORCED

PEDC/STD.SPEC/004  
REV 00

Page 17 of 56

- c) The various fractions of coarse and fine aggregates should be mixed in such a proportion as to produce the best possible combined internal grading giving the densest and most workable mix.
- d) The finished concrete should have adequate durability in all conditions to withstand satisfactorily the weather and other destruction agencies which it is expected to be subjected to in actual services.

The requirement of adequate structural strength is catered for by the choice of proper grade of concrete by the Engineer. The Contractor will strictly abide by the same in his design of concrete mix installation.

Notwithstanding anything mentioned in various tables given in IS:456 giving specific values and degrees of workability for different condition of concrete placing, minimum cement content and maximum water cement ratio for concrete exposed to sulphate attack and for concrete to ensure durability under different condition of exposure, strength requirement for different grades of concrete, proportion for nominal mix concrete, the following tables in the specification are included. For identical condition is values given in the tables shown herein below are different from those mentioned in IS:456, the values as indicated in the table shown herein below shall prevail.

TABLE – 1

STRENGTH REQUIREMENT OF CONCRETE

---

Grade of Concrete	Specific Characteristic Compressive Strength of 15cm cubes at 28 days conducted in accordance with IS: 516(All values in N/Sq.mm)
M – 10	10
M – 15	15
M – 20	20
M – 25	25
M – 30	30
M – 35	35
M – 40	40

---



**STANDARD TECHNICAL SPECIFICATION  
FOR CEMENT CONCRETE  
PLAIN AND REINFORCED**

PEDC/STD.SPEC/004  
REV 00

Page 18 of 56

HYDERABAD

Note: 1. Notwithstanding anything mentioned above, the cement/total aggregate ratio is not to be increased beyond 1:9.0 without specific permission of the Engineer

Note: 2. It should be noted that such high aggregate cement ratio will be required for concretes of very low slump and high water – cement ratio which may be required to be used in mass concrete work only .

Note: 3. The above figures are guidance only , the actual cement /aggregate ratios are to be worked out from the specific gravities of coarse aggregates and sand being used and from trial mixes.

### 3.5 Strength Requirements

Strength Requirements of both design mix and nominal mix concrete where ordinary Portland Cement or Portland Blast furnace slag cement is used, shall be as per IS: 456. All other relevant clauses of IS: 456 shall also apply.

### 3.6 Minimum Cement Content

The minimum cement content for each grade of concrete shall be as shown below unless specified in schedule of items: -

**TABLE –III**

**Minimum Cement CONTENT, Maximum Water Cement Ratio and Minimum Grade of Concrete for Different Exposures with Normal Weight Aggregates of 20 mm nominal maximum Size**

SI No.	Exposure	Plain Concrete			Reinforced Concrete		
		Minimum Cement Concrete Kg/m <sup>3</sup>	Maximum Free Water Cement Ratio	Minimum Grade of Concrete	Minimum Cement Concrete Kg/m <sup>3</sup>	Maximum Free Water Cement Ratio	Minimum Grade of Concrete
1	2	3	4	5	6	7	8
i)	Mild	220	0.60		300	0.55	M20
ii)	Moderate	240	0.60	M15	300	0.50	M25
iii)	Severe	250	0.50	M20	320	0.45	M30
iv)	Very severe	260	0.45	M20	340	0.45	M35
v)	Extreme	280	0.40	M25	360	0.40	M40



STANDARD TECHNICAL SPECIFICATION  
FOR CEMENT CONCRETE  
PLAIN AND REINFORCED

PEDC/STD.SPEC/004  
REV 00

Page 19 of 56

HYDERABAD

Note: 1. Cement content prescribed in this table is irrespective of the grades of cement and it is inclusive of additions mentioned in 5.2. The additions such as fly ash or ground granulated blast furnace slag may be taken into account in the concrete composition with respect to the cement content and water – cement ratio if the suitability is established and as long as the maximum amounts taken into account do not exceed the limit of pozzolona and slag specified in IS 1489 (part I) and IS 455 respectively.

2. Minimum grade of plain concrete under mild exposure condition is not specified.

**TABLE - II**

**MIX PROPORTIONS (BY WEIGHT) EXPECTED TO GIVE DIFFERENT DEGREES OF  
WORKABILITY WITH DIFFERENT VALUES OF WATER – CEMENT RATIO**

(FOR GUIDANCE)

CEMENT/TOTAL AGGREGATE RATIOS

WORKABILITY	WATER/ CEMENT RATIO	RATIO BY WEIGHT OF CEMENT TO GRAVEL AGGREGATE		RATIO WEIGHT OF CEMENT TO CRUSHED STONE AGGREGTE	
		20mm size	30mm size	20mm size	38mm size
Very low slump 0-25 mm	0.4	1:4.8	1: 5.3	1: 4.5	1: 5.0
	0.5	1:7.2	1: 7.7	1: 6.5	1: 7.4
	0.6	1:9.4	1: 10	1: 7.8	1: 9.6
	0.7	1:10	1: 12	1: 8.7	1: 10.6
Low slump 25-50 mm	0.4	1:3.9	1: 4.5	1: 3.5	1: 4.0
	0.5	1:5.5	1: 6.7	1: 5.0	1: 5.5
	0.6	1:6.8	1: 7.4	1: 6.3	1: 7.0
	0.7	1:8.0	1: 8.5	1: 7.4	1: 8.0
Medium slump 50-100 mm	0.4	1:3.5	1: 3.8	1: 3.1	1: 3.6
	0.5	1:4.8	1: 5.7	1: 4.2	1: 5.0
	0.6	1:6.0	1:7.3	1: 5.2	1: 6.2



STANDARD TECHNICAL SPECIFICATION  
FOR CEMENT CONCRETE  
PLAIN AND REINFORCED

PEDC/STD.SPEC/004  
REV 00

Page 20 of 56

HYDERABAD

High slump 100-175 mm	0.4 0.5 0.6 0.7	1:3.2 1:4.4 1:5.4 1:6.2	1: 3.5 1: 5.2 1: 6.7 1: 7.4	1: 2.9 1: 3.9 1: 4.7 1: 5.5	1: 3.3 1: 4.6 1: 5.7 1: 6.5
--------------------------	--------------------------	----------------------------------	--------------------------------------	--------------------------------------	--------------------------------------

Note: 1- notwithstanding anything mentioned above, the cement/ Total aggregate ratio is not be increased beyond 1; 9.0 without specific permission of the Engineer

Favourable conditions, on of better quality of cement control, then the Engineer may instruct lower cement content, and Contractor shall abide by the stipulations laid down hereunder:

- The contractor shall design the mixes for 10% (ten percent) higher strength over and above those specified in table-I under Clause 3.4, for the various grades of concrete and different slump requirement.
- Sufficient number of trial mixes (to be decided by the Engineer) will be taken at the laboratory for the various designs and graphs of w/c ratio Vs crushing strengths at various ages will be plotted.
- All tests will be done in presence of the Engineer who shall be the final authority to decide upon the adoption of any revised minimum cement content. The contractor will always be responsible to produce quality concrete of the required grade as per the acceptance criteria of IS 456.
- The Engineer will always have the unquestionable right to revise the minimum cement content as decided above, if in his opinion, there is any chance of deterioration of quality on account of use of lower cement content or any other reason.

In case there is a downward revision of the minimum cement content from that specified in the contract, the particular unit rate of concrete will be reduced by an amount equal to the cost of cement saved, calculated at the issue rate. The relevant cost of wastage and handling on the cement saved, which is inherent in the total cost of structure, will not be deducted from the unit rate and will thus pass on the Contractor.

### 3.7 Water Cement Ratio

The choice of water-cement ratio in designing a concrete mix will depend on

- The requirement of strength
- The requirement of durability.

#### 3.7.1 Strength Requirement



HYDERABAD

**STANDARD TECHNICAL SPECIFICATION  
FOR CEMENT CONCRETE  
PLAIN AND REINFORCED**

PEDC/STD.SPEC/004  
REV 00

Page 21 of 56

In case of “Design Mix Concrete”, the water-cement ratio of such value as to Give acceptable test results as per IS: 4 56, will be selected by trial and error. The values of water – cement ratio for different grade and mix designs will have to be established after conducting sufficiently large number of preliminary test laboratory to the satisfaction of Engineer. Frequent checks on test will have to be carried out and the water – cement ratio will be revised if the tests produce unsatisfactory results. Notwithstanding anything stated above all the consequences in case of default remains unaltered.

In case of ordinary concrete, the maximum water – cement ratio for different grades of concrete is specified in table –III of IS: 456 and no tests are necessary. The acceptance test criterion for nominal mix concrete shall be as per IS: 456.

**3.7.2 Durability Requirement**

Tables 19 & 20 of IS: 456 give the maximum water – cement ratio permissible from the point of view of durability of concrete subjected to adverse exposure to weather, sulphate attacks, and contact with harmful chemical. Impermeability may also be an important consideration.

Whenever the water – cement ratio dictated by Durability consideration is lower then that required from strength criterion, the form shall be adopted.

However, water – cement ratio, from the point of durability as well as from strength consideration, should meet the requirement given in Table No.IV.

**TABLE IV**

**MAXMIUM PERMISSIBLE WATER / CEMENT RATIOS FROM  
DURABILITYCONSIDERATIONS FOR DIFFEREN TYPES OF STRUCTURES AND  
DEGREES OF EXPOSURE USING ORDINARY PORT LAND CEMENT**

	Exposure Conditions					
	Severe wide range of Temperature. Frequent alterations of freezing and thawing (use Air Entrained concrete only)			Mild Temperature rarely below Freezing or rainy or arid		
Type of structure	At the water line or within the range of fluctuating water level or spray.			At the water line or within the range of fluctuating water level or spray.		
	In air			In air		



**STANDARD TECHNICAL SPECIFICATION  
FOR CEMENT CONCRETE  
PLAIN AND REINFORCED**

PEDC/STD.SPEC/004  
REV 00

Page 22 of 56

HYDERABAD

	In Fresh water	In sea water or in contact with sulphate (concentration more than 0. 2p.c)		In fresh water	In sea water or in contact with sulphate (concentration more than 0. 2p.c)
--	----------------	--	--	----------------	--

Thin sections such as railing kerbs, sills ledges, ornamental or Architectural concrete reinforced concrete piles, pipes and all sections with less than 1” concrete cover to reinforcement	0.49	0.44	0.40	0.53	0.49	0.40
Moderate sections such as Retaining Walls, abutments, piers, girders, beams	0.53	0.49	0.40	*	0.53	0.44
Exterior portions of heavy mass sections	0.58	0.49	0.44	*	0.53	0.44
Concrete deposited by Tremie under water	-	0.44	0.44	-	0.44	0.44
Concrete slabs laid on ground	0.53	-	-	*	-	-
Concrete which will later be protected by enclosure or backfill but which may be exposed to freezing & thawing for several years before such protection is offered	0.53	-	-	*	-	-



**STANDARD TECHNICAL SPECIFICATION  
FOR CEMENT CONCRETE  
PLAIN AND REINFORCED**

PEDC/STD.SPEC/004  
REV 00

Page 23 of 56

HYDERABAD

Concrete protected from the water, interiors of building concrete below ground which is free from sulphate attacks	*	-	-	*	-	-
--	---	---	---	---	---	---

Note: \* Water/Cement ratios be selected on basis of strength and workability requirements.

### 3.8 Workability

The degree of workability necessary to allow the concrete to be well consolidated and to be worked into the corners of formwork and around the reinforcement and embodiments and to give the required surface finish shall depend on the type and nature of structure and shall be based on experience and tests. The usual limits of consistency for various types of structures are given below: -

**TABLE - V  
LIMITS OF CONSISTENCY**

Degree of Workability	Slump in mm with standard Cone as per IS: 1199		Use for which concrete is suitable
	Min	Max	
Very low	0	25	Large mass concrete structure with heavy compaction equipments, roads and like
Low	25	50	Uncontested wide and shallow R.C.C. Structures
Medium	50	100	Deep but wide R.C.C. Structures with congestion or reinforcement and inserts
High	100	150	Very narrow and deep R.C.C. structures with congestion due to reinforcement and inserts.

(Note: Notwithstanding anything mentioned above, the slump to be obtained for work in professes shall be as per direction of the engineer)



HYDERABAD

STANDARD TECHNICAL SPECIFICATION  
FOR CEMENT CONCRETE  
PLAIN AND REINFORCED

PEDC/STD.SPEC/004  
REV 00

Page 24 of 56

With the permission of the engineer, for any grade of concrete, if the water has to be increased in special cases, cement shall also be increased proportionately to keep the ratio of water to cement same as adopted in trial mix design for each grade of concrete. No extra payment will be made for this additional cement.

Workability of concrete shall be checked at frequent intervals by slump tests. Alternative where facilities exist or if required by the engineer, the compacting factor test in accordance with IS: 1199 and Clause 6 of IS: 456 shall be carried out.

### 3.9 Size of Coarse Aggregates

The maximum size of coarse aggregates for different locations shall be as follows unless otherwise directed by the Engineer: -

Very narrow space	-	12mm
Reinforced concrete except foundation	-	20mm
Ordinary plain concrete and Reinforced	-	40mm
Mass concrete	-	80mm
Mass concrete very large structure	-	150mm

Grading of coarse aggregates for a particular size shall conform to relevant I.S. Codes and shall also be such as to produce a dense of the specified proportion, strength and consistency that will work readily into position without segregation.

Course aggregate will normally be separated into the following size and stacked separately in properly designed stockpiles ; 150mm to 80mm, 80mm to 40mm, 40mm to 20mm and 20mm to 5mm. In certain it may be necessary to further split the 20mm to 5mm fraction into 20mm to 10mm and 10mm to 5mm fractions.

This separation of aggregates in different size fraction is necessary so that they may be remixed in the desired proportion to arrive at a correct internal grading to produce the best mix.

### 3.10 Mixing of Concrete

Concrete shall always be mixed in mechanical mixer unless specifically approved by the Engineer for concrete to be used in unimportant out of the way locations in small quantities. Water shall not normally be charged into the drum of the mixer until all the cement and aggregates consisting the batch are already in the drum and mixed for at least one minute. Mixing of each batch shall be continued until there is a uniform distribution of the materials and the mass is uniform in color and consistency, but in no case shall mixing be done for less than 2



HYDERABAD

STANDARD TECHNICAL SPECIFICATION  
FOR CEMENT CONCRETE  
PLAIN AND REINFORCED

PEDC/STD.SPEC/004  
REV 00

Page 25 of 56

(two) minutes and at least 40 (forty) revolutions after all the material and water are in the drum. When absorbent aggregates are used or when the mix is very dry, the mixing time shall be extended as may be directed by the Engineer. Mixers shall not be loaded above their rated capacity as this prevents thorough mixing.

The entire contents of the drum shall be discharged before the ingredients for the next batch are fed into the drum. No partly set or remixed or excessively wet concrete shall be used. Such concrete shall be immediately removed from site. Each time the work stops, the mixers, shall be thoroughly cleaned & when the next mixing commences, the first batch shall have 10% additional cement at no extra cost to the Owner to allow for loss in the drum.

Regular checks on mixer efficiency shall be carried out as directed by the engineer as per IS: 4634 on all mixers employed at site. Only those mixers whose efficiencies are within the tolerances specified in IS: 1791 will be allowed to be employed.

Batching plant where used shall conform to IS: 4925.

When hand mixing is permitted by engineer, it shall be carried out on a water – tight platform and care shall be taken to ensure that mixing is continued until the mass is uniform in colour and consistency. In case of hand –mixing, 10% extra cement shall be added to each batch at no extra cost to the Owner.

3.11

**Conveying concrete**

Concrete shall be handled and conveyed from the place of mixing to the place of laying as rapidly as practicable by approved means and placed and compacted in the final position –before the Initial settings of the cement starts. Concrete should be conveyed in such a way as will prevent segregation or loss of any of the ingredients. For long distance haulage, agitator cars of approved design will be used. If in spite of all precautions, segregation does occur during transport, the concrete shall be properly remixed before placement. During hot or cold weather, if directed by the Engineer, concrete shall be transported in deep containers which will reduce the rate of loss of water evaporation or loss of heat. If equipments for concrete shall be well maintained and thoroughly cleaned before commencement of concrete mixing. Such equipments shall be kept free from set concrete.

A layer of mortar of thickness 12mm of the same or less w/c ratio and the same proportion as that of the concrete being placed and cement slurry will be spread thoroughly on the rock foundation or construction joint just prior to placement of concrete. The cost of application of such cement slurry and mortar will be deemed to be included in the unit rate of concrete.

After concrete has been placed, it shall be spread, if necessary and thoroughly compacted by approved mechanical vibration to maximum subsidence without segregation and thoroughly worked around shape. Vibrators shall not be used for pushing concrete into adjoining areas. Vibrators must be operated by experienced



HYDERABAD

STANDARD TECHNICAL SPECIFICATION  
FOR CEMENT CONCRETE  
PLAIN AND REINFORCED

PEDC/STD.SPEC/004  
REV 00

Page 26 of 56

workmen and the work carried out as per relevant IS Code of Practice. In thin members with heavy congestion of reinforcement or other embedments, where effective use of internal vibrator is, in the opinion of the Engineer, doubtful, in addition to immersion vibration the contractor may have to employ form vibrators conforming to IS: 4656. For slabs and other similar structures, the contractor will additionally employ screed vibrator as per IS:2506. Hand tamping may be allowed in rare cases, subject to the approval of the Engineer. Care must be taken to ensure that the inserts, fixtures, reinforcement and formwork are not displaced or distorted during placing and consolidation of concrete.

The rate of placement of concrete shall be such that no cold joint is formed and fresh concrete is placed always against green concrete which is still plastic and workable. No concrete shall be placed in open, during rains. During rainy season, no placement in the open is to be attempted unless sufficient tarpaulins or other similar protective arrangement for completely covering the still green concrete from rain is kept at the site of placement. If there has been any sign of washing of cement and sand, the entire affected concrete shall be removed immediately. Suitable precautions shall be taken in advance to guard against rains before leaving the fresh concrete unattended. No accumulation of water shall be permitted on or around freshly laid concrete.,

Slabs, beams and similar members shall be poured in one operation, unless otherwise instructed by the Engineer. Moulding, throating, drip course, etc. shall be poured as shown on the drawings or as directed by the Engineer. Holes shall be provided and bolts, sleeves, anchor's fastenings or other fixtures shall be embedded in concrete as shown on the drawings or as directed by the engineer. Any deviation there from shall be set right by the Contractor at his own expense as instructed by the Engineer.

In case the forms or supports get displaced during or immediately after the placement and bring the concrete surface out of alignment beyond tolerance limits, the Engineer may direct to remove the portion and reconstruct or repair the same at the Contractor's expense.

### 3.12 **Placing and Compacting Concrete**

Where specifically covered the relevant IS Code will be followed for the procedure of surface preparation, placement, consolidation, curing, finishes, repairs and maintenance of concrete. If, however, there is no specific provision in the relevant IS Code for any particular aspect or work, any other standard Code of Practice, as may be specified by the Engineer, will be adopted. Concrete may have to be placed against the following types of surfaces:-

- a) Earth foundations
- b) Rock foundations
- c) Formwork



HYDERABAD

STANDARD TECHNICAL SPECIFICATION  
FOR CEMENT CONCRETE  
PLAIN AND REINFORCED

PEDC/STD.SPEC/004  
REV 00

Page 27 of 56

d) Construction joint in concrete or masonry.

The surface on or against which concrete is to be placed has to be cleaned thoroughly. Rock or old construction joint has to be roughened by wire brushing, chipping sand blasting or any other approved means for proper bond. All cutting's dirt, oil, foreign and deleterious material, laitance, etc., are to be removed by the air water jetting or water at high pressure. Earth foundation on which direct placement of concrete is allowed, will be crumble and consolidated as directed by the Engineer such that it does not crumble and get mixed up with the concrete during or after placement, before it has sufficiently set and hardened.

Formwork, reinforcement, preparation of surface, embodiments, joint seals etc., shall be approved in writing by the Engineer before concrete is placed. As far as possible, concrete shall be placed in the formwork by means approved by the Engineer and shall not be dropped from a height or handled in manner which may cause segregation. Any drop over 1500 mm shall have to be approved by the Engineer.

Rock foundation or construction joint will be kept moist for at least 72 hours prior to placement. Concrete will be placed always against moist surface but never on pools of water. In case the foundation cannot be dewatered completely, special procedure and precaution, as directed by the engineer will have to be adopted.

Formwork will be cleaned thoroughly and smeared lightly with form oil or grease of approved quality just prior to placement.

The Engineer shall decide upon the time interval between two placements of concrete of different ages coming in contact with each other, taking in consideration the degree of maturity of the older concrete, shrinkage, heat dissipation and the ability of the older concrete to withstand the load imposed upon it by the fresh placement.

Once the concrete is deposited, consolidated and finished in its final position., it shall not be distributed.

3.13 **Construction Joints and Cold Joint**

3.13.1 **Construction Joints**

It is always desirable to complete any concrete structure by continuous pouring in one operation. However, due to practical limitation of methods and equipment and certain design considerations, construction joints are formed by discontinuing concrete at certain predetermined stages. These joints will be formed in a manner specified in the drawings/Instruction. Vertical construction joints will be made with rigid stop-board forms having slots for allowing passage of reinforcement rods and any other embodiments and fixtures that may be shown. For water retaining structures and leak proof buildings suitable and approved water stops may be installed at the construction joints as per clause 12.4 of IS: 456.



HYDERABAD

STANDARD TECHNICAL SPECIFICATION  
FOR CEMENT CONCRETE  
PLAIN AND REINFORCED

PEDC/STD.SPEC/004  
REV 00

Page 28 of 56

Where the location of the joints are not specified, it will be in accordance with the following: -

- a) In a column, the joint shall be formed 75 mm below the lowest soft of the beam framing into it.
- b) Concrete in a beam shall preferably be placed without a joint, but if provision of a joint is unavoidable, the joint shall be vertical and in the middle of the span.
- c) A joint in a suspended floor slab shall be vertical and at the middle of the span and at right angles to the principal reinforcement.
- d) Feather-edges in concrete shall be avoided while forming a joint.
- e) A construction joint should preferably be placed in a low-stress zone and at right angles to the direction of the principal stress.
- f) In case the Contractor proposes to have a construction joint anywhere to facilitate his work, the proposal should be submitted well in advance to the Engineer for study and approval with which no construction joint will be allowed.

**3.13.2 Cold joint**

An advancing face or a concrete pour, which could not be covered by fresh concrete before expiry of initial setting time (due to an unscheduled stoppage or delay on account of breakdown in plant, inclement weather, low rate of placement or any other reason), is called a cold joint. The Contractor should always remain vigilant to avoid cold joints.

If, however, a cold joint is formed due to unavoidable reasons, the following procedure shall be adopted for treating it:-

- a) If the concrete is so green that it can be removed manually and if vibrators can penetrate the surface without much effort, fresh concrete can be placed directly against the old surface. The old concrete should be covered by fresh concrete as quickly as possible and the joint thoroughly and systematically vibrated.
- b) In case concrete has hardened a bit more than (a) but can still be easily removed by a light hand pick, the surface will be raked thoroughly and the loose concrete removed completely without disturbing the rest of the concrete in depth. A rich mortar layer 12 mm in thickness, will be placed on the cold joint. Fresh concrete shall be placed on the mortar layer and the joint will be thoroughly and systematically vibrated penetrating the vibrator deep into the old layer of concrete.
- c) In case the concrete at the joint has become so stiff that it cannot be remoulded and mortar or slurry does not rise in spite of extensive vibration,



STANDARD TECHNICAL SPECIFICATION  
FOR CEMENT CONCRETE  
PLAIN AND REINFORCED

PEDC/STD.SPEC/004  
REV 00

Page 29 of 56

HYDERABAD

the joint will be left to harden for at least 12 – 24 hrs. It will then be treated as a regular construction joint, after cutting the concrete to required shape and preparing the surface as described under clause 3.12.

### 3.14 Repairs, Finishes and Treatment of Concrete surfaces

3.14.1 Adequate and sound concrete surfaces, whether formed or unformed, can be obtained by employing a concrete mix of proper design, competent formwork, appropriate methods of handling, placing and consolidation by experienced workmen.

Unsound concrete resulting from improper mix design, incompetent methods, equipment and formwork poor workmanship and protection will not be accepted and will have to be dismantled, removed and replaced by sound concrete at the Contractor's cost. The Engineer may, at his sole discretion, allow to retain concrete with minor defects provided the Contractor is able to repair it by approved methods at no extra cost to the Owner. All concrete work shall be inspected by the Contractor immediately after the forms are removed and he will promptly report occurrence of any defects to the Engineer. All repair works will be carried out as per the instructions and in the presence of the Engineer or his representative. Generally, repair work will consist of any or all of the following operations:-

- a) Sack rubbing with mortar and stoning with carborundum stone
- b) Cutting away the defective concrete to the required depth and shape.
- c) Cleaning or reinforcement and embedments.
- d) Roughening by sand blasting or chipping
- e) Installing additional reinforcement/welded mesh fabric
- f) Dry packing with stiff mortar
- g) Plastering, guniting, shotcreting etc
- h) Placing and compacting concrete in the void left by cutting out defective concrete.

Grouting with cement sand slurry of 1:1 mix.

#### 3.14.1.1 Finishing Unformed Surfaces

The requirements of finishes of formed surfaces are given separately under clause 3.20.7 of this specification. The Contractor is to include in his quoted rate for concrete, the provision of normal finishes in unformed surfaces which can be achieved by screening, floating, troweling etc., as and where required by the Engineer without any extra cost of the Owner. A few typical and common cases of treatment of concrete surface are cited below:-

- a) Floor

Wherever a non-integral floor finish is indicated, the surface of reinforcement concrete slab shall be struck off at the specified levels and slopes and shall be finished with a wooden float fairly smooth removing all laitance. No over troweling, to obtain a very smooth surface, shall be done as it will prevent adequate bond with the subsequent finish.



HYDERABAD

STANDARD TECHNICAL SPECIFICATION  
FOR CEMENT CONCRETE  
PLAIN AND REINFORCED

PEDC/STD.SPEC/004  
REV 00

Page 30 of 56

If desired by the Engineer, the surface shall be scored and marked without any extra cost to the Owner to provide better bond.

Where monolithic finish is specified or required, concrete shall be compacted and struck off at the specified levels and slopes with a screed, preferably a vibrating type and then floated with a wooden float. Steel trowelling is then started after the moisture film and shine have disappeared from the surface and after the concrete has hardened enough to prevent excess of fines and water to rise to the surface but not hard enough to prevent proper finishing of aberration Steel trowel ling properly done will flatten and smoothen sandy surface left by wooden floats and procedure a dense surface free from blemishes, ripples and trowel mark. A fine textured surface that is not slick and can be obtained by trowel ling the surface lightly with a circular motion after initial towelling keeping the steel trowel flat on the surface.

To provide a better grip the Engineer may instruct marking the floor in a regular geometric pattern after initial trowel ling.

**b) Beams, Columns & Walls**

If on such or any other concretes structure it is intended to apply plaster or such concrete surfaces against which brick work or other allied works are to be built. The Concrete shall hack the surface adequately as soon as the from it stripped off so that proper bond can develop pattern adequacy and details of such hacking shall meet with the approval of the Engineering who shall be informed to inspect such surfaces before they are covered up.

**3.15 Protection and curing of concrete**

i) Newly placed concrete shall be protected approved means from rain sun and wind. Concrete placed below the ground level shall be protected aghast contamination from falling earth during and after placing. Concrete placed in ground containing deleterious substances. Shall be protected from contact with such ground. Or with water draining from such ground, during placing of concrete and for a period of at least three days or as otherwise instructed by the Engineer. The ground water around newly poured concrete shall be kept to an approved level by pumping out or other adequate means of drainage to prevent floatation of flooding. Steps, as approved by the Engineer, shall be taken to protect immature concrete from damage b debris, excessive loadings, vibration, abrasion, mixing with earth or, other deleterious materials, etc, that may impair the strength and durability of the concrete.

As soon as the concrete has hardened sufficiently, it shall be covered either with sand, hession, canvas or similar materials and kept continuously wet for at least 14 (fourteen) days after final setting. Curing by continuous sprinkling of water will be allowed if the Engineer is satisfied with the adequacy of the arrangements made by the Contractor.



HYDERABAD

STANDARD TECHNICAL SPECIFICATION  
FOR CEMENT CONCRETE  
PLAIN AND REINFORCED

PEDC/STD.SPEC/004  
REV 00

Page 31 of 56

The Contractor shall remain extremely vigilant and employ proper equipment and workmen under able supervision for curing. The Engineer's decision regarding the adequacy of curing is final. In case any lapse on the part of the Contractor is noticed by the Engineer, he will inform the Contractor or his supervisor verbally or in writing to correct the deficiency in curing. If no satisfactory action is taken by the Contractor within 3 (three) hours of issuance of such instruction, the Engineer will be at liberty either to employ sufficient means through any agency to make good the deficiency and recover the cost there of from the contractor, or pay for the part where adequate curing was noticed at a reduced rate, entirely at the discretion of the Engineer.

**3.16 Reinforcement**

Mild steel round bars, cold twisted and deformed bars as medium tensile or high yield strength steel, plain hard drawn steel wire fabric etc., will be used as reinforcement as per drawings and directions.

**3.16.1 Bar Bending Schedules**

The Contractor shall submit the Engineer for approval Bar Bending Schedules with working drawing in triplicate, showing clearly the arrangements proposed by the Contractor to match available stock of reinforcing steel, within one month of receipt of the Letter of Intent or of the receipt of the relevant design drawings whichever is later. Upon receipt of the Engineer's final approval of the Bar Bending Schedule and drawings, the Contractor shall submit 6 (six) prints of the final drawings with one reproducible print after incorporating necessary modifications or corrections, for final record and distribution. Approval of such detailed drawings by the Engineer shall not relieve the Contractor of his responsibility for correctness nor of any of his obligations to meet the other requirements of the Contract.

**3.16.2 Cleaning**

All steel for reinforcement shall be free from loose scales, oil, grease, paint or other harmful matters immediately before placing the concrete.

**3.16.3 Bending**

Unless otherwise specified, reinforcing steel shall be bent in accordance with the procedure specified in IS:2502 or as approved by the Engineer. Bends and shapes shall comply strictly with the dimensions corresponding to the approved Bar Bending Schedules. Bar Bending Schedules shall be rechecked by the Contractor before any bending is done.

No reinforcement shall be bent when already in position in the work, without approval of the Engineer, whether or not it is partially embedded in concrete. Bars shall not be straightened in a manner that will injure the material. Bars shall not be



STANDARD TECHNICAL SPECIFICATION  
FOR CEMENT CONCRETE  
PLAIN AND REINFORCED

PEDC/STD.SPEC/004  
REV 00

Page 32 of 56

HYDERABAD

straightened in a manner that will injure the material. Rebinding can be done only if approved by the Engineer. Reinforcing bars shall be bent by machine or other approved means producing a gradual and even motion. All the bars shall be cold bent unless otherwise approved. Bending hot at a cherry-red heat (not exceeding 845 Deg. C) may be allowed under very exceptional circumstances except for bars whose strength depends on cold working. Bars bent hot shall not be cooled by quenching.

**3.16.4 Placing in Position**

All reinforcements shall be accurately fixed and maintained in position as shown on the drawings by such approved and adequate means like mild steel chairs and/or concrete spacer blocks irrespective of whether such supports are payable or not. Bars intended to be in contact at crossing points, shall be securely tied together at all such points by No. 20 G annealed soft iron wire or by tack welding in case of Bar larger than 25 mm dia., as may be directed by the Engineer. Binders shall be securely held. The vertical distance between successive layers of bars shall be maintained by provision of mild steel spacer bars. They should be spaced such that the main bars do not sag perceptibly between adjacent spacers. Before actual placing, the contractor shall study the drawings thoroughly and inform the Engineer in case he feels that placement of certain bars is not possible due to congestion. In such cases he should not start placing any bar before obtaining clearance from the Engineer.

**3.16.5 Welding**

Normal bond laps in reinforcement may be placed by lap or butt welding reinforcement bars, if asked by the Engineer, under certain conditions. The work should be done with suitable safeguards in accordance with relevant India Standards for welding of mild steel bars used in reinforced concrete construction as per IS:2751 and IS:456. Welded mesh fabrics conforming to IS: 1566 may also be used if specified in the Schedule of Items and Drawings.

**3.16.6 Control**

The placing of reinforcements shall be completed well in advance of concrete pouring. Immediately before pouring, the reinforcement shall be examined by the Engineer for accuracy of placement and cleanliness. Necessary corrections as directed by him shall be carried out. Laps and anchorage lengths of reinforcing bars in a lap are not of the same diameter, the smaller will guide the lap length. The laps shall be staggered as far as practicable and as that reinforcement in position do not have to bear extra load and get disturbed.

The cover for concrete over the reinforcement shall be as shown on the approved drawings unless otherwise directed by the Engineer. Where concrete blocks are used for ensuring the cover and positioning reinforcement, they shall be made of mortar not



HYDERABAD

STANDARD TECHNICAL SPECIFICATION  
FOR CEMENT CONCRETE  
PLAIN AND REINFORCED

PEDC/STD.SPEC/004  
REV 00

Page 33 of 56

leaner than 1 (one) part cement to 2 (two) parts sand by volume and cured in a pond for at least 14 (fourteen) days. The type, shape, size and location of the concrete blocks shall be as approved by the Engineer.

**3.17 Cold Weather Concreting**

When conditions are such that the ambient temperature may be expected to be 4.5 Deg. C or below during the placing and curing period, the work shall conform to the requirement of Clause 13 of IS:456 and IS:7861.

**3.18 Hot Weather Concreting**

When depositing concrete in very hot weather, the Contractor shall take all precautions as per IS:7861 and stagger the work to the cooler parts of the day to ensure that the temperature of wet concrete used in massive structures does not exceed 38 Deg. C while placing. Positive temperature control by precooling, post cooling or any other method, if required, will be specified and paid for separately.

**3.19 Concreting under water**

When it is necessary to deposit concrete under water it shall be done in accordance with the requirements of clause 13 of IS:456.

**3.20 FORM WORK**

**3.20.1 General**

If it is so desired by the Engineer, the contractor shall prepare, before commencement of actual work, designs and working drawings for form work and cantering and get them approved by the Engineer. The formwork shall conform to the shape, grade, lines, levels and dimensions as shown on the drawings:

Materials used for the formwork inclusive of the supports and cantering shall be capable of withstanding the working load and remain undistorted throughout the period it is left in service. All supports and scaffolds should be manufactured from structural or tubular steel except when specifically permitted otherwise by the Engineer.

The cantering shall be true to vertical, rigid and thoroughly braced both horizontally and diagonally. Rekers are to be used where forms are to support inclined members. The forms shall be sufficiently strong to carry without undue deformation, the dead weight of the concrete as a liquid as well as the working load, in case the Contractor wishes to adopt any other design criteria, he has to convince the Engineer about its acceptability before adopting it. Where the concrete is vibrated, the form work shall be strong enough to withstand the effects of vibration without appreciable deflection, bulging, distortion or loosening of its components. The joints in the formwork shall be sufficiently tight to prevent any leakage of slurry or mortar.



HYDERABAD

STANDARD TECHNICAL SPECIFICATION  
FOR CEMENT CONCRETE  
PLAIN AND REINFORCED

PEDC/STD.SPEC/004  
REV 00

Page 34 of 56

To achieve the desired rigidity, tie bolts, spacer blocks, tie wires and clamps as approved by the Engineer shall be used but they must in no way impair the strength of concrete or cause stains or marks on the finished surface. Where there are chances of these fixtures being embedded, only mild steel or concrete of adequate strength shall be used. Bolts passing, completely through liquid retaining walls/slabs for the purpose of securing and aligning the formwork shall not be used.

The formwork shall be such as to ensure a smooth uniform surface free from honeycombs, air bubbles, bulges, fins and other blemishes. Any blemish or defect found on the surface of the concrete must be brought to the notice of the Engineer immediately and rectified free of charge as directed by him.

For exposed interior and exterior concrete surfaces of beams, columns and wall, plywood or other approved form shall be thoroughly cleaned and tied together with approved corrosion-resistant devices. Rigid care shall be exercised in ensuring that all Colum forms are plumb and true thoroughly cross-braced to keep them so. All floor and beam centering shall be crowned not less than 8 mm in all directions for every 5 meters span. Unless specifically described on the drawings or elsewhere to the contrary, bevelled forms 25 mm by 25 mm shall be fixed in the form-work at all corners to provide chamfering of the finished concrete edges without any extra charge. The formwork should lap and be secured sufficiently at the lift joints to prevent bulges and offsets.

Temporary openings for cleaning, inspection and for pouring concrete shall be provided at the base of vertical forms and at other places, where they are necessary and as may be directed by the Engineer. The temporary openings shall be so formed that they can be conveniently closed when required, during pouring operations without leaving any mark on the concrete.

**3.20.2 Cleaning and Treatment of Forms**

All parts of the forms shall be thoroughly cleaned of old concrete, wood shavings, saw dust, dirt and dust sticking o them before they are fixed in position. All rubbish, loose concrete, chippings, shavings, saw dust etc shall be scrupulously removed from the interior of the forms before concrete is poured. Compressed air jet and/or water jet along with wire brushes, brooms etc. shall be used for cleaning. The inside surface of the formwork shall be treated with approved non-staining oil or other compound before it is placed in position. Care shall be taken that oil or other compound does not come in contact with reinforcing steel or construction joint surfaces. They shall not be allowed to accumulate at the bottom of the formwork. The oiling of the formwork will be inspected just prior to placement of concrete and redone wherever necessary.

**3.20.3 Design**

The formwork shall be so designed and erected that the forms for slabs and the sides of beams, columns and walls are independent of the soffits of beams and can be removed without any strain to the concrete already placed or affecting the remaining



HYDERABAD

STANDARD TECHNICAL SPECIFICATION  
FOR CEMENT CONCRETE  
PLAIN AND REINFORCED

PEDC/STD.SPEC/004  
REV 00

Page 35 of 56

formwork. Removing any props or repropping shall not be done except with the specific approval of the Engineer. If formwork for column is created for the full height of the column, one side shall be left open and built up in sections, as placing of concrete progress. Wedger, spacer, bolts, clamps or other suitable means shall be provided to allow accurate adjustment and alignment of the form work and to allow it to be removed gradually without jarring the concrete.

**30.20.4.1 Inspection of forms**

Casting of Concrete shall start only after the formwork has been inspected and approved by the Engineer. The concreting shall start as early as possible within 3 (three) days after the approval of the formwork and during this period the formwork shall be kept under constant vigilance against any interference. In case of delay beyond three days, a fresh approval from the Engineer shall be obtained.

**3.20.4 Removal of Forms**

Before removing any formwork, the Contractor must notify the Engineer well in advance to enable him to inspect the concrete if he so desires.

The Contractor shall record on the drawing or in any other approved manner, the date on which concrete is placed in each part of the work and the date on which the formwork is removed there from and have this record checked and countersigned by the Engineer regularly. The Contractor shall be responsible for the safe removal of the formwork and any work showing signs of damage through premature removal of formwork or loading shall be rejected and entirely reconstructed by him without any extra cost of the Owner. The Engineer may, however, instruct to postpone the removal of formwork if he considers it necessary.

Form for various types of structural components shall not be removed before the minimum periods specified herein and the removal after the minimum periods shall also be subject to the approval of the Engineer in each case.



HYDERABAD

**STANDARD TECHNICAL SPECIFICATION  
FOR CEMENT CONCRETE  
PLAIN AND REINFORCED**

PEDC/STD.SPEC/004  
REV 00

Page 36 of 56

**TABLE – VI  
SCHEDULE OF REMOVAL OF FORM**

part of Structure	Ordinary Portland Cement Concrete				Rapid Hardening Portland Cement Concrete			
	Temperature °C				Temperature °C			
	Above 40°C	40 <sup>0</sup> 20 <sup>0</sup>	20 <sup>0</sup> 5 <sup>0</sup>	Below 5 <sup>0</sup>	Above 40°C	40 <sup>0</sup> 20 <sup>0</sup>	20 <sup>0</sup> 5 <sup>0</sup>	Below 5 <sup>0</sup>
	Days	Days	Days	Days	Days	Days	Days	Days
a) Columns & Walls	2	1	1	Do not remove forms until site cured test specimen develop at least 50% of the specified 28 days 12 strength	1	1	1	Do not remove forms until site cured test specimen develop at least 50% of the specified 28 days strength
b) Beam sides	3	2	3		2	1	1	
c) Slabs, 125 mm	10	7	8		7	4	5	
d) Slabs over 125 mm thick and soffit of minor beams	18	14	16		12	8	9	
e) Soffit of main beams	24	21	22		14	10	12	

Wherever exposed surfaces of concrete can be effectively sealed to prevent loss of water, the periods specified for temperature above 40 Deg. C can be reduced to those of the temperature range of 20 Deg. C to 40 Deg. C subject to approval of the Engineer.

Construction joints in beams, if required to be provided, will be located at the middle of span according to clauses 3.13.1 (b) of this specification. In such cases, however, entire span of beam shall have to be kept supported by form work till its removal for the portion of beam, cast at a later date, is due and so approved by the Engineer.

### 3.20.5

#### Tolerance

The from work shall be so made as to produce a finished concrete true to shape, lines, levels, plump and dimensions as shown on the drawings subject to the following to lerances otherwise specified in this Specification or drawings or directed by the Engineer:

For a) Sectional dimension -  $\pm 5\text{mm}$

b) Plumb - 1 in 1000 of height



HYDERABAD

STANDARD TECHNICAL SPECIFICATION  
FOR CEMENT CONCRETE  
PLAIN AND REINFORCED

PEDC/STD.SPEC/004  
REV 00

Page 37 of 56

- c) Levels -  $\pm$  3mm before any deflection has  
Taken place

The tolerance given above are specified for local aberration in the finished concrete surface and should not be taken as tolerances for the entire structure taken as a whole or for the setting and alignment of formwork, which should be as accurate as possible to the entire satisfaction of the Engineer. Any error, within the above tolerance limits or any other as may be specially set up by the Engineer, if noticed in any lift of the structure after stripping of forms, shall be corrected in the subsequent work to bring back the surface of the structure to its true alignment.

### 3.20.6 Re-use of Forms

Before re-use, all forms shall thoroughly scraped, cleaned, joints and planes examined and when necessary required, and inside surface treated as specified here in before. Form work shall not be used/re-used if declared unfit or unserviceable by the Engineer.

### 3.20.7 Classification

Generally, the 'ordinary' class form work shall be used unless otherwise directed by the Engineer:

- a) **Ordinary** : These shall be used in places where ordinary surface finish is required and shall be composed of steel and/or approved good quality partially seasoned timber.
- b) **Plywood** : These shall be used in exposed surfaces, where a specially good finish is required and shall be made of approved brand of heavy quality plywood to produce a perfectly uniform and smooth surface conforming to the shape described in the drawing with required grain texture on the concrete.  
Re- use may only be permitted after specification and approval by the Engineer. He may also permit utilisation of used plywood for the ordinary class, if it is still in good condition.
- c) **Ornamental**: These shall be used where ornamental and curved surface are required and shall be made of selected best quality well seasoned timbers or of plywood, which can be shaped correctly.

### 3.21 Opening, Chases, Grooves, Rebates, blackouts etc.

The Contractor shall leave all openings, grooves, chase, etc. In concrete work as shown on the drawings or as specified by the Engineer.

### 3.22 Anchor Bolts, Anchors, Sleeves, Inserts, Hangers/Conduits/Pipe and Other Miscellaneous Embedded Fixtures



HYDERABAD

STANDARD TECHNICAL SPECIFICATION  
FOR CEMENT CONCRETE  
PLAIN AND REINFORCED

PEDC/STD.SPEC/004  
REV 00

Page 38 of 56

The Contractor shall build into concrete work all the items noted below and shall embed them partly or fully as directed and secure the same as may be required. The materials, if required to be supplied by the Contractor, shall be as specified and be of best quality available according to relevant Indian Standards of approved manufacture and to the satisfaction of the Engineer. Exposed surfaces of embedded materials are to be painted with one coat of approved anti-corrosive paint and / or bituminous paint without any extra cost to the Owner. If welding is to be done subsequently on the exposed surface of embedded material the paint shall be cleaned off the member to a minimum length of 50 mm beyond each side of the weld line.

Necessary templates, fixtures, supports etc. shall be used as may be required or directed by the Engineer, free of cost to the Owner.

**Items to be embedded**

- a) Inserts, hangers, anchors, frames around openings, manhole covers frames, floor clips, sleeves, conduits and pipes.
- b) Anchor bolts and plates for machinery, equipment and for structural steel work.
- c) Steel structural to be left embedded for future extension. Special connection etc.
- d) Dowel bars, etc. for concrete work falling under the scope of the contractors.
- e) Lugs or plugs for door and window frames occurring in concrete work.
- f) Flashing and jointing in concrete work.
- g) Any misc. embodiments and fixture as may be required.

Correct location and alignment as per drawings/instruction of all these embedded items shall be entirely the responsibility of the Contractor.

**3.23 Expansion and Isolation Joints**

**3.23.1 General**

Expansion and isolation joints in concrete structures shall be provided at specific places as per details indicated on the drawings. The materials and types of joints shall be as specified herein after. In case, of liquid retaining structures, additional precautions shall be taken to prevent leakage of liquids as may be specified on the drawings or as directed by the engineer. All materials are to be procured from reliable manufacturers and must have the approval of the engineer. Where it is the responsibility of the Contractor to supply the material, the Engineer may demand test certificates for the materials and/or instruct the



HYDERABAD

STANDARD TECHNICAL SPECIFICATION  
FOR CEMENT CONCRETE  
PLAIN AND REINFORCED

PEDC/STD.SPEC/004  
REV 00

Page 39 of 56

Contractor to get them tested in an approved laboratory free of cost to the Owner. Joints shall be formed true to line, level, shape, dimension and quality as per drawings and specifications. Prior approval of the method of forming the joints should be obtained from the engineer before starting the work.

### **3.23.1 Bitumen Board/Expanded Polystyrene Board**

#### **3.23.2.1 Bitumen Board**

Bitumen impregnated fibre board of approved manufacturer as per IS: 1838 may be used as fillers for expansion joints. It must be durable and waterproof. It shall be compressible and possess a high degree of rebound. The dimensions of the board should be equal to that of the joint being formed. It should preferably be manufactured in one piece, matching the dimension of the joint and not prepared by cutting to size smaller piece, from larger boards at site. At the exposed end, the joint shall be sealed with approved sealing compound to a depth of at least 25 mm after application of an approved primer. The sealing compound and the primer shall be applied as specified by the manufacturer.

#### **3.23.2.2 Expanded Polystyrene Boards**

If required, commercial quality of expanded polystyrene products commonly used for thermal insulations may also be used as filler material in expansion joints. The thickness may vary from 12 mm to 50 mm. The material will have to be procured from reliable manufacturers as approved by the Engineer. The method of installations will be similar to that recommended by the manufacturers for fixing on cold storage walls. A coat of Bitumen paint may have to be applied on the board against which concrete will be placed.

#### **3.23.2 Joint Sealing Strips**

Joint sealing strips may be provided at the construction, expansion and isolation joints as a continuous diaphragm to contain the filler material and/ or to exclude passage of water or any other material into or out of the structure. The sealing strips will be either metallic like G.I. Aluminium or Copper, or non-metallic like rubber or P.V.C.

Sealing strips will not have any longitudinal joint and will be procured and installed in largest practicable lengths having a minimum number of transverse joint. The material is to be procured from reputed manufacturers having proven records of satisfactory supply of joint strips of similar make and shape for other jobs. The jointing procedure shall be as per the manufacturer's recommendations, revised if necessary, by the Engineer. The Contractor is to supply all labour and material for installation including the material and tools required for jointing testing, protection, etc. If desired by the Engineer joints in rubber seals may have to be vulcanized.

#### **3.23.3.1 Metal Sealing Strips**



HYDERABAD

STANDARD TECHNICAL SPECIFICATION  
FOR CEMENT CONCRETE  
PLAIN AND REINFORCED

PEDC/STD.SPEC/004  
REV 00

Page 40 of 56

Metal sealing strips shall be either G.I. Aluminium or Copper and formed straight, U shaped, Z shaped or any other shape and of thickness as indicated in the drawing and schedule of items and/or as instructed by the Engineer.

The transverse joints will be gas welded using brass rods and approved flux and will be tested by an approved method to establish that it is leak proof, longer lap lengths and different method of brazing which will tender it leak proof, will be adopted by the Contractor without any additional cost to the Owner. The edges shall be neatly crimped and bent to ensure proper bond with the concrete.

a) **G.I. Strips**

G.I. Strips shall be minimum 1.5 mm thick and 150 mm in width unless specified otherwise. The Standard of Galvanising shall be as per relevant Indian Standards for heavy duty work. At the joints, the overlapping should be for a minimum length of 50 mm.

b) **Aluminium Strips**

Aluminium strips shall be minimum 10 SWG thick and 300 mm wide unless specified otherwise and shall conform to IS:737 of 19000 grade or 31000 grade (Designation as per IS: 6051. A minimum lap of 50 mm length is required at the joints.

c) **Copper Strips**

The Copper strips shall be minimum 18 SWG in thickness and 300 mm wide unless specified other wise and shall conform to the relevant Indian Standards.

It should be cleaned thoroughly before use to expose fresh surface, without any reduction in gauge. A minimum lap of 50 mm in length is required at the joints.

**3.23.3.2 Non-metallic Sealing Strips**

The will be normally in Rubber or P.V.C. joint be of shape having any combination of the following features:-

- a) Plain
- b) Central bulb
- c) Dumb-bell or flattened ends.
- d) Ribbed and Corrugated Wings
- e) V shaped



HYDERABAD

STANDARD TECHNICAL SPECIFICATION  
FOR CEMENT CONCRETE  
PLAIN AND REINFORCED

PEDC/STD.SPEC/004  
REV 00

Page 41 of 56

As these types of seals be easily handled in very lengths unlike metal strips, transverse joints will be only under unavoidable circumstances and with the specific approval of the Engineer.

The method of forming these joint, laps etc. shall be specified by the manufacturer and /or as approved by the Engineer taking particular care to match the central bulbs and the edges accurately

a) **Rubber Sealing Strips**

The minimum thickness of Rubber sealing strips shall be 3mm and the minimum width 100 mm. The actual size and shape will be as shown in drawings/schedule of items and/or as directed by the Engineer. The material will be natural rubber and be resistant to corrosion, abrasion and tear and also service. The physical properties will be generally as follows. The actual requirements may be slightly different as decided by the Engineer.

Specific Gravity	:	1.1 to 1.15
Shore Hardness	:	65 A to 75 A
Tensile Strength	:	25-30 N/Sq.mm
Maximum Safe Continuous Temperature	:	75 Deg.C
Ultimate Elongation	:	Not less then 350 %

b) **P.V.C. Sealing Strips**

The minimum thickness of P.V.C. sealing strips will be 3 mm and the minimum width 100 mm. The actual size and shape will be as shown in drawings / Schedule of items and / or as directed by the Engineer. The material should be of good quality polyvinyl Chloride highly resistant to tearing, abrasion and corrosion as well as to chemicals likely to come in contact with during use. The physical properties will generally be as follows, which will be directed by the Engineer, may very slightly:-

Specific Gravity	:	1.3 to .1. 35
Shore Hardness	:	60 A to 80 A
Tensile Strength	:	10 – 15 N/Sq.mm
Maximum Safe Continuous Temperature	:	70 Deg.C
Ultimate Elongation	:	Not less then 275 %

**3.23.4 Bitumen Compound**

When directed, the gap in expansion joints shall be thoroughly cleaned and bitumen compound laid as per manufacturer's specifications. The compound to be used shall be of approved manufacture and shall conform to the requirements of IS: 1834.

**3.23.5 Isolation Joints**



STANDARD TECHNICAL SPECIFICATION  
FOR CEMENT CONCRETE  
PLAIN AND REINFORCED

PEDC/STD.SPEC/004  
REV 00

Page 42 of 56

HYDERABAD

Strong and tough alkathene sheet or equivalent, about 1 mm in thickness and as approved by the Engineer shall be used in isolation joints. It shall be fixed by an approved adhesive compound on the cleaned surface of the already set concrete, to cover it fully. Fresh concrete shall be laid against the sheet, care being taken not to damage the sheet in any way.

### 3.23.6 Rubber Pad

Hard Foundation quality rubber pads of required thickness and shapes shall be put below machine or other foundations as shown on the drawings or as directed by the Engineer. The rubber shall have a unit weight of 1,500Kg/Cu.m., a shore hardness – 65A to 70A and be of best quality of approved manufacture, durable, capable of absorbing vibration and must be chemically inert in contact with moist or dry earth or any earth or any earth or any other deleterious material expected under normal conditions.

### 3.24 Grouting under Machinery or Structural Steel Bases

If required, grouting under base plates of machines or structural steel etc., shall be carried out by Contractor. In general, the mix shall be 1 (one) part cement and 1 (one) part sand and just enough water to make it flow as required. The areas to be grouted shall be cleaned thoroughly with compressed air jet and/or with water in locations where accumulated surplus water can be removed. Where directed by the Engineer, 6mm down stone chips may have to be used in the mix. Surface to be grouted shall be kept moist for at least 24 hours in advance. The grout shall be placed under expert supervision, so that there is no locked up air. Edges shall be finished properly. If desired by the Engineer, admixtures like Aluminium powder, 'Ironite' etc. may have to be added with the grout in proportions to be decided by the Engineer. Admixture, if directly to be added, will be measured and paid sep[separately].

### 3.25 Precast Concrete

The specification for precast concrete will be similar as for the cast-in-place concrete described herein and as supplemented in this section. All precast work shall be carried out in a yard made for the purpose.

This yard shall be dry, properly levelled and have a hard and even surface. If the ground is to be used as a soffit former of the units, it shall be paved with concrete or masonry and provided with a layer of plaster (1:2 proportions) with smooth neat cement finish or a layer of M.S. sheeting. Where directed by the Engineer, casting will have to be done on suitable vibrating table. The yard, lifting equipment, curing tank, finished material storage space etc. shall be designed such that the units are not lifted from the mould before 7 (seven) days of curing and can be removed for erection after 28 days of curing. The moulds shall preferably be of steel or of timber lined with G.I. sheet metal. The yard shall preferably be fenced.

Lifting hooks, where necessary or as directed by the Engineer, shall be embedded in correct position of the units to facilitate erection, even though they may not be shown on the drawings, and shall be burnt off and finished after erection.



HYDERABAD

STANDARD TECHNICAL SPECIFICATION  
FOR CEMENT CONCRETE  
PLAIN AND REINFORCED

PEDC/STD.SPEC/004  
REV 00

Page 43 of 56

Precast concrete units, when ready, shall be transported to site by suitable means approved by the Engineer. Care shall be taken to ensure that no damage occurs during transportation. All adjustments, levelling and plumbing shall be done as per instructions of the Engineer. The Contractor shall render all help with instruments, materials and men to the Engineer for checking the proper erection of the precast units.

After erection and alignment, the joints shall be filled with grout or concrete as directed by the Engineer. If centrings have to be used for supporting the precast units, they shall not be removed until the joints have attained sufficient strength and in no case before 14 (fourteen) days. The joint between precast roof planks shall be pointed with 1:2 cement: sand mortar where called for in the drawings.

### **3.26 Water Proofing of Concrete Structure**

#### **3.26.1 General**

Waterproofing of concrete structures shall be by either suitable extraneous treatments like applying paints, fixing bitumen felts etc. or internally by suitable design of the concrete mix, addition of suitable admixtures in the concrete or mortar at the time of mixing and/or installing water bars at the joints.

The design, material and workmanship shall conform to the relevant I.S.Codes where applicable. The Engineer's approval of the materials shall be obtained by the Contractor before procurement. If desired by the Engineer, test certificates for the materials and samples shall be submitted by the Contractor free of charge. The materials shall be of best quality available indigenously. Fresh clean and suitable for the duties called upon.

#### **3.26.2 Water Bar/Seal**

Water bearing structures and under ground structures may have water bar/seals installed at the joints. They may be either metallic rubber or P.V.C. The materials and installation will be as described under Clause 3.23.3.

#### **3.26.3 Waterproofing Admixtures**

- a) In Concrete:  
The admixtures shall be procured from reliable and reputed manufacturers and approved by the Engineer. The method of application and other details shall conform to the manufacturer's specification and /or as instructed by the Engineer. The contractor shall have the services of the manufacturer's supervisor at no extra cost to the Owner to supervise the work, if desired by the Engineer.
- b) In Plaster:  
The concrete surface, to be plastered, shall be hacked to Engineer's satisfaction, cleaned thoroughly and kept wetted for 24 hours. The plaster shall be in cement sand mortar mixed in proportion varying from 1:1 to 1:4 by volume along with the approved water



STANDARD TECHNICAL SPECIFICATION  
FOR CEMENT CONCRETE  
PLAIN AND REINFORCED

PEDC/STD.SPEC/004  
REV 00

Page 44 of 56

HYDERABAD

proofing 15 mm/layer or as per manufacturer's specification. The additive shall be of quality and type approved by the Engineer. If desired by the manufacturer's supervisor at no extra cost to the Owner. On completion, the plastered surface shall be cured continuously for a minimum period of 14 days like concrete.

#### 3.26.4 Bituminous of Tar Coating

The surface to be waterproofed shall be rendered absolutely dry, clean and dust free. The surface shall be sand papered, cleaned and completely coated with hot coal tar pitch of approved manufacture and quality as per IS: 216 (not heated above 375 Deg.F) using not less than 2 kg per Sq. M or with hot asphalt i.e., bitumen according to IS: 73 (not heated above 400 Deg.F) using not less than 1.5 kg. Per Sq. m when the first coat has completely dried up and approved by the Engineer, the second coat shall be applied in the same manner using hot less than 1.25 kg .per sq. M in case of coal tar and 1 kg per Sq. M. in case of asphalt Immediately after application of the second coat and be for it is dried up, sand shall be spread on the surface to cover it completely sufficient time shall be allowed after spreading of before back filing is done in order to allow the final coat to dry up completely.

#### 3.26.5 Bitumen Felt: Application for Tanking

This specification shall cover laying the waterproof coarse on the outside and inside of the walls and bases of structures

The materials shall conform to IS: 1322, and the workmanship to IS: 1609. The bitumen felt shall be Hessian base and/or fibre base as specified in Drawing/Schedule of Items. If required by the Contractor without charging any extra to the Owner.

Cleaning the surface, keeping it dry, providing necessary corner fillets and cement rendering and cutting chases, etc., shall be included in the rate for this item. If any protective brickwork on/against concrete sub-bases or walls are required, this will be paid extra under suitable items in the contract. A 20 years guarantee for satisfactory performances shall be given by the Contractor as well as his specialist sub- contractor jointly and severally, for this item of work. Free rectification of any defects noted in the work within this guarantee period will be carried out by the contractor even if is beyond the specified maintenance period of the contract as a whole.

#### 3.26.6 Polyethylene films: Application in Walls or base of Structures

Waterproof treatment shall be applied as outlined and as per sequence given here under.

- i) The concrete surface shall be made smooth with 12 mm cement plaster 1:6
- ii) apply hot bitumen 80/100 grade (IS 73-1961 )at the rate of 1.0 Kg/Sq m  
Minimum
- iii) Lay back poly ethylene film 250 micro (IS 2508- 1977) with cut back bitumen adhesive in overlaps over hot bitumen surface, gently pressed,



HYDERABAD

STANDARD TECHNICAL SPECIFICATION  
FOR CEMENT CONCRETE  
PLAIN AND REINFORCED

PEDC/STD.SPEC/004  
REV 00

Page 45 of 56

taking care not puncture the film.

Alternatively, the overlaps shall be sealed by an electric iron having three parallel sealing bars. A long piece of plywood is to be placed below the Polyethylene film to be heat spread a cushion for better welding of the LDPE film, with 100 mm overlap, is to be stretched. On the overlapped film another Cellophane tape is to be placed to prevent the heat heat sealer from sticking to the LDPE film After this, the electric iron is to be pressed on the overlap join for sufficient time so as to allow perfect welding. The operation is to be repeated for subsequent lengths of joints. After heat sealing, the Cellophane tape is to be removed and the joints are to be tested for leaks.

- iv) Lay 100 gm brown craft paper laminated with a layer of straight run bitumen
- v) Lay hot bitumen 80/200 grade (IS: 73-1961 )at 1.0 Kg/Sq.m minimum.
- vi) Lay 250-micron polyethylene film as second layer similar to (iii) above.
- vii) Lay second layer of 100 gm brown craft paper laminated similar to (iv) above.
- viii) Apply hot bitumen (straight run grade) to IS: 73-1961 at 1.0 Kg/Sq.m. dusted with fine sand.
- ix) Protecting with a layer of 75 mm plain cement concrete M-100, or a layer of brick laid in cement mortar 1:6. In case of wall apply a 12 mm thick plaster as shown on the drawing or a protective brick wall in 1:6 cement mortar as shown on the drawing.

#### 4.0 SAMPLING AND TESTING

##### 4.1 General

The Contractor shall carry out all sampling and testing in accordance with the relevant India Standards and as supplemented here in for the following items at his own cost unless otherwise specified in this specification. The Contractor shall get, the specimens tested in a laboratory approved by the Engineer and submit to the Engineer the test results in triplicate with in 3 (three) days after completion of the test.

##### 4.2 Cement

Representative samples will be taken from each consignment of cement received from the manufacturer/supplier for carrying out the tests for fineness (by hand sieving), setting time and compressive strengths as per IS:269. soundness Tests may also be required to be carried out if required by the Engineer. The test shall be carried out free of charge by the Owner, if Cement is supplied by him or by the Contractor is directed arrange for the supply as per the terms and conditions of the Contract. In case due to any circumstances, the agency of supply is changed in the middle of the Contract, the party who bore the original contractual obligation will carry on with the test, free of charge to the other, till the end of the works unless satisfactory 3(three ) days and 7 days test results for compressive strength are know. The Owner, Engineer and Contractor will jointly associate themselves with the tests irrespective of whether they are carried out by the Owner or the Contractor. These tsets are of great importance as



HYDERABAD

STANDARD TECHNICAL SPECIFICATION  
FOR CEMENT CONCRETE  
PLAIN AND REINFORCED

PEDC/STD.SPEC/004  
REV 00

Page 46 of 56

their results will have a bearing on the acceptance of concrete or otherwise as per the terms and conditions of the Contract.

**4.3.1 Aggregates**

The Contractor shall carry out any or all the tests aggregates as may be required by the Engineer in accordance with IS2300 (PARTS-I to VIII). The acceptance criteria of the samples tested shall be in accordance with the requirements of the relevant Indian Standards.

**4.4 Water**

Sampling and Testing of water being used for concrete works per IS:3550 will be carried out by the Contractor at regular intervals and whenever directed by the Engineer. The final acceptance criteria in case of doubt will be as per IS: 3025 & IS: 456.

**4.5 Admixture**

**4.5.1 Air Entraining Agents**

Initially, before starting to use A.E.A., relationship between the percentage of air entrained and the cylinder cube crushing strength via-a via quantity of A.E.A. used for all types of concrete will be established by the Contractor free of charge by carrying out sufficiently large number of tests. Contractor will check up free of charge, the actual presented by the Engineer, the Contractor with earlier test results.

**4.5.2 Other Admixtures**

Tests for establishing the various of any other admixtures which may be Required to be added shall be carried out by the Contractor free of charge to Owner.

**4.6 Concrete**

The sampling of concrete, making the test specimens, curing and testing procedure etc. shall be in accordance with IS:516 and IS:1199 the size of specimen being 15 cm cubes. Normally, only compression tests shall be performed but under special circumstances the Engineer may require other tests to be performed in accordance with IS:516

Sampling procedure, frequency of sampling and test specimen shall conform to Clause 14 of IS: 456.

To control the consistency of concrete from every mixing plant, slump tests and/or compacting factor tests in accordance with IS:1199 and as mentioned in Clause 3:6 of this Specification shall be carried out by the Contractor every two hours or as directed



HYDERABAD

STANDARD TECHNICAL SPECIFICATION  
FOR CEMENT CONCRETE  
PLAIN AND REINFORCED

PEDC/STD.SPEC/004  
REV 00

Page 47 of 56

by the Engineer. Slump corresponding to the test specimens shall be recorded for reference.

The acceptance criteria of concrete shall be in accordance with Clause 15 of IS:456. However, in exceptional circumstances, the Engineer may, at his discretion, accept a concrete of lower strength than specified and which is otherwise unacceptable according to IS:456.

Payment for concrete which is normally unacceptable as per the criteria laid down in IS: 456, but which has been accepted by the Engineer shall be made at a reduced rate prorata to the strength obtained.

Concrete work found unsuitable for acceptance shall have to be dismantled and replacement is to be done as per specification by the Contractor. No payment for the dismantled concrete, the relevant formwork and reinforcement, embedded fixtures etc. wasted in the dismantled portion shall be made. In the course of dismantling, if any damage is done to free of charge by the Contractor, to the satisfaction of the Engineer.

## 5.0 ACCEPTANCE CRITERIA

### 5.1 Standard Deviation

Standard deviation shall be based on test results and determination of Standard deviation shall conform to clause 14.5 of IS: 456.

### 5.2 Acceptance Criteria

The strength requirements and acceptance criteria shall conform to Clause 15 of IS:456.

### 5.3 Inspection and Core Tests

Inspection of concrete work immediately after stripping the formwork and core test of structures shall conform to Clause 16 of IS: 456.

### 5.4 Load Test

Load tests of structural members may be required by the Engineer, when the strength of test specimen results fall below the required strength as per "Load Test on parts of structures", Clause 16.5 of IS:456. If load testing is decided by the Engineer, the member under consideration shall be subjected to a test load equal to 1:25 (one and a quarter) times the specified live load user for design and this load shall be maintained for a period of 24 (twenty-four) hours before removal. The detailed procedure of the test is to be decided by the Engineer. Load tests shall not be made until the structure is at least 56 days old.

If the member shows evident failure, such changes as are necessary to make the structure adequately strong shall be made by the Contractor free of cost to the Owner.



STANDARD TECHNICAL SPECIFICATION  
FOR CEMENT CONCRETE  
PLAIN AND REINFORCED

PEDC/STD.SPEC/004  
REV 00

Page 48 of 56

HYDERABAD

Alternatively, if permitted under Statutory Regulations and at the discretion of the Engineer .the structure under test or a portion thereof may be retained as such without any modification by de-rating its load bearing capacity, provided the design criteria allows such de-rating.

A reinforced concrete beam, floor or roof shall be deemed to have passed the test if the maximum deflection at the end of 24 hours dose not exceed the deflection given in Clause 16.5 of IS: 456.

The entire cost of load testing shall be borne by the Contractor. If a portion of the structure is found to be unacceptable, it shall be dismantled and replaced by a new structure as per specification. The entire cost of dismantling and replacement and restoration of the site being borne by the Contractor.

If in the course of dismantling, any damages done to the embedded items and or other adjacent to the satisfaction of the Engineer.

## 6.0 RATES

The rate for any item in the schedule, unless specifically excluded in the contract, shall be deemed to include the cost of all materials consumed or used in the work or incidental to it a labour, tools, plants, equipment, templates, supports, scaffolds approaches, security, and safety measures, power, fuel, lubricants, storage, handing transport, testing, insurances, taxes overheads, profits etc., the various items of work which are to be provided are mentioned under Clause 2.1 and elsewhere in this specification. If no separate item is provided for any such wok in the schedule of items. It is implied that the contractor shall not claim for any of the connected items of the schedule viz., detailed drawings and drawings of formwork in the item of from work of concrete etc., rate for R.C.C. items shall include for carrying out specimen tests as per specifications.

## 7.0 METHOD OF MEASUREMENT

### 7.1 Concrete

- a) Actual volume of work as executed or as per drawings issued, whichever is less shall be measured in Cu.M. Deductions for openings, conduits, pipes, ducts pockets, chases etc. shall be made, provided they are larger then 0.1 sq. M. in area each.

No deduction shall be made for embedded fixtures including reinforcements, sleeves, anchor bolts and similar items.

- b) Precast concrete work shall be measured in the same way as specified in foregoing paragraph. No separate payment shall be made for formwork. Lifting hook where required in the design, shall be treated as reinforcement steel and paid accordingly. Payment shall be due only after erection, grouting and curing of the precast units in proper position unless otherwise provide for



HYDERABAD

STANDARD TECHNICAL SPECIFICATION  
FOR CEMENT CONCRETE  
PLAIN AND REINFORCED

PEDC/STD.SPEC/004  
REV 00

Page 49 of 56

in the contract. All breakages and damages of the precast units will be to the Contractor's account and shall be replaced free of charge to the Owner.

**7.2 Admixture**

Admixture will be measured on the basis of theoretical requirement or actual consumption, whichever is less.

**7.3 Reinforcement**

- a) Bar or any other type of reinforcement used like Hard drawn steel Wire fabric etc. for reinforced shall be measured by weight in tonnes. The weight will be arrived at by multiplying the actual or theoretical length; whichever is less, by the sectional weights. In case the Owner issues the reinforcing steel, the section weights will be the same as were applied at the time of issue. In case the steel is to be supplied by the contractor, the sectional weight to be adopted will be the I.S. Sectional Weight or as per actual which will be arrived at by accurately measuring representative samples as directed by the Engineer, whichever is less.
- b) Standard hooks; cranks, bonds, authorised laps etc. shall be measured.
- c) Lap welding or butt welding if permitted will be, measured diameter wise per Joint. The actual length of steel in lap will be measured separately in case of lap welding. The rate quoted for the smaller size bar will be applied in case of joint between two bars of different diameters.
- d) Separator pieces between two or more layers of steel shall be measured.
- e) No payment shall be made for binding wires, spacer block, supports, chairs, hangers, etc. of height 300 mm and less, required of keeping the steel in position unless otherwise specified in the contract. For supporting horizontal reinforcement at heights larger than 300 mm support drawings will be prepared by the Engineer, or as actually placed, whichever is less, at the same rate as for Reinforcement.
- f) No extra will be paid for modification of already embedded reinforcement, if required due to faulty fabrication or placement.
- g) Dowels neither shown on the drawings not instructed by the Engineer, but required for construction facilities and/or sequence, shall not be measured.

**7.4 Form work**

- a) Formwork shall be measured as the actual surface in contact with the concrete and paid in Sq.M unless included in the rate for concrete.



HYDERABAD

STANDARD TECHNICAL SPECIFICATION  
FOR CEMENT CONCRETE  
PLAIN AND REINFORCED

PEDC/STD.SPEC/004  
REV 00

Page 50 of 56

- b) Formwork shall not be measured separately for precast concrete work which shall be included in the concrete rates.
- c) No payment for form work or any other requirement in construction joints shall be made.
- d) Openings upto 0.1 Sq.M shall be neglected as if non-existent for the purpose of form work measurement.
- e) No extra measurement or payment shall be made for making the form work waterproof or for supports, scaffolding, centering approaches, etc.
- f) No measurement shall be taken for the form work in pockets, openings, chases etc. in concrete if the cross-sectional area is less than or equal to 0.1 Sq.M. in each case if the cross-sectional area of any opening exceeds 0.1 Sq.M the form work shall be measured under appropriate classification.
- g) Fixing and removing pockets and openings of sectional area less than 0.1 Sq.M. shall be measured on number basis and paid separately.

**7.5 Anchor Bolts, Anchor Sleeves, Inserts, Hangers, Conduit Pipes and Other Miscellaneous Embedded Fixtures**

- a) These will be measured on theoretical weight basis of the complete insert handled by the Contractor irrespective of the amount of insertion. Where theoretical weight cannot be assessed satisfactorily, the actual weight shall be allowed under certification of the Engineer.
- b) No extra shall be to be paid for templates and other arrangements required to secure these in position. The protection of these materials with proper anticorrosive paints/grease and covering with gunny bags against any damages till the structure is handed over, shall be the responsibility of the Contractor at no extra cost.
- c) Any 'boxing' left for inserts, etc. during construction, for facility of the Contractor's work, and later on filled in by the same Contractor after placing the inserts shall be considered for measurement purpose, as if the inserts, etc. were placed before concreting.
- d) No extra payment shall be made for cleaning of the inserts, etc. required for bond with the concrete.

**7.6 Expansion and Isolation Joints**

- a) Expansion and isolation joints will be measured and paid on area basis. The drawings and or schedule of items will describe the thickness. Painting, filling material, sealing, strips, metal fixtures, inserts, etc. to be used in the joint.



HYDERABAD

STANDARD TECHNICAL SPECIFICATION  
FOR CEMENT CONCRETE  
PLAIN AND REINFORCED

PEDC/STD.SPEC/004  
REV 00

Page 51 of 56

- b) Formwork for the 'leading side' of the joint will be measured and paid under the relevant item. No payment for the formwork for the 'following side' will be made even if the Contractor is required to use from work for constructional facilities.
- c) Joints sealing strips made out of Copper, Aluminium or G.I.or P.V.C.or rubber, will be measured and paid on area basis under relevant items. Rubber pads below foundation will be measured on area basis under the relevant item.
- d) Any other fixtures and inserts like dowels, installed as per drawing, riding plates etc., will be measured and paid if under the respective items of the schedule of Items.
- e) All other work like installing Bitumen coating, Bitumen boards, Expanded polystyrene Boards, Alkathene sheets, Bitumen filler etc. and trimming the top , repair, finishes and other connected items will be deemed to be included in the unit rate for expansion/Isolation joints.

**7.7 Joints Seals: G.I. Copper, Aluminium, Rubber or P.V.C.**

All seals, whether used as water bars or in expansion or Isolation Joints shall be measured as joint seals and on area basis. In case of Metallic seals like G.I. copper or Aluminium the developed area will be measured. In case of Rubber and P.V.C. seals also, developed area will be measured but the central bulb, corrugation ribs etc. will be neglected. In all cases laps will not be measured.

**7.8 Rubber pad**

Rubber pads will be measured on area basis. The theoretical or actual area, whichever is less, will be recorded.

**7.9 Grouting under Base Plates etc.**

Grouting shall be measured on theoretical volume basis neglecting the volume of embedded items. The cost shall include the cost of backing the old concrete Plus necessary from work if any Edges of the grouting shall be measured equal even if chamfered. Necessary curing shall also be included Admixtures. If added, Will be measured and paid separately under the relevant items.

**7.10 Water proof Plaster**

The measurement will be no finished square area basis. The thickness, method of applications, waterproofing additive to be used etc. will be specified in the specification/drawings/schedule of items.

The waterproofing additive will be measured and paid separately under admixtures (Clause 7.2 ) .No deduction will be made for opening less then 0.1 Sq .m in area each.



HYDERABAD

STANDARD TECHNICAL SPECIFICATION  
FOR CEMENT CONCRETE  
PLAIN AND REINFORCED

PEDC/STD.SPEC/004  
REV 00

Page 52 of 56

**7.11 Bitumen Coating/Tar Coating**

These shall be measured on next useful area, neglecting openings up to 0.1 Sq.M in area each.

**7.12 Bitumen Felt**

Bitumen felt waterproofing shall be measured nett on area of structure cover, neglecting openings up to 0.1 Sq.M . in area each, measuring only once for the completed work and once for each layer.

**7.13 Polyethylene Film**

Polyethylene Film waterproofing shall be measured nett on area of structure covered, neglecting openings up to 0.1 Sq.M. in area each, measuring only once for the completed work and not once for each layer.

**7.14 Tests**

- a) Tests on concrete specimens shall not be paid for separately. The specimen shall be either in the form of 15 cubes or 15 cm dia. 30 cm along cylinders. No separate measurement shall be made for column of concrete used in the specimen or for the mould.
- b) No payment shall be made for tests carried out for approval of samples or different materials in accordance with the specification.
- c) Load Test, if required to be made as per terms and conditions of the contract, shall not be paid.

**8.0 LIST OF IS: CODES AND STANDARDS FOR REFERANCE**

All work under this specification shall, unless specified other wise, conform to the latest revisions and/or replacements of the following or any other Indian Standard Specifications and Codes of practice. In case any particular aspect of work is not specifically covered by Indian standard Specifications, any other standard practice, as may be specified by the Engineer, shall be followed: -

- |          |   |   |
|----------|---|---|
| IS : 73  | - | Indian Standard Specification for paying Bitumen.                         |
| IS : 216 | - | Indian Standard Specification for Coal Tar Pitch.                         |
| IS : 226 | - | Indian Standard Specification for Structural Steel (Standard quality).    |
| IS : 269 | - | Indian Standard Specification for Ordinary, and Low Heat Portland Cement. |



HYDERABAD

STANDARD TECHNICAL SPECIFICATION  
FOR CEMENT CONCRETE  
PLAIN AND REINFORCED

PEDC/STD.SPEC/004  
REV 00

Page 53 of 56

- IS:8112 - 43 grade ordinary portland cement.
- IS : 383 - Indian Standard Specification for Coarse and Fine Aggregates from Natural Sources for Concrete..
- IS : 432 - Indian Standard Specification for Mild Steel and Medium Tensile Steel Bars and Hard Drawn Steel Wire for concrete Reinforcement.
- IS : 455 - Indian Standard Specification for Slag Cement.
- IS :456 - Indian Standard Code of Practice for Plain and Reinforced Concrete.
- IS : 457 - Indian Standard Code of Practice for General Construction of plain and Reinforced Concrete for Dams and other Massive Structures.
- IS : 516 - Indian Standard Specification for Methods of Test for Strength of Concrete.
- IS :1139 - Indian Standard Specification for Mild Steel and Medium Tensile Steel Bars and High yield Strength Steel; Deformed Bars for concrete Reinforcement.
- IS : 1199 - Indian Standard Specification for Methods of Sampling and Analysis of Concrete.
- IS : 1200 (part-II) - Indian Standard Specification for Method of measurement Cement Concrete work.
- IS : 1200 (part-V) - Indian Standard Specification for Method of measurement Form work.
- IS : 1322 - Indian Standard Specification for Bitumen Felts for waterproofing and Damp-proofing.
- IS : 1489 - Indian Standard Specification for Portland – Pozzolana Cement.
- IS : 1566 - Indian Standard Specification for Methods for sampling and Analysis of Concrete.
- IS : 1609 - Code of practice for laying Damp-Proof Treatment using Bitumen Felts.
- IS : 1786 - Indian Standard Specification for Cold-twisted Steel Bars for Concrete Reinforcement.
- IS : 1791 - Indian Standard Specification for Batch Type Concrete Mixers.



HYDERABAD

STANDARD TECHNICAL SPECIFICATION  
FOR CEMENT CONCRETE  
PLAIN AND REINFORCED

PEDC/STD.SPEC/004  
REV 00

Page 54 of 56

- IS : 2185 - Indian Standard Specification for Hollow Cement Concrete Blocks.
- IS : 2210 - Indian Standard Specification for Design of Reinforced Concrete shall Structures and Folded plates.
- IS : 2386 - Indian Standard Specification for methods of Test for Aggregates for Concrete – part-I to VIII.
- IS : 2502 - Indian Standard Code of practice for Bending and Fixing of Bars for Concrete Reinforcement.
- IS : 2505 - Indian Standard Specification for Concrete Vibrators. Immersion Type.
- IS ; 2506 - Indian Standard Specification for Screed Board Concrete Vibrators.
- IS : 2514 - Indian Standard Specification for Concrete vibrating Tables.
- IS : 2722 - Indian Standard Specification for portable Swing Weigh Batches for Concrete ( Single and Double Bucket type ).
- IS : 2751 - Code of practice for Welding of Mild Steel Bars used for Reinforced Concrete Construction.
- IS : 2770 - Indian Standard Specification for Method of Testing Bond in Reinforced Concrete Construction.
- IS : 3025 - Indian Standard Specification for methods of sampling and Test (physical and Chemical ) for Water used in Industry.
- IS : 3201 - Indian Standard Specification for Design and construction of precast Concrete Trusses.
- IS : 3370 - Indian Standard Specification for Code of practise for Concrete structures for Storage of Liquids.
- IS ; 3550 - Indian Standard Specification for Method of Test for Routine Control for water used in Industry.
- IS : 3558 - Code practice for use of Imersion Vibrator for Consolidating Concrete.
- IS : 3590 - Indian Standard Specification for Load Baring Light Weight Concrete Blocks.
- IS : 3696 - Safety code for Scaffolding and Ladders.



STANDARD TECHNICAL SPECIFICATION  
FOR CEMENT CONCRETE  
PLAIN AND REINFORCED

PEDC/STD.SPEC/004  
REV 00

Page 55 of 56

HYDERABAD

- |                          |   |   |
|--------------------------|---|---|
| IS : 3812                | - | Indian Standard Specification for fly Ash for use as Admixture for Concrete.  |
| IS : 4031                | - | Indian Standard Specification for Method of Tests for Hydraulic Cement.   |
| IS : 4031                | - | Indian Standard Specification for Method of Test for Hydraulic Cement.  |
| IS : 4082                | - | Indian Standard Specification for Recommendation on Stacking and Storage of Construction Materials at site.             |
| IS : 4090                | - | Indian Standard Specification for Design of Reinforced Concrete Archs.  |
| IS : 4634                | - | Indian Standard Specification Method of Testing performance of batch- type Concrete Mixes.                              |
| IS : 4656                | - | Indian Standard Specification for From Vibrators for Concrete.  |
| IS : 4925                | - | Indian Standard Specification for Concrete Batching and mixing Plant.   |
| IS : 4926                | - | Indian Standard Specification for read mixed Concrete.  |
| IS : 4990                | - | Indian Standard Specification for Plywood for Concrete Shuttering work.   |
| IS : 4991                | - | Indian Standard Specification for Blast Resistant Design of Structure for Explosion above ground.                       |
| IS : 4995<br>Part I & II | - | Indian Standard Specification for Design of reinforced Concrete Bins for the Storage of granular and powdery Materials. |
| IS : 4998                | - | Indian Standard Specification for Design of reinforced Concrete Chimneys.   |
| IS : 5512                | - | Indian Standard Specification for Flow table for use in Testes of Hydraulic Cement and Pozzolan Materials.              |
| IS : 5513                | - | Indian Standard Specification for Vie at Apparatus  |
| IS : 5515                | - | Indian Standard Specification for Compaction factor Apparatus.  |
| IS : 5751                | - | Indian Standard Specification for precast concrete Copying Blocks.  |



HYDERABAD

STANDARD TECHNICAL SPECIFICATION  
FOR CEMENT CONCRETE  
PLAIN AND REINFORCED

PEDC/STD.SPEC/004  
REV 00

Page 56 of 56

- IS : 5816 - Indian Standard Specification for method of Test for Splitting Tensile Strength of concrete Cylinders.
- IS : 5891 - Indian Standard Specification for Hand Operated Concrete Mixers.
- IS : 6452 - Indian Standard Specification for High Aluminium Cement for Structural Use.
- IS : 6909 - Indian Standard Specification for super-sulphated Cement.
- IS : 6923 - Indian Standard Specification for method of Test for Performance of Screed Board Concrete Vibrators.
- IS : 5891 - Indian Standard Specification for Hand Operated Concrete Mixers.
- IS : 6452 - Indian Standard Specification for High Aluminium Cement for Structural Use.
- IS : 6909 - Indian Standard Specification for super-sulphated Cement.



**STANDARD TECHNICAL SPECIFICATION  
FOR FABRICATION OF STRUCTURAL  
STEEL WORK**

PEDC/STD.SPEC/005  
REV 00

Page 1 of 25

HYDERABAD

# FABRICATION OF STRUCTURAL STEEL WORK

REV. NO.	PRAPARED	APPROVED	DATE

**COPYRIGHT AND CONFIDENTIAL**

The information on this document is the property of BHARAT HEVY ELECTRICAL LTD.It must not be used directly or indirectly in any way detrimental to the interest of the Company.



# STANDARD TECHNICAL SPECIFICATION FOR FABRICATION OF STRUCTURAL STEEL WORK

PEDC/STD.SPEC/005  
REV 00

Page 2 of 25

HYDERABAD

## 1.0.0 SCOPE

This specification covers supply fabrication, testing, painting and delivery to site of structural steelwork including supply of all consumable stores and rivets. Bolts, nuts, washers, electrodes and other materials required for fabrication and field connections of all structural steelwork covered under the scope of the contract.

## 2.00.0 GENERAL

### 2.1.0 WORK TO PROVIDED FOR BY THE CONTRACTOR

The work to provided for by the contractor, unless specified otherwise. Shall include but not be the following.

- a) Furnish all labour, supervision, services including facilities as required under statutory labour regulations, materials, equipment, tools and plants, transportation, etc, required by the Engineer
- b) Prepare and submit working drawing showing the approaches, slope, beam, shoring, sumps for dewatering, including drains and outfall for drainage, space for temporary stacking of spoil, disposal area, fencing, etc and all other details as may be required by the Engineer.
- c) To carry out sampling and testing and submit to the Engineer, results of soil compaction tests if required by the Engineer to assess the degree of compaction.
- d) Construction, maintenance and removal after completion of Magazine of proper capacity as well as design for storing of explosives required for blasting work to be carried out scope of this tender.

### 2.2.0 WORK TO PROVIDED FOR BY OTHERS.

No work under this specification will be provided by any agency other than the Contractor unless specifically mentioned elsewhere in the Contract

### 2.3.0 CODES AND STANARDS.

All works under this specification, unless specified otherwise shall conform to the Latest revision and /or replacement of the following or any other Indian Standard Specifications and codes of practice. In case any particular aspect of work is no Covered specially by Indian Standard Specification any other standard practice as

May be specified by the Engineer shall be followed: -

IS: 226: Structural steel (Standard Quality)

IS: 800: Code of practice for use of steel in general building construction

IS:806: Code of practice for use of steel tubes in general building construction

IS:808: Rolled steel beams channels and angle sections



## STANDARD TECHNICAL SPECIFICATION FOR FABRICATION OF STRUCTURAL STEEL WORK

PEDC/STD.SPEC/005  
REV 00

Page 3 of 25

HYDERABAD

- IS:813: Scheme of symbols for welding
- IS:814: Covered electrodes for metal are welding of structural steel
- IS:815: Classification and coding of covered electrodes for metal are welding mild steel and low ally high tensile steel.
- IS:816: Code of practice for use of metal are welding for general construction in mild steel
- IS:817 : Code of practice for training and testing metal are welders.
- IS:818: Code of practice for safety, and health requirements in electric and gas welding and cutting operations.
- IS:822: Code of practice for inspection of welds.
- IS:9595: Recommendations for metal are welding of carbon and carbon manganese steel:
- IS:919: Recommendations for limits and fits for Engineer.
- IS:961:Structural Steel (High tensile)
- IS:1148: Rivets bars for structural purposes.
- IS:1149:High tensile rivets bars for structural purposes
- IS:1161: Steel Tubes for structural purposes
- IS:1200: Method of measurement of steelwork and ironwork (Part-B)
- IS:1239: Mild Steel Tubes
- IS:1363: Black hexagon bolts, nuts and lock nuts (dia. 6 to 30mm) and black hexagon screws (dia 6 to 24mm)
- IS:1363: Black hexagon bolts, nuts and lock nuts (dia. 6 to 30mm) and black hexagon screws (dia 6 to 24mm)
- IS 1346: Precision and semi-precision hexagon bolts, screws, nuts and locknuts.(dia 6 to 24 mm
- IS:1367: Technical supply conditions for threaded fasteners
- IS:1442: Covered electrodes for the metal are welding of high tensile structural steel.



## STANDARD TECHNICAL SPECIFICATION FOR FABRICATION OF STRUCTURAL STEEL WORK

PEDC/STD.SPEC/005  
REV 00

Page 4 of 25

HYDERABAD

IS:1600: Method for tensile testing of steel products other than sheet strip, wire and tube

IS1730: Dimensions for steel plates, sheet and strip for structural and general engineer purposes.

IS: 1731: Dimensions for steel flats for structural and general engineering Purposes.

IS: 1852: Rolling and cutting tolerance for hot-rolled steel products

IS:1977: Structural steel (Ordinary quality) St-42-0

IS:2062: Structural steel (fusion welding quality )

IS:2074: Ready mixed paint red oxide Zinc chromate painting

IS:2629: Recommended practice for Hot – Dip Galvanising of Iron and Steel

IS:2633: Method for testing uniformly of coating on Zinc Coated Articles

IS:3757: High Tensile Fraction Grip bolts

IS:4759: Specifications for Hot – Dip Zinc coatings on structural Steel and other Allied products

IS 7215: Tolerance for fabrication of steel structures

### 2.4.0 CONFORMITY WITH DESIGNS.

Except where the standard connection details are furnished, the contractor shall design all connection, supply and fabricate all steelwork and furnish all connection materials in accordance with the approved drawings and/or as instructed by the Engineer keeping in view the maximum utilization of the available sizes and sections of steel materials. The methods of painting, marking, packing and delivery of all fabricated materials shall be in accordance with the provisions of the contract and/or as approved by the Engineer. Provision of all relevant Indian standard Specifications and codes of Practice shall be followed unless otherwise specified in the contract

### 2.5.0 MATERIALS TO BE USED

#### 2.5.1 GENERAL

All steel material required for the work will be supplied by the contractor unless otherwise specified elsewhere in the contract. The materials shall be free from all imperfections, mill scales slag intrusions, laminations, pitting, rusts etc. that may



## STANDARD TECHNICAL SPECIFICATION FOR FABRICATION OF STRUCTURAL STEEL WORK

PEDC/STD.SPEC/005  
REV 00

Page 5 of 25

HYDERABAD

impair their strength, durability and appearance all materials shall be of tested quality only unless otherwise permitted by the Engineer and/ of Consultant. If desired by the Engineer. Test Certificates in respect of each consignment shall be submitted in triplicate. Whenever the materials are required to be used from unidentified stocks. If permitted by the Engineer. A random sample shall be tested at an approved laboratory from each lot of 50 tonnes or less of any particular section.

The arc welding electrodes shall conform to the relevant Indian Standard Codes of Practice and Specifications and shall be of heavily coated type and the thickness of the coating shall be uniform and concentric with each container of electrodes, the manufacturer shall be uniform and concentric with each container of electrodes, the manufacturer shall furnish instructions giving recommended voltages and amperage (polarity in case of D.C supply) for which the electrodes are suitable.

### 2.5.2 STEEL

All steel materials to be used in construction within the purview of this specification shall comply with any of the following Indian Standard Specifications as may be applicable.

- 1) IS 226 - Structural steel (Standard quality)
- 2) IS 961 - Structural steel (high Tensile)
- 3) IS 1977 - Structural steel (Ordinary quality) St-42-0
- 4) IS 2062 - Structural steel ( Fusion Welding Quality)

In case of imported steel materials being used, these shall conform to specifications equivalent to any of the above as may be applicable.

### 2.5.3 Rivet Steel

All rivets steel used in construction within the purview of this Specification shall comply with one of the following Indian Standard Specifications as may be applicable

- 1) IS 1148 – Rivet Bars for Structural purpose

IS 1149- High tensile rivet bars for structural for purposes where high tensile steel is specified for rivets, steps shall be taken on ensure that the rivets are so anufactured that they can be driven and heads formed satisfactorily without the physical properties of steel being impaired.

### 2.5.4 ELECRODES

All electrodes to be used the Contract shall comply with any of the following Indian Standard Specifications as may be applicable:-



## STANDARD TECHNICAL SPECIFICATION FOR FABRICATION OF STRUCTURAL STEEL WORK

PEDC/STD.SPEC/005  
REV 00

Page 6 of 25

HYDERABAD

IS:814: Covered electrodes for metal arc welding of structural steel

IS:815: Classification and coding of covered electrodes for metal arc welding mild steel and low alloy high tensile steel.

IS:1442: Covered electrodes for the metal arc welding of high tensile structural steel.

### 2.5.5 BOLTS AND NUTS

All bolts and nuts shall conform to the requirements of Indian Standard Specification IS:1367: Technical supply conditions for threaded fasteners.

Materials for Bolts and nuts under the purview of this contract shall comply with any of the following Indian Standard Specifications as may be applicable.

a) Mild steel all mild steel for bolts and nuts when tested in accordance with the following Indian Standard, Specification shall have a tensile strength of not less than  $44\text{kg/mm}^2$  and a minimum elongation of 23 per cent on a gauge length of  $5.6A$ , Where  $A$  is the cross sectional area of the test specimen:-

- 1) IS:1367: Technical supply conditions for threaded fasteners.
- 2) IS:1600: Method for tensile testing of steel products other than sheet strip, wire and tube.

b) High Tensile Steel (Structural Quality) The material used for the manufacture of high tensile steel bolts and nuts shall have a minimum tensile strength  $58\text{kg/mm}^2$ . Other mechanical properties shall conform to grade HT of IS 961.

c) High Tensile Steel (Special Quality). The material used for the manufacture of special quality high tensile steel bolts and nuts shall have the mechanical properties appropriate to the particular class of steel as set out in IS:1367 or as approved by the Engineer.

### 2.5.6 WASHERS

Washers shall be made of steel conforming to any of the following Indian Standard Specifications as may be applicable under the provisions of the Contract:-

- 1) IS: 226: Structural steel (Standard Quality)
- 2) IS:961: Structural Steel (High tensile)
- 3) IS:1977: Structural steel (Ordinary quality) St-42-0

### 2.5.7 PAINTS



## STANDARD TECHNICAL SPECIFICATION FOR FABRICATION OF STRUCTURAL STEEL WORK

PEDC/STD.SPEC/005  
REV 00

Page 7 of 25

HYDERABAD

Paints to be used for shop coat of fabricated steel under the purview of this contract shall conform to the Indian to Standard Specifications IS:2074: Ready mixed paint red oxide Zinc chromate painting.

### 2.6.0 STORAGE OF MATERIAL

#### 2.6.1 GENERAL

All materials shall be so stored as to prevent deterioration and to ensure the preservation of their quality and fitness for the work. Any material which has deteriorated or has been damaged shall be removed from the contractor's yard immediately, failing which, the Engineer shall be at liberty to get the material removed and the cost incurred thereof shall be realised from the Contractor. The Contractor shall maintain up to date accounts in respect of receipt, use and balance of all sizes and sections of steel and other materials. In case the fabrication is carried out in contractor's fabrication shop outside the plant site where other fabrication works are also carried out, all materials meant for use in this contract shall be stacked separately with easily identifiable marks.

#### 2.6.2 STEEL

The steel to be used in fabrication and the resulting cut-pieces shall be stored in Separate stacks off the ground section wise and lengthwise so that they can be easily inspected. Measured and accounted for at any time. If required by the Engineer, the materials may have to be stored under cover and suitably painted for protection against weather.

#### 2.6.3 ELCTRODES

The electrodes for electric arc welding shall be stored in properly designed racks, separating different types of electrodes in distinctly marked compartments. The electrode shall be kept in dry and warm condition if necessary by resorting to heating.

#### 2.6.4 BOLTS, NUTS AND WASHERS

Bolts, nuts and washers and other fastening materials shall be stored on racks of the ground with a coating of suitable protective oil. These, shall be stored in separate gunny bags or compartments according to diameter, length and quality.

#### 2.6.4 PAINTS

Paints shall be stored under cover in air tight containers paints supplied in sealed containers shall be used up as possible once the container is opened.

### 2.7.0 QUALITY CONTROL

The Contractor shall establish and minimum quality control procedures for different items of work and materials to the extent the deems necessary to ensure that all work is performed



## STANDARD TECHNICAL SPECIFICATION FOR FABRICATION OF STRUCTURAL STEEL WORK

PEDC/STD.SPEC/005  
REV 00

Page 8 of 25

HYDERABAD

in accordance with this specification. In addition to the Contractor's quality control procedures, materials and workmanship at all times shall be subjected to inspection by the Engineer or Engineer's representative. As far as possible, all inspection by the engineer or Engineer's representative shall be made at the Contractor shall co-operative with the Engineer or Engineer's representative in permitting access for inspection to all places where work is being done and in providing free of cost all necessary help in respect of tools and plants, instrument, labour and materials required to carry out the inspection. The inspection shall be so scheduled as to provide the minimum interruption to the Contractor.

Materials or workmanship not in reasonable conformance with the provisions of this Specification may be rejected at any time during the progress of the work.

The quality control procedure shall cover but not limited to the following items of works:-

- 1) Steel - Quality. manufacturer's test certificates, test reports of representative samples of materials from unidentified stocks if permitted to be used.
- 2) Rivets, Bolts, Nuts & Washers - Manufacturer's certificate, dimension checks, material testing.
- 3) Electrodes - Manufacturer's certificate, thickness and quality of plus coating.
- 4) Welders - Quality Tests.
- 5) Welding sets - Performance Tests.
- 6) welds - Inspection, x-ray. Ultrasonic tests.
- 7)Paints - Manufacturer's certificate, physical inspection reports.
- 8) Galvanizing - Tests in accordance with IS: 263 Method for testing uniformity of coating of Zinc Coated Articles and IS 4759: Specifications for Hot – Dip Zinc coatings on structural Steel and other Allied products

### 2.8.0 STANDARD DIMENSIONS, FORMS AND WEIGHTS

The dimensions, forms, weights and tolerances of all rolled shapes rivets, bolts, nuts, studs, washers etc. and other members used in the fabrication of any structure shall, wherever applicable, conform to the requirements of the latest relevant Indian Standards, wherever they exist, or, in the absence of Indian Standards, to other equivalent standards.

### 2.9.0 SHOP DRAWINGS



## STANDARD TECHNICAL SPECIFICATION FOR FABRICATION OF STRUCTURAL STEEL WORK

PEDC/STD.SPEC/005  
REV 00

Page 9 of 25

HYDERABAD

The contractor shall within 15 days after the award of the Contract submit to the Engineer the Schedule of Fabrication and erection of structural steel work for approval. He shall, within 15 days after the award of the contract start to for approval. The shop drawings based on the Design Drawings furnished to him and, before proceeding with in fabrication work, shall get the said shop drawings approved in accordance with the contract.

The sequence of submission of shop drawings for approval shall match with the approved fabrication and erection schedule. The approval for the shop drawings will be accordance only towards general conformity with the design requirements as well as specifications and will ensure the correctness of general arrangement for centreline dimensions and level, Section sizes, and adequacy of connections including splice joints as to the no. of bolts, welds length, size of gusset/ end plated. The correctness of all other details like cutting lengths, matching of holes, notch dimensions, match markings, bill of materials, bolt list etc. will be entirely the contractor's responsibility. The approval of the drawing however shall not relieve the contractor of his sole responsibility in carrying out the work correctly and fulfilling the complete requirements of contract documents.

The shop drawings shall include but not be limited to the following:-

- a) Assembly drawings giving exact sizes of the sections to be used and identification marks of the various sections.
- b) Dimensional drawings of base plates, foundation bolt location etc.
- c) Comparison sheet to show that the proposed alternative section, if any, are as strong as the original sections shown on the Design Drawings.
- d) Complete Bill of Materials and detailed drawings of all sections as also their billing weights.
- e) Any other drawings or calculations that may be required for the clarification of the works or substituted parts thereof

The preparation of shop drawings shall not be submitted without prior approval of Engineer. These drawings shall give all the necessary information for the fabrication. Erection and painting of the steelwork in accordance with the provisions of this Specification shop drawings shall be made in accordance with the best modern practice and with due regard to sequence, speed and economy in fabrication and erection. Shop drawings shall give complete information necessary for fabrication of two various components of the steelwork, including the location. Type, sizes and extent of welds. These shall also clearly distinguish between shop and field rivets, bolts and welds and specify the class of bolts and nuts The drawings shall be drawn to a scale large enough to covey all the necessary information adequately. Notes on the shop drawings shall indicate those joints or groups of joints in which it is particularly important that the welding sequence and technique of welding symbols used shall be in accordance with the requirements of the Indian Standard Specification.

IS:813: Scheme of symbols for welding shall be consistent throughout Weld lengths called for on the drawings shall mean the net effective length.

The Contractor shall be responsible for and shall pay for any alterations of the work due to any discrepancies, errors or omissions on the drawings or other particulars supplied by him. Whether such drawings or other particulars have been



## STANDARD TECHNICAL SPECIFICATION FOR FABRICATION OF STRUCTURAL STEEL WORK

PEDC/STD.SPEC/005  
REV 00

Page 10 of 25

HYDERABAD

duly approved or not in accordance with the Contact, provided that such particulars on the Design furnished to the Contractor. In the Contractor. In the latter case, the Contractor will be paid for any alteration that has to be made after materials have been fabricated by the Contactor.

### 3.0.0 WORKMANSHIP

#### 3.1.0 FABRICATION

##### 3.1.1 GENERAL

All workmanship shall be equal to the best practice in modern structural shops, and shall conform to the provisions of the Indian Standard IS:800: Code of practice for user of steel tubes in general building construction and other relevant Indian Standards or Equivalent.

##### 3.1.2 STRAIGHTENING MTERIAL

Rolled materials before being laid off or worked, must be clean, free from sharp kinks, bends or twists and straight within the tolerances allowed by the Indian Standard Specification IS: 1852: Specification Rolling and cutting tolerance for hot-rolled steel products. If straightening it necessary, it may be done by mechanical means or by the application of limited amount of localized heat. The temperature of heated areas, as measured by approved methods, shall not exceed 600sq.c

##### 3.1.3 CUTTING

Cutting shall be effected by shearing. Cropping or sawing use of mechanically controlled gas cutting torch be permitted for mild steel only. Gas cutting of high tensile steel may also be permitted provided special care is taken to leave sufficient metal to be removed by machining, so that all meal that has been hardened by flame is removed. Gas cutting without a mechanically controlled torch may be permitted if special care is taken and done under expert hand, subject to the approval of the Engineer.

To determine the effective size of members cut by gas, 3mm shall be deducted from each cut edge. Gas cut edges, which will be subjected to substantial stress or which are to have weld metal deposited on 'them, shall be reasonably free from gouges, occasional notches or gauges not more than 4mm deep will be permitted Gouges greater than 4mm, that remain from cutting, shall be removed by girding. All re-entrant corners shall be shaped notch-free to a radius of at least 12mm. Shearing, cropping and gas cutting shall be clean, reasonably squire and free from any distortion.

##### 3.1.4 PLANNING OF EDGES

Planning of finishing of sheared or cropped edges of plates or shapes or of edges Gas-cut with a mechanically controlled torch shall not be required, unless specifically required by design and called for on the drawings, included in a stipulation for edge preparation for welding or as may be required after the inspection of the cut surface. Surface



## STANDARD TECHNICAL SPECIFICATION FOR FABRICATION OF STRUCTURAL STEEL WORK

PEDC/STD.SPEC/005  
REV 00

Page 11 of 25

HYDERABAD

cut with hand-flame shall generally be ground, unless specifically instructed otherwise by the Engineer.

### 3.1.5 CLEARNCES

The erection clearance for cheated ends of members connecting steel to steel shall preferably be not greater than 2mm at each end. The erection clearance at ends of beams without web cleats shall be not more than 3mm at each end, but where, for particular reasons, greater clearance is necessary, suitably designed clearings shall be provided.

### 3.2.0 RIVETED AND BOLTED CONSTRUCYION

#### 3.2.1 HOLES

Holes through more than one thickness of material for members, such as compound stanchions and girder flanges. Shall be drilled after the members are assembled and tightly clamped or bolted together punching may be permitted before assembly, if the thickness of the materials is not greater than the nominal diameter of river or bolts plus 3mm subject to a maximum thickness of 16mm provided that the holes are punched 3mm less in diameter than the required size and rammed after assembly to the full diameter.

Holes for rivets or black bolts shall be not more than 1.5mm or 2.0mm (depending on whether the diameter of the rivet or bolt is less or more than or equal to 25mm) Larger in diameter than the nominal diameter of the rivet or black bolt passing through them.

Holes for turned bolts shall be drilled to a diameter equal to the nominal diameter of the shank or barrel subject top a tolerance grade of HB as specified in IS:919. Parts to be connected shall be firmly held together by tacking welds or clamps and the holes drilled through all the thickness in one operation and subsequently reamed to size. Holes not drilled through all thickness in one operation shall be drilled to a smaller size and reamed out after assembly.

Holes for rivets or bolts shall not be formed by gas cutting process.

#### 3.2.2 ASSEMBLY

All parts of riveted member shall be well pinned or bolted and rigidly held together while riveting drafting to enlarge unmatching holes shall not generally be permitted. In case drafting is permitted to a slight extent during assembly it shall not distort the metal on enlarge the holes. Holes that must be enlarged to admit the rivets or bolts shall be to assembled that they are neither twisted not otherwise damaged, and shall be so prepared that the specified cambers, if any, are maintained.

Rivets shall ordinarily be hot driven, in which case their finished heads shall be approximately hemispherical in shape and shall be or uniform size throughout the work for rivets of the same size full, neatly finished and concentric with the holes. Rivets shall be heated uniformly to a temperature not exceeding the holes. Rivets shall be heated uniformly



## STANDARD TECHNICAL SPECIFICATION FOR FABRICATION OF STRUCTURAL STEEL WORK

PEDC/STD.SPEC/005  
REV 00

Page 12 of 25

HYDERABAD

to a temperature not exceeding 1065<sup>0</sup>C. They shall not be driven after their temperature has fallen below 540<sup>0</sup>C.

Rivets shall be driven by power riveters, of either compression or manually operated type, employing pneumatic, hydraulic or electric power. Hand driven rivets shall not be allowed unless in exceptional cases specially approved by the Engineer. After driving, rivets shall be tight, shall, completely fill the holes and their heads shall be in full contact with the surface. In case of countersunk rivets, the countersinking shall be fully filled by the rivets any proudness of the countersunk head being dressed off flush, if required.

Rivets member shall have all parts firmly drawn and held together before and during riveting and special care shall be taken in this respect for all single riveted connections. For multiple riveted connections, a service bolts shall be provided in every third or fourth hole.

All loose, burnt or otherwise defective rivets shall be cut out and replaced and special care shall be taken to inspect all single riveted connections. Special care shall also be taken in heating and driving long rivets the Contractor shall prove the quality of riveting by cutting some rivets chosen at random by the Engineer. No extra payment will be made to the Contractor for such cutting and replacing to the extent of ten sound rivet per five hundred done Riveting work, for any particular section or group, will be considered satisfactory when at least 90% of the corresponding cut rivets are found to be sound. If the ratio is below 75%, all the rivets in the particulars section or group shall be cut, removed and replaced and tested again at the Contractor's expense. For cases between 75% and 90% the Engineer shall have the option to instruct cutting and replacing any number of further rivets at the Contractor's cost as he deems necessary.

Bolted construction shall be permitted only in case of field connections if called for on the Drawings and is subjected to the limitation of particular connections as may be specified. In special cases, however, shop bolt connections may be allowed if directed by the Engineer.

Washers shall be tapered or otherwise suitably shaped, where necessary, to give the heads and nuts of bolts a satisfactory bearing. The threaded portion of each bolt shall project out through the nut at least one thread. In all cases the bolt shall be provided with a washer of sufficient thickness under the nut to avoid any threaded portion of the bolts being within the thickness of the parts bolted together. In addition to the normal washer one spring washer or lock-nut shall be provided for each bolt for connections subjected to vibrating forces or otherwise forces or otherwise as many by specified on the Drawings.

### 3.3.0 WELDED CONSTRUCTION

#### 3.3.1 GENERAL

Welding shall be in accordance with relevant Indian Standards and as supplemented in the Specification. Welding shall be done by experienced and good welders who have been qualified by tests in accordance with IS:817.



## STANDARD TECHNICAL SPECIFICATION FOR FABRICATION OF STRUCTURAL STEEL WORK

PEDC/STD.SPEC/005  
REV 00

Page 13 of 25

HYDERABAD

### 3.3.2 PREPARATION OF MATERIAL

Surface to be welded shall be free from loose scale, slag, rust, grease, paint and any other foreign material except that mill scale which withstands vigorous wire brushing may remain. Joint surface shall be free from fine and tears. Preparation of edges by gas-cutting shall, wherever practicable, be done by a mechanically guided torch.

### 3.3.3 ASSEMBLING

Parts to be fillet welded shall be brought in close contact as practicable and in no event shall be separated by more than 4mm. If the separation is 1.5mm or greater, the size of the fillet welds shall be increased by the amount of the separation. The fit at joints at contact surfaces which are not completely sealed by welds, shall be close enough to exclude water after painting.

Abutting parts to be butt-welded shall be carefully aligned Misalignments greater than 3mm shall be corrected and in making the correction the parts shall not be drawn into a sharper slope than two degrees ( $2^0$ )

The work shall be positioned for that welding whenever practicable.

### 3.3.4 WELDING SEQUENCE

In assembling and jointing parts of a structure of built-up members, the procedure and sequence of welding shall be as will avoid needless distortion and minimize shrinkage stresses. Where it is impossible to avoid high residual stresses in the closing welds of welds of a rigid assembly, such closing welds shall be made in compression elements.

In the fabrication of cover-plated beams and built-up members, all shop splices in each component part shall be made before such component part is welded to other parts of the member. Long girders or girder sections may be made by shop splicing not more than three sub-sections, each made in accordance with this paragraph.

When required by the Engineer, welded assemblies shall be stress relieved by heat treating in accordance with the provisions of the relevant Indian Standard or any other Standard approved by the Engineer.

### 3.5.5 WELDING TECHNIQUE

All complete penetration groove welds made by manual welding, except when produced with the aid of backing materials not more than 8mm thick with root opening not less than shall have the root of the initial layer gouged out on the back side before welding is started from that side, and shall be so welded as to secure sound metal and, complete fusion throughout the entire cross-section. Groove welds made with the use of the backing of the same material as the base metal shall have the weld metal thoroughly fused with the backing



## STANDARD TECHNICAL SPECIFICATION FOR FABRICATION OF STRUCTURAL STEEL WORK

PEDC/STD.SPEC/005  
REV 00

Page 14 of 25

HYDERABAD

material. Backing strips need not removed. If required, they may be removed by gouging or gas cutting after welding is completed, provided no injury is done to the base metal and weld metal and the weld metal surface is left flush or slightly convex with full throat thickness

Groove welds shall be terminated at the ends of a joint in a manner that will ensure their soundness. Where possible, that should be done by use of extension bars or run-off plates. Extension bars or run-off plates need not be removed upon completion of the weld unless otherwise specified elsewhere in the Contract.

To get the best and consistent quality of welding, automatic submerged arc process shall be preferred. The technique of welding employed, the appearance and quality of welds made, and the methods of correcting defective work shall all conform to relevant Indian Standards.

### 3.3.6 TEMPERATURE

No welding shall normally be done on parent material at temperature below  $(- ) 5^{\circ} \text{C}$ . However, if welding is to be undertaken at low temperature, adequate precautions as recommended in relevant Indian Standard shall be taken. When the parent material is less than 40mm thick and the temperature is between  $(- ) 5^{\circ} \text{C}$  and  $0^{\circ} \text{C}$ , the surface around the joint to a distance of 100mm or 4 times the thickness of the material, whichever is greater, shall be preheated till it is hand warm. When the parent material is more than 40mm thick, the temperature of the area mentioned above shall be in no case be less than  $20^{\circ} \text{C}$ . All requirements regarding preheating of the parent material shall be in accordance with the relevant Indian Standard.

### 3.3.7 PEENING

Where required, intermediate layers of multiple-layer welds may be peened with light blows from a power hammer, using a round-nose tool. Peening shall be done after the welds have cooled to a temperature warm to the hand. Care shall be exercised to prevent sealing or flaking of weld and base metal from over peening.

### 3.3.8 EQUIPMENT

Welding equipment shall be capable of producing proper current so that the operator produce satisfactory welds. The welding machine shall be of a type and capacity as recommended by the manufacturer of electrodes or as may be approved by the Engineer.

### 3.4.0 FINISH

Column splices and butt joint compression members deepening on contact for stress transmission shall be accurately machined and close-butted over the whole section with a clearance not exceeding 0.1 mm locally at any place. In column caps and bases, the ends of shafts together with the attached gussets, angles, channels etc, after welding/riveting together, should be accurately machined so that the parts connect butt over the entire surface of contact, Care should be taken that those connecting angles on channels are fixed with such accuracy that they are reduced in thickness by machining by more than 1.0mm.



## STANDARD TECHNICAL SPECIFICATION FOR FABRICATION OF STRUCTURAL STEEL WORK

PEDC/STD.SPEC/005  
REV 00

Page 15 of 25

HYDERABAD

### 3.5.0 SLAB BASES AND CAPS

Bases and caps fabricated out of steel slabs, except when cut from material with true surface, shall be accurately machined over the bearing surface and shall be in effective contact with the end of the stanchion. A bearing face which is to be grouted direct to a foundation need be machined if such face is true and parallel to the upper face.

### 3.6.0 LACING BARS

The ends of lacing bars shall be neat and free from burns.

### 3.7.0 SEPARATORS

Rolled section or built-up steel separated or diaphragms shall be required for all double beams except where encased in concrete, in which case, pipe separators shall be used.

### 3.8.0 BEARING PLATES

Provision shall be made for all necessary, steel bearing plates to taken up reaction of beams and columns and the required stiffeners and gussets whether or not specified in Drawings.

### 3.9.0 ARCHITECTURAL CLEARANCES

Bearing plates and stiffener connections shall not be permitted to encroach the designed architectural clearances.

### 3.10.0 SHOP COMMUNICATIONS

- a) All shop connections shall be either riveted or welded at specified on the Drawings
- b) Heads of rivets on surfaces carrying brick walls shall be flattened 10mm thick projection.
- c) Certain connections, specified to be shop connections, may be changed to field connections if desired by the Engineer for convenience of erection and Contractor will have to make the desired changes at no extra cost to the Owner.

### 3.11.0 CASTINGS

Steel castings shall be annealed

### 3.12.0 SHOP ERECTION

The steelwork shall be temporarily shop-erected complete or as directed by the Engineer so that accuracy of fit may be checked before despatch. The parts shall be shop-erected with a sufficient member of parallel drifts to bring and keep the parts in place in case of parts



**STANDARD TECHNICAL SPECIFICATION  
FOR FABRICATION OF STRUCTURAL  
STEEL WORK**

PEDC/STD.SPEC/005  
REV 00

Page 16 of 25

HYDERABAD

drilled or punched using steel jigs to make all interchangeable, the steelwork shall be shop erected in will facilitate the check of interchange ability

### 3.13.0 SHOP PAINTING

#### 3.13.1 GENERAL

Unless otherwise specified, steelwork which will be concealed by interior building finish need not be painted, steelwork to be uncared in concrete shall not be painted. Unless specifically exempted, all other steelwork shall be given one coat of shop paint, applied thoroughly and evenly to dry substances which have been cleaned, in accordance with the following paragraph, by brush, spotty, roller coating, flow-coating or dripping as may be approved by the Engineer.

After inspection and approved and before leaving the shop, all steel work specified to be painted shall be cleaned by hand-wire brushing or by other method of loose mill scale loose rust, weld slag or flux deposit, dirt and other foreign matter. Oil and grease deposits shall be removed by solvent. Steelwork specified to have no shop paint shall, after fabrication, be cleaned of oil of grease by solvent cleaners and be cleaned of dirt and other foreign material by through sweeping with a fibre brush.

#### 3.13.2 INACCESSIBLE PARTS

Surface not in contact, but inaccessible after assembly, shall receive two coats of shop paint, positively of different colours to prove application of two coats before assembly. This does not apply to the interior of sealed hollow sections.

#### 3.13.3 CONTACT SURFACES

Contact surface shall be cleaned in accordance with Sub-clause 3.13.1 before assembly.

#### 3.13.4 FINISHED SURFACES

Machine finished surface shall be protected against corrosion by a rust inhibiting coating that can be easily removed prior to erection or which has characteristics that make removal unnecessary prior to erection.

#### 3.13.5 SURFACES ADJACENT TO FIELD WELDS:

Unless otherwise provided for surfaces within 50 mm of any field weld location shall be Free of materials that would prevent proper welding or produce objectionable fumes while welding is being done.

### 3.14.0 GALVANIZING

#### 3.14.1 GENERAL



## STANDARD TECHNICAL SPECIFICATION FOR FABRICATION OF STRUCTURAL STEEL WORK

PEDC/STD.SPEC/005  
REV 00

Page 17 of 25

HYDERABAD

Structural steelwork for switchyard or other structures as may be specified in the Contract shall be not dip galvanized in accordance with the American Society for Testing and Materials Specification ASTM-A 123 or IS:2629: Recommended practice for Hot – Dip Galvanizing of Iron and Steel. Where the steel structures are required to be galvanized the field connection materials like bolts, nuts and washers shall also be galvanized.

### 3.14.2 SURFACE PREPARATION

All members to be galvanized shall be cleaned, by the process of picking of rust, loose scale, dirt, oil, grease, slag and spatter of welded areas and other foreign substances prior to galvanizing pickling shall be carried out by immersing the steel in an acid bath containing either sulphuric or hydrochloric acid at a suitable concentration and temperature. The concentration of the acid and the temperature of the bath can be varied, provided that the pickling time is adjusted accordingly.

The pickling process shall be completed by thoroughly rinsing with water, which should preferably be warm, so as to remove the residual acid.

### 3.14.3 PROCEDURE

Galvanizing shall be carried out by hot dip process in a proper and uniformly heated bath. It shall meet all the requirements when tested in accordance with IS:2633: Method for testing uniformity of coating on Zinc Coated Articles and IS:4759: Specifications for Hot – Dip Zinc coatings on structural Steel and other Allied products.

After finishing the threads of bolts, galvanizing shall be applied over the entire surface uniformly. The threads of bolts shall not be machined after galvanizing and shall not be clogged with zinc. The threads of nuts may be tapped after galvanizing but care shall be taken to use oil in the threads of nuts during erection.

The surface preparation for galvanizing and process of galvanizing itself, shall not adversely affect the mechanical properties of the materials to be galvanized where members are of such lengths as to prevent complete dipping in one operation, great care shall be taken to prevent warping.

Materials on which galvanizing has been damaged shall be acid stripped and re-galvanized unless otherwise directed, but if any member becomes damaged after having been dipped twice, it shall be rejected. Special care shall be taken not to injure the skin on galvanized surface during transport, handling and erection. Damages, if occur, shall be made good in accordance with the provision or as directed by the Engineer.

### 4.0.0 INSPECTION TESTING, ACCEPTANCE CRITERIA

#### 4.1.0 Inspection



## STANDARD TECHNICAL SPECIFICATION FOR FABRICATION OF STRUCTURAL STEEL WORK

PEDC/STD.SPEC/005  
REV 00

Page 18 of 25

HYDERABAD

Unless specified otherwise, inspection to all work shall be made by the Engineer or Engineer's representative at the place of manufacture prior to delivery. The Engineer or his representative shall have free access at all responsible times to those parts of the manufacturer's works which are concerned with the fabrication of the steel work under this contract and he shall be afforded all responsible facilities for satisfying himself that the fabrication is being done in accordance with the provisions of this specification.

The contractor shall provide free of charge, such labour, materials, electricity, fuel, water, stores, tools and paint, apparatus and instruments as may be required by the engineer to carry out inspection and/or tests in accordance with the contract.

The contractor shall guarantee compliance with the provisions of this specification.

### 4.2.0 TESTING AND ACCEPTANCE CRITERIA

#### 4.2.1 General

The contractor shall carry out sampling and testing in accordance with the relevant Indian standards and as supplemented here in for the following items at his own cost, unless otherwise specified in the contract. The contractor shall get the specimens tested in a laboratory approved by the engineer and submit to the engineer the test results in triplicate within 3 (three) days after completion of the test.

#### 4.2.2 Steel

All steel supplied by the contractor shall conform to the relevant Indian standards except otherwise mentioned in the contract, only tested quality steel having mill test reports shall be used. In case unidentified steel materials are permitted to be used by the engineer, random samples of materials will be taken from each unidentified lot of 50 MT or less of any particular section for tests to confirm to relevant Indian standards. Cost of all tests shall be borne by the contractor.

All materials shall be free from all imperfections, mill scales, slag intrusions, laminations, pittings, rusts etc. That may impair their strength, durability and appearance.

#### 4.2.3 Welding

All electrodes shall be procured from reliable manufacturers with test certificates.

The correct grade and size of electrode which has not deteriorated in storage shall be used. The inspection and testing of welding shall be performed in accordance with the provisions of the relevant Indian standards or other equivalents. For every 50 tonnes of welded fabrication, the engineer may ask for 1 (one) test-destructive or non-destructive including X-ray, ultrasonic test or similar, the cost of which shall be borne by the contractor in the event of further tests as may be desired by the engineer, the cost of such tests shall be borne by the contractor if the results are found to be unsatisfactory; and if the test shows no defect, the cost shall be borne by the owner. In cases of the test results showing deficiency,



## STANDARD TECHNICAL SPECIFICATION FOR FABRICATION OF STRUCTURAL STEEL WORK

PEDC/STD.SPEC/005  
REV 00

Page 19 of 25

HYDERABAD

the engineer shall have option to reject or instruct any remedial measures to be taken free of charge to the owner.

### 4.2.4 RIVETS, BOLTS, NUTS AND WASHERS

All rivets, bolts, nuts and washers shall be produced from M/s Guest Keen Williams Ltd, or equivalent and shall conform to the the relevant Indian Standards. If desired by the Engineer, representative samples of these materials may have to be tested in an approved laboratory and in accordance with the procedures described in relevant Indian Standards. Cost of all such testing shall have to be borne by the Contractor. In addition to testing the rivets by hammer, 2% (two percent) of the rivets done shall be cut off by chisels to ascertain the fit. Quality of material and workmanship. The removal of the cut rivets and reinstallation new rivets shall be done by the Contractor at his own cost.

### 4.2.5 SHOP PAINTING

All paints and primers shall be of standard quality and produced from approved manufactures and shall conform to the provisions of the relevant Indian Standards.

### 4.2.6 GALVANIZING

All galvanizing shall be uniform and of standard quality when tested in accordance with IS:2633: Method for testing uniformly of coating on Zinc Coated Articles and IS:4759: Specifications for Hot – Dip Zinc coatings on structural Steel and other Allied products.

### 4.3.0 TOLERANCE

The tolerance on the dimensions of individual rolled steel components shall be as specified in IS: 1852: Rolling and cutting tolerance for hot-rolled steel products. The tolerance on straightness, length etc. of various fabricated components (such as beams and girders, columns, crane gantry girder etc.) of the steel structures shall be as specified in IS 7215: Tolerance for fabrication of steel structures.

### 4.4.0 ACCEPTANCE

Should any structure or part of a structure be found not to comply with any of the provisions of this Specification, the same shall be liable to rejection. No structure or part of the structure, once rejected, shall be offered again for test, except in cases where the Engineer considers the defects rectifiable. The Engineer may, at his discretion, check the test results obtained at the Contractor's works by independent tests at an approved laboratory and should the items, so tested, be found to be unsatisfactory, the costs shall be borne by the Contractor, and if satisfactory, the costs shall be borne by the Owner.

When all tests to be performed in the Contractor's shop under the terms of this contract have been successfully carried out, the steelwork will accepted forthwith and the Engineer will issue an acceptance certificate, upon receipt of which, the



## STANDARD TECHNICAL SPECIFICATION FOR FABRICATION OF STRUCTURAL STEEL WORK

PEDC/STD.SPEC/005  
REV 00

Page 20 of 25

HYDERABAD

items will be shop painted, picked and despatched. No item to be delivered unless an acceptance certificate for the same has been issued. The satisfactory completion of these tests or the issue of the certificates shall not bind the Owner to accept the work., should it, on further tests before or after erection, be found not in compliance with the Contract.

### 4.5.0 DELIVERY OF MATERIALS

#### 4.5.1 GENERAL

The Contractor will deliver the fabricated structural steel materials to site with all necessary field connection materials in such sequence as will permit the most efficient and economical performance of the erection work. The Owner may prescribe or control the sequence of delivery of materials, at his own discretion.

#### 4.5.2 MARKING

Each separate piece of fabricated steel work shall be distinctly marked on all surface before delivery in accordance with the markings shown on approved erection drawings and shall bear such other marks as will further facilitate identification and erection.

#### 4.5.3 SHIPPING

Shipping shall be strictly in accordance with the sequence stipulated in the agreed programme. Payment may held up for items sent in advance of the sequence till they could be erected. The contractor shall include and provide for in his rates, the Freight and other charges for despatching the materials to avoid loss or damage during transport by rail, road or water. All packing shall allow for easy removal and checking at site. Special precautions shall be taken against rusting, corrosion, breakage or damage otherwise of the materials. All parts shall be adequately braced to prevent damage in transit.

Each bundle, bale or package delivered under this contract shall be marked on as many sides as possible and distinct marking (all previous irrelevant markings being carefully obliterated) shall show the following:-

- a) Name and address of the consignee
- b) Name and address of the consignor
- c) Gross weight of the package in tonnes and its dimensions
- d) Identification marks and / or number of the package
- e) Custom registration number, if required

All markings shall be carried out with such materials as would ensure quick drying and indelibility.



**STANDARD TECHNICAL SPECIFICATION  
FOR FABRICATION OF STRUCTURAL  
STEEL WORK**

PEDC/STD.SPEC/005  
REV 00

Page 21 of 25

HYDERABAD

Each component or part or piece of material when shipped, shall be indelibly marked and/or tagged with reference to assembly drawings and corresponding piece numbers.

Each packing case shall contain in duplicate in English a packing list pasted on to inside of the cover in water-proof envelope, quoting especially:-

- a) Name of the Contractor
- b) Number and date of the Contract
- c) Name of the office placing the contact
- d) Nomenclature of stores
- e) A schedule of parts or pieces, giving the parts or piece number with reference to assembly drawing and the quantity of each

The shipping dimensions of each package shall not exceed the maximum dimensions permissible for transport over the Indian Railways/ Roads.

After delivery of the materials at site, all packing materials shall automatically become the property of the Owner without any extra payment.

Notwithstanding anything stated hereinbefore, any loss or damage resulting from inadequate packing shall be made good by the Contractor at no additional cost to the Owner. When facilities exist, all shipments shall be covered by approved Insurance Policy for transits at the cost of the Contractor.

The contractor shall ship the complete materials or part on board a vessel belonging to an agency approved by the Owner or on rail and / or road transport

As directed. The Contractor shall take all reasonable steps to ensure correct appraisal of freight rates, weights and volumes and in no case will the Owner be liable to pay any warehouse, wharf age, demurrage and other charges.

If, however, the Owner has to make payment of any of above mentioned charges, the amount paid will be deducted from the progressive bills of the Contractor.

Necessary advise regarding the shipment with relevant details shall reach the Engineer at least a week in advance.

**5.0.0 WITH TENDER**

The following information are required to be submitted with the Tender.

- a) Progress Schedule.



**STANDARD TECHNICAL SPECIFICATION  
FOR FABRICATION OF STRUCTURAL  
STEEL WORK**

PEDC/STD.SPEC/005  
REV 00

Page 22 of 25

HYDERABAD

The Contractor shall quote in his tender a detailed schedule of progress of work and total time of completion, itemising the time required for each of the following aspects of work.

- 1) Preparation and approval of shop drawings
- 2) Procurement of materials
- 3) Fabrication and shipping of all anchor bolts
- 4) Fabrication and shipping of main steel work
- 5) Fabrication and shipping of main steel work for bunkers Tanks and / or silos as applicable.
- 6) Fabrication and shipping of all other remaining steelwork including miscellaneous steelwork.
- 7) Final date of completion of all shipments

Time required for completion being one of the main criteria for selecting the successful bidder, it is desired that the bidder quotes the minimum time required by him for completing the work

- b) Shop

Location of the Tender's fabrication workshop giving details of equipment, manpower, the total capacity that will be available exclusively for this contract shall be submitted.

- c) **MATCHING STEEL**

A rough indication for the quantities and details of matching steel section required to start the work shall be furnished.

- d) **TRANSPORT OF STEEL**

In case the tendered is to draw steel materials from the Owner's stores at site as per terms and conditions of the Contract, the mode of transport proposed by the Tender shall be stated.

**5.1.0 AFTER AWARD**

After award of the Contract the successful Tender is to submit the following:-

- a) Complete fabrication drawings, material lists, cutting lists, rivet and bolt lists, field welding schedules based on the design drawings furnished to him in accordance with the approved schedule.



## STANDARD TECHNICAL SPECIFICATION FOR FABRICATION OF STRUCTURAL STEEL WORK

PEDC/STD.SPEC/005  
REV 00

Page 23 of 25

HYDERABAD

- b) List of phase wise requirement of matching steel section in six (6) copies in accordance with the approved schedule shall be submitted within 2(two) weeks after the award of the contract, and/or receipt of the design drawings
- c) Monthly progress Report with necessary, photographs in six (5) copies to reach the Engineer on or before the 7<sup>th</sup> day of each month, giving the up to date status of preparation of detailed shop drawings bill of materials. Procurement of materials, actual fabrication done, shipping and all other relevant information.
- d) Detailed monthly material reconciliation statements relevant to the work done and reported in the progress report, giving the stock at the hand of raw steel, work in progress, finished materials and scrap.
- e) Results of any test and when conducted and as required by the Engineer.
- f) Manufacturer's mill test report in respect of steel materials, rivets, bolts, nuts and electrodes as may be applicable.

### 6.0.0 ADDITIONAL CODES AND STANDARD

IS:823	Code of Procedure for manual Metal ARC welding of Mild Steel
IS:1024	Code of practice for the use of welding in Bridges and Structures subjected to Dynamic loading
IS:1365	Slotted counter sunk Head and slotted Raised counter sunk Head Screw (dia 1.6 to 20mm)
IS:1447	Code of practice for Finishing of Ferrous Metals in Buildings Painting and Allied finisher
IS:2016	Plain Washers
IS:3664	Code of practice for Ultrasonic Testing by Pulse Echo Method
IS:5334	Code of practice for Magnetic particle Flow detection of Welds.
IS:7318	Approval Test for Welds when welding procedure Approval is not Required
IS:7318	Fusion welding of Steel (part I)



**STANDARD TECHNICAL SPECIFICATION  
FOR FABRICATION OF STRUCTURAL  
STEEL WORK**

PEDC/STD.SPEC/005  
REV 00

Page 24 of 25

HYDERABAD

**METHOD AND BASIS FOR PAYMENT FOR FABRICATION  
& ERECTION OF STRUCTURAL STEEL.**

- 1) Payment for structural steel works shall be made on the basis of admissible weight in tons (determined as described in clause between of structure accepted by the Engineer-in-charge. The rate shall include supplying, fabrication, erecting in position ( at al level & location), testing/examining (excluding radiography only) of bolted and/or welded structural steel works of all types(including all built up/compound sections made out of rolled sections and/or plates) including all handling, transporting, storing, straightening if required, cutting, edge preparation, preheating, bolting and welding),of joints (including sealing the joints of ox sections with continuous welding), finishing edges by grinding, fixing in line & level with temporary staging & bracing and removal of the same erection, grouting with ordinary/non-shrink grout as specified, including preparation of fabrication & erection drawings, erection schedule and getting them reviewed, preparing the surfaces for painting, surface cleaning, wire brushing, removal or mill scale, dust, rust, oil or grease and applying one coat of red oxide zinc chromate primer after fabrication etc. all complete as specified.
- 2) The weight for payment shall be determined from the fabrication drawings and respective Bill of materials prepared by the contractor wherever applicable. In case sections used are different from IS sections, then Manufactures Hand Book shall be adopted No allowance in weight shall be made for rolling tolerances.
- 3) Welds, bolts, nuts, washers, shims, pack plates, wedges and grout shall not be measured. The quoted rate shall be deemed to include the same.

IS:816: Code of practice for use of metal are welding for general construction in mild steel

IS:817 : Code of practice for training and testing metal are welders.

IS:818: Code of practice for safety, and health requirements in electric and gas welding and cutting operations.

IS:822: Code of practice for inspection of welds.

IS:9595: Recommendations for metal are welding of carbon and carbon manganese steel:

IS:919: Recommendations for limits and fits for Engineer.

IS:961:Structural Steel (High tensile)

IS:1148: Rivets bars for structural purposes.

IS:1149:High tensile rivets bars for structural purposes

IS:1161: Steel Tubes for structural purposes



**STANDARD TECHNICAL SPECIFICATION  
FOR FABRICATION OF STRUCTURAL  
STEEL WORK**

PEDC/STD.SPEC/005  
REV 00

Page 25 of 25

HYDERABAD

IS:1200: Method of measurement of steelwork and ironwork (Part-B)

IS:1239: Mild Steel Tubes

IS:1363: Black hexagon bolts, nuts and lock nuts (dia. 6 to 30mm) and black hexagon screws (dia 6 to 24mm)

IS:1367: Technical supply conditions for threaded fasteners

IS:1442: Covered electrodes for the metal arc welding of high tensile structural steel.

.



HYDERABAD

**STANDARD TECHNICAL  
SPECIFICATION FOR ERECTION OF  
STRUCTURAL STEEL WORK**

PEDC/STD.SPEC/006  
REV 00

Page 1 of 15

**ERECTION OF STRUCTURAL STEEL WORK**

REV. NO.	PRAPARED	APPROVED	DATE

**COPYRIGHT AND CONFIDENTIAL**

The information on this document is the property of BHARAT HEVY ELECTRICAL LTD.It must not be used directly or indirectly in any way detrimental to the interest of the Company.



## STANDARD TECHNICAL SPECIFICATION FOR ERECTION OF STRUCTURAL STEEL WORK

PEDC/STD.SPEC/006  
REV 00

Page 2 of 15

HYDERABAD

### 1.0.0 SCOPE

This specification covers the erection of structural steelwork including receiving and taking delivery of fabricated structural steel materials arriving at Site, and/or from Owner's Site stores and store Yard. Installing the same in position, painting and grouting the stanchion bases all-complete as per drawings, this Specification and provision of the Contract.

### 2.0.0 GENERAL

#### 2.1.0 Work to be provided for by the Contractor

The work to be provided for by the Contractor, unless otherwise specified in the Contract, shall include but not be limited to the following:-

- a) The Contractor shall provide all construction and transport equipment, tools, tackle, consumables, materials, labour and supervision required for the erection of the structural steelwork.
- b) Receiving, unloading, checking and moving to storage yard at site including prompt attendance to all insurance matter as necessary, for all fabricated steel materials arriving at site. The Contractor shall pay all demurrage and/ at Wharf age charges etc. on account of default on his part.
- c) Transportation of all fabricated structural steel materials Site storage yard, handling, rigging, assembling, riveting, bolting, welding and satisfactory installation of all fabricated structural steel materials in proper location according to approved erection drawings and/or as directed by the Engineer. If necessary suitable temporary approach roads transportation of fabricated steel structures.
- d) Checking centre lines, levels of all foundation blocks including checking line, level, position and plumb of all bolts and pockets. Any defect observed in the foundation shall be brought to the notice of the Engineer. The Contractor shall fully satisfy himself regarding the correctness of the foundations before installing the fabricated steel structures on the foundation blocks.
- e) Aligning, plumbing, levelling, riveting, bolting, welding and securely fixing the fabricated steel structures in accordance with the Drawings or as directed by the Engineer.
- f) Painting of erected steel structures if required by the Contract.
- g) All minor modifications of the fabrications of the fabricated steel structures as directed by the Engineer including but not limited to the following:-
  - 1) Removal of bends, kinks, twists etc. for parts damaged during transport and Handling.
  - 2) Cutting, chipping, filling, grinding etc. if required for preparation and Finishing of site connections.
  - 3) Reaming of holes for use of higher size rivet or built if required.
  - 4) Welding of connections in place of riveting or bolting for which holes are



## STANDARD TECHNICAL SPECIFICATION FOR ERECTION OF STRUCTURAL STEEL WORK

PEDC/STD.SPEC/006  
REV 00

Page 3 of 15

HYDERABAD

Either not drilled at all or wrongly drilled during fabrication. Welding in place of riveting or bolting will be permitted only the discretion of the Engineer.

- 5) Refabrication of parts damaged beyond repair during transport and Handling of Refabrication of parts, which are incorrectly fabricated.
- 6) Fabrication of parts omitted during fabrication by error, or subsequently Found necessary.
- 7) Drilling of holes which are either not drilled at all or are drilled in incorrect location during fabrication.
- 8) Carry out tests in accordance with this Specification if directed.

### 2.2.0 WORK BY OTHERS

No work under this specification will be provided for by any agency other than the contractor unless specifically mentioned elsewhere in the contract

### 2.3.0. CODES AND STANDARDS:

All work this specification unless specified otherwise, conform to the latest revisions and/or replacements of the following or any other Indian Standard Specification and codes of practice of equivalent:-

IS – 800: Code of practice for use of structural steel in general building construction.

IS - 456: Code of practice for plain or reinforced concrete.

### 2.4.0 CONFORMITY WITH DESIGNS

The Contractor will erect the entire fabricated steel fabricated steel structure, align the all members, complete all field connections and group the foundations all as per the provisions of this specification and sequence and the design criteria laid down by the Engineer. All work shall conform to the provisions of the relevant Indian Standard Specifications and/ or the instructions the engineer. The testing and acceptance of the erected structures shall be in accordance. The testing and acceptance of the erected structures shall be in accordance with the provisions of this Specification and / or the Instruction of the Engineer.

### 2.5.0 MATERIAL

#### 2.5.1 GENERAL

All fabricated steel structures and connection materials shall be supplied by the Contractor for fabrication work through the Owner. The Contractor for erection work will take delivery of all the materials from the Owner's Stores or storage yard at site. The Contractor may also have to take delivery directly from railway wagons or trucks at Site, in which case he shall



HYDERABAD

## STANDARD TECHNICAL SPECIFICATION FOR ERECTION OF STRUCTURAL STEEL WORK

PEDC/STD.SPEC/006  
REV 00

Page 4 of 15

have to unload the materials and perform all formalities like checking of materials and attend to insurance matters in accordance with Sub-Clause 2.1.0 and as specified hereinbefore.

While taking delivery, the Contractor will check the quantity, quality and the sizes of the materials and verify the adequacy of the same in accordance with the Drawings and Specifications. In case the Contractor finds any materials inadequate, he shall inform the Engineer immediately prior to taking delivery of the same. No claim whatsoever, in respect of bad quality, shortage or difference in size will be entertained once the delivery is taken and the Contractor shall make good any such deficiency, if detected later, either by repair or with fresh material as be directed, by the Engineer at the Contractor's Own cost.

Excepting all field connection materials like rivets, bolts, nuts, washers and electrodes, which will be supplied by the fabrication Contractor to the extent of 10% in excess of the estimated requirements as per Drawings, all other consumables like Oxygen and acetylene gas, paints, fuels, lubricants, oil, grease, cement, sand, aggregates and any other materials that may be required for the execution of the works in accordance with the contract will be supplied by the contractor for erection work and will be deemed to have been including in this rates.

### 2.5.2 MATERIALS TO CONFORM TO INDIAN STANDARDS

All materials required to be supplied by the Contractor under this Contract shall conform to the relevant Indian Standard Specifications.

### 2.6.0 STORAGE OF MATERIALS

#### 2.6.1 GENERAL

All material shall be so stored as to prevent deterioration and to ensure the preservation of their quality and fitness for use in the works. Any material which has been deteriorated or damaged beyond repairs and has become unfit for use be removed immediately from the site, failing which, the Engineer shall be at liberty to get the materials removed by agency and the cost incurred thereof shall be realised from the Contractor's dues.

#### 2.6.2 YARD

The Contractor will have to be establishing a suitable yard in the approved location at site for storing the fabricated steel structures and other materials will be delivered to him by the Owner recording to the Contract. The yard shall have proper facilities like, drainage, lighting, suitable access for large cranes, trailers and other heavy equipment and shall be of sufficiently large area to permit systematic storage of the fabricated steel structures without overcrowding and with suitable access for cranes, trailers and other equipment for use in erection work in proper sequence in accordance with the approved programme of work.

The Tender should visit the site prior to submission of his Tender to acquaint himself with the availability of land and the development necessary by way of filling, drainage, access



# STANDARD TECHNICAL SPECIFICATION FOR ERECTION OF STRUCTURAL STEEL WORK

PEDC/STD.SPEC/006  
REV 00

Page 5 of 15

HYDERABAD

roads, fences, sheds etc. all of which shall be carried out by the Contractor at his own cost as directed by the Engineer.

## 2.6.3 COVERED STORE

All field connection materials, paints, cement etc. shall be stored on well designed racks and platforms off the ground in the ground in a property covered store building to be built at the cost of the Contractor.

## 2.2.0 QUALITY CONTROL

The Contractor shall establish and maintain quality control procedures for different items of work and materials as may be directed by the Engineer to assure compliance with the provisions of the Contract and shall submit the record of the same to the Engineer. The quality control operation shall include but not be limited to the following items of work:-

- 1) Erection: Lines, levels, grades, plumbs, joint characteristics including Tightness of bolts.
- 2) Grouting: Cleaning and roughness of foundation, quality of materials used for grouting, admixtures, consistency and strength of grout.
- 3) Painting: Preparation of surface for painting, quality of primers and paints, thinners, application and uniformity of coats.

## 2.2.0 TAKING DELIVERY

The erection Contractor shall take delivery of fabricated structural steel and necessary connection materials supplied by the Fabrication Contractor from railhead, trucks and/or the Owner's stores at site as may be necessary and as directed by the Engineer. He shall check, unload; transport the materials to his stores for proper storing at his own cost. The erection Contractor shall submit claims to insurance or other authorities and pursue the same in case of loss or damaged during transit and handling and all loss there of shall be borne by him.

The erection contractor shall also take all precautions against damage of the materials in his custody after taking delivery and till the same are erected in place and accepted. The Contractor shall salvage, collect and deliver all the packing materials to the Owner free of charge.

## 3.0.0 WORKMANSHIP

### 3.1.0 ERECTION

#### 3.1.1 PLANT AND EQUIPMENT

The suitability and adequacy of all erection tools and equipment proposed to used shall be efficient, dependable, in good working condition and shall have the approval of Engineer.

#### 3.1.2 METHOD AND SEQUENCE OF ERECTION



## STANDARD TECHNICAL SPECIFICATION FOR ERECTION OF STRUCTURAL STEEL WORK

PEDC/STD.SPEC/006  
REV 00

Page 6 of 15

HYDERABAD

The method and sequence of erection shall have the prior approval of the Engineer. The Erection shall arrange for most economical method and sequence available to him consistent with the Drawings and Specifications and such information as may be furnished to him prior to the execution of the contract.

### 3.1.3 TEMPORARY BRACING

Unless adequate bracing is included as a part of the permanent framing, the erector during erection shall install, free of cost to the owner, temporary guys and bracings

Where needed to secure the framing against loads such as wind or seismic forces comparable in intensity to that for which the structure has been designed, acting upon exposed framing as well loads due to erection equipment and erection operations.

If additional temporary guys are required to resist or seismic forces acting upon components of the finished structure installed by others during the course of the erection of the steel framing, arrangement for their installation by the erector shall be made free of cost to the owner.

The responsibility of the contractor in respect of temporary bracings and guys shall cease when the structural steel is once located, plumbed, levelled, aligned and grouted within the tolerances permitted under the specification and guyed and braced to the satisfaction of the Engineer.

The temporary guys, braces, false work and cribbing shall not be the property of the Owner and they may be removed immediately upon completion of the steel erection unless other agreed arrangements are made. The Owner shall remove and return the same in good condition to the Contractor without any charge if they have been left in place under such other agreed arrangements.

### 3.1.4 TEMPORARY FLOORS FOR BUILDINGS

It shall be the responsibility of the Contractor to provide free of cost planking and to cover such floors during the work in progress as may be required by any Act of parliament and/or by laws of state, Municipal or other local authorities.

### 3.1.5 SETTING OUT

Positioning and levelling of all steelwork, plumbing of stanchions and placing of every part of the structure with accuracy shall be in accordance with the approved Drawings and to the satisfaction of the Engineer. Concrete foundations, where required, shall be made by other agencies. The Contractor shall check the positions and levels of the anchor bolts, etc. before concreting and get them properly secured against disturbance during pouring operations. He shall remain responsible for correct positioning. For heavy columns, etc. the Contractor shall set proper screed bars if desired by the Engineer, to maintain proper level. No extra payment shall be made for this. Each tire of column shall be plumbed and maintained in a true vertical position subject to the limits of tolerance allowable under this Specification.

No permanent field connections by riveting bolting or welding shall be carried out until proper alignment and plumbing has been attained.



HYDERABAD

## STANDARD TECHNICAL SPECIFICATION FOR ERECTION OF STRUCTURAL STEEL WORK

PEDC/STD.SPEC/006  
REV 00

Page 7 of 15

### 3.1.6 Filed riveting

All riveting shall be heated and driven with pneumatic tools. Hand passing or 'throwing' of rivets are desirable. Any other method of conveying hot rivets from the furnace to the driving point must be approved by the engineer. No cold rivets shall be driven. All other requirements of riveting including quality and acceptance criteria shall be in accordance with the relevant portions of the Specification for Fabrication of Structural Steel work of the project.

### 3.1.7 Field bolting

All relevant portions in respect of bolted construction of the Specification for Fabrication of structural Steelwork applicable the Project shall also be applicable for filed bolting in addition to the following: -

Bolts shall be inserted in such a way so that they may remain in position under gravity even before fixing the nut. Bolted parts shall fit solidly together when assembled and shall not be separated by gaskets or any other interposed compressible materials. When assembled, all joint surfaces, including those adjacent to the washers shall be free of scale except tight mill scale. They shall be free of dirt, loose scales, burns, and other defects that would prevent solid seating of the parts. Contact surfaces within friction-type joints shall be free of oil, paint, lacquer, or galvanizing.

All high tensile bolts shall be tightened to provide, when all fasteners in the joint are tight, the required minimum bolt tension by any of the following methods.

#### a) Turn-of-nut-method

When the turn-of-nut method is used to provide the bolt tension, there shall first be enough bolts brought to a 'snug tight' condition to ensure that the parts of the joint are brought into good contact with each other. 'Snug tight' is defined as the tightness attained by a few impacts of an impact wrench or the full effort of man using an ordinary spud wrench. Following this initial operation, bolts shall be placed in any remaining holes in the applicable amount of nut rotation specified in table-1 with tightening progressing systematically from the most rigid part of the joint to its free edges. During this operation there shall be no rotation of part not turned by the wrench.

**TABLE-1**

Bolts length not	Bolts length	Remarks
Exceeding 8 dia. Or 200mm ½ turn	Exceeding 8 dia. or 200mm 2/3 turn	Nut rotation is relative To bolt regardless of The



HYDERABAD

## STANDARD TECHNICAL SPECIFICATION FOR ERECTION OF STRUCTURAL STEEL WORK

PEDC/STD.SPEC/006  
REV 00

Page 8 of 15

Element (nut or bolt) being turned. Tolerance on rotation -  $30^0$  over or under.

Bolts may be installed without hardened washers when tightening is done by the Turn- of – nut method. However, normal washers shall be used.

Bolts tightened by the turn- of – nut method may have the outer face of the nut Match-marked with the protruding bolt point before final tightening, thus affording the inspector visual means of noting the actual rotation such marks can be made by the wrench operator by suitable means after the bolts have been brought up snug tight.

### b) Torque wrench tightening

When torque wrenches are used to produce the bolt tensions, the bolts shall be tightened to the torques specified in TABLE-II. Nuts shall be in tightening motion when torque wrenches to install several bolts in a single joints, the wrench shall be returned to touch up bolts previously tightened, which may have been loosened by the tightening of subsequent bolts, until all are tightened to the required tension.

**TABLE-II**

Nominal Bolt Diameter (mm)	Torque to be applied (kg's) for bolts Class 8.8 of IS: 1367
20	59.94
22	81.63
24	103.73

In either of the above two methods, if required, for bolt entering and wrench operation clearances, tightening may be done by turning the bolt while the nut is prevented from rotating.

Impact wrenches if used shall be of adequate capacity and sufficiently supplied with air to perform the required tightening of each bolt in approximately ten seconds.

Holes for turned bolts to be inserted in the field shall be reamed in the field. All drilling and reaming for turned bolts shall be done only after the parts to be connected are assembled. Tolerances applicable in the fit of the bolts shall be in accordance with relevant Indian Standard Specifications. All other requirements regarding assembly and bolt tightening shall be in accordance with this clause.

### 3.1.8 FIELD WELDING

All field assembly and welding shall be carried out in accordance with the requirements of the specification for fabrication work applicable to the project, excepting such provisions herein which manifestly apply to shop conditions only. Where the fabrication structural steel



**STANDARD TECHNICAL  
SPECIFICATION FOR ERECTION OF  
STRUCTURAL STEEL WORK**

PEDC/STD.SPEC/006  
REV 00

Page 9 of 15

HYDERABAD

members have been delivered paints, the paint shall be removed before field welding for a distance of at least 50 mm on either side of joints.

### 3.1.9 HOLES, CUTTING AND FITTING

No cutting of sections, flanges, webs, cleats, rivets, bolts, welds etc. shall be done unless specifically approved and/or instructed by the Engineer.

The erector shall not cut, drill or otherwise alter the work of other trades, or his own work to accommodate other trades, unless such work is clearly specified in the Contractor or directed by the Engineer. Wherever such work is specified the Contractor shall obtain complete information as to size, location and number of alterations prior to carrying out any work. The Contractor shall not be entitled for any payment on account of any such work.

### 3.2.0 DRIFTING

Correction of minor misfits and reasonable amount of reaming and cutting of excess stock from rivets will be considered as permissible. For this, light drifting may be used to draw holes together and drills shall be used to enlarge holes as necessary to make connection. Reaming, that weakens the member or makes it impossible to fill the holes property or to adjust accurately after reaming, shall not be allowed

Any error in shop which prevents the prevents the proper assembling and fitting of parts by moderate use of drift pins and reamers shall immediately be called to the attention of the Engineer and approval of the method of correction obtained. The use of gas cutting torches at erection site is prohibited.

### 3.2.0 GROUTING OF STANCHION BASES AND BEARINGS OF BEAMS AND GRIDERS ON STONE, BRICKS OR CONCRETE (PLAIN OR REINFORCE)

Grouting shall be carried out with Ordinary Cement grout as described bellow:-  
The mix shall be one (1) part cement and one (1) part sand just enough water to Make it workable. The positions to be grouted shall be cleaned thoroughly with Compressed air jet and placed under expect supervision, taking care to avoid air-Looks. Edges shall be finished properly. If the thickness of grout is 25 mm or More, two (2) parts of 6 mm down graded stone chips may be added to the above Noted cement-sand grout mix, if required, by the Engineer or shown on the Drawings.

No grouting shall be carried out until a sufficient number of bottom lengths of Stanchions have been properly lined, levelled and plumbed and sufficient floor Beams are tied in position.

Whatever method of grouting is employed, the operation shall not be carried out until the steelwork has been finally levelled and plumbed, the stanchion bases being supported meanwhile by steel wedges, and immediately before grouting, the space under steel shall thoroughly cleaned.



## STANDARD TECHNICAL SPECIFICATION FOR ERECTION OF STRUCTURAL STEEL WORK

PEDC/STD.SPEC/006  
REV 00

Page 10 of 15

HYDERABAD

If required by the Engineer, certain admixtures like aluminium powder, “ironies” or equipment, may be required to the grout. The Contractor will, when so directed by the Engineer, take delivery of the material from the Owner’s site stores and use it in the grout in proportions to be decided by the Engineer and carry out the allowance of 5% (five percent) for wastage shall be allowed over the above theoretical requirement of the admixtures. Cost of any wastage beyond the above limits shall be paid for by the Contractor or will be realised from his dues at the rates prescribed by the owner.

### 3.3.0 PAINTING AFTER ERECTION

Field painting, if required to be done by the Contract, shall only be done after the structure is erected, levelled, plumbed, aligned and grouted in its final position, tested and accepted by the Engineer. However, touch up painting, making good any damaged shop painting and completing any unfinished portion of the shop coat shall be carried out by the erection Contractor free of cost to the Owner. The materials and specification for such painting in the field shall be in accordance with the requirements of the specification for fabrication of structural Steel work applicable for the project.

Painting shall not be done in frosty or foggy, weather or humidity is such as to cause condensation on the surfaces to be painted. Before painting of steel, which is delivered unpainted, is commenced, all surfaces to be painted shall be dried and thoroughly cleaned from all loose scale and rust.

All field rivets, bolts, welds and abrasions to the shop coat shall be spot painted with the same paint used for the shop coat. Where specified, surfaces which will be in contact after site assembling shall receive a coat of paint (in addition to the shop coat, if any) and shall be brought together while the paint is still wet.

Surface which will be inaccessible after field assembly shall receive the full specified protective treatment before assembly. Bolts and fabrication steel members which are galvanized or otherwise treated and steel members to be encased in concrete shall not be painted.

The specification for paint and workmanship shall be in accordance with the requirements of the specification for fabrication for fabrication of structural of structural steelwork applicable to the project. The number of coats and the shades to be used shall be as specified or as directed by the Engineer.

### 3.4.0 FINAL CLEANING UP

Upon completion of erection and before final acceptance of the work by the Engineer, the Contractor shall remove free of cost all false work. Rubbish and all Temporary works resulting in connection with the performance of his work.

### 4.0.0 TESTING AND ACCEPTANCE CRITERIA

#### 4.1.0 GENERAL



HYDERABAD

## STANDARD TECHNICAL SPECIFICATION FOR ERECTION OF STRUCTURAL STEEL WORK

PEDC/STD.SPEC/006  
REV 00

Page 11 of 15

Loading tests shall be carried out on erected structures, if required by the Engineer, to check adequacy of fabrication and/or erection. Any structure on a part thereof found to be unsuitable for acceptance as a result of the test shall have to be dismantled and replaced with suitable member as per the Contract of either fabrication or erection of steelwork whoever is responsible for it and no payment towards the cost of the dismantled portion and any connected work shall be made to the Contractor, unless it is proved that the deficiency is due to reasons beyond the Contractor's scope. On the basis of the tests, the Engineer will decide whether the fabricator or the erector is responsible for the unacceptable member or structure and his decision will be final. In case it is established that the unacceptability of the member or structure is due to design deficiency, the cost of replacement and/or modifications will borne by the Owner. In course of dismantling, if any damage is done to any other parts of the Contractor responsible, to the satisfaction of the Engineer, The cost of the tests specified hereinafter shall be borne by the Owner. Any extra claim due to loss of time, idle labour, etc. arising out of these testing operations shall not be entertained, however, only reasonable and appropriate time extensions will be allowed.

The structure or structural member under consideration shall be loaded with its actual dead as long a time as possible before testing and the tests shall be conducted as indicated in the following. Sub-clauses 4.1.1,4.1.2 and 4.1.3. The method of testing and application of loading shall be as approved by the Engineer.

### 4.1.1 STIFFNESS TEST

In this test, the structure or member shall be subjected, in addition to its actual dead load, to a test load equal to 1.5 times the specified superimposed load, and this loading shall be maintained for 24 hours. The maximum deflection attained during the test shall be within the permissible limits. If after removal of the tests load, the member or structure dose not show are recovery of at least 80 % of the maximum strain or deflection shown during 24 hours under to have load, the test shall be repeated. The structure or member shall be considered to have sufficient stiffness, provided that the recovery, after this second test not less than 90% of the maximum increase in stain or deflection recorded during the second test.

### 4.1.2 STRENGTH TEST

The structure or structural member under consideration shall be subjected, in addition to its actual dead load, to a test load equal to the sum of the dead load and twice the specified Superimposed load, and shall be maintained for 24 hours.

In the case of wind load, a load corresponding to twice the specified wind load Shall be applied and maintained for 24 hours, either with or without the vertical Test load for more severe condition in the member under consideration or the structure as a whole. Complete tests under both conditions may be necessary to verify the strength of the structure. The structure shall be deemed to have adequate strength if, during the test, no part falls and if on removal of the test load, the structure shows a recovery of at least 20% of the maximum deflection or strain recorded during the 24 hours under load.



**STANDARD TECHNICAL  
SPECIFICATION FOR ERECTION OF  
STRUCTURAL STEEL WORK**

PEDC/STD.SPEC/006  
REV 00

Page 12 of 15

HYDERABAD

#### 4.1.3 STRUCTURE OF SAME DESIGN

Where several structures are built to the same design and it is considered unnecessary to test all of them, one structure, as a prototype, shall be fully tested, as described in previous Sub-clauses, but in addition, during the first application of the test load, particular note shall be taken of the strain or deflection when the test load 1,5 times the specified superimposed load has been maintained for 24 hours. This information is required as basis of comparison in any check test carried out on sample of structure.

When a structure of the same type is selected type is selected for a check test, it Shall be subjected, in addition to its actual dead load, to a superimposed test load, Equal to 1.5 time the specified live load, to a superimposed test load, equal to 1.5 Time the specified live load. In a manner and to an extent prescribed by the Engineer. This load shall be maintained for 24 hours, during which time, the Maximum deflection shall be recorded. The check test shall be considered Satisfactory, provided that the maximum strain or deflection should be recorded.

The check test shall be considered satisfactory, provided that the maximum strain or deflection recorded at similar load in test on the prototype. or

#### 4.1.4 REPAIR FOR SUBSEQUENT TEST AND USE AFTER STRENGTH TESTS

An actual structure, which has passed the “Strength Test” as specified in Sub-Clause 4.1.2 herein before and is subsequently to be erected for use, shall be Considered satisfactory for use after it has been strengthened by replacing any Distorted members and has subsequently satisfied the ‘Stiffness Test’ as specified In Sub-clause 4.1.1 hereinbefore.

#### 4.2.0 TOLERANCES

Some variation is to be expected in the finished dimensions of structural steel Frames. Unless otherwise specified, such variations are deemed to be within the Limits of good practice when they are not in excess of the cumulative effect of Detailed erection clearances, fabricating tolerances for the finished parts and the Rolling tolerance for the profile dimensions permitted under the Specifications for fabrications of structural steel work applicable to this project and as specified Below:

1 For Building Containing Cranes

<b>Component</b>	<b>Description</b>	<b>Variation Allowed</b>
<b>1.</b>	<b>2.</b>	<b>3.</b>
Main column	a) Shifting of column axis at foundation Level with respect to building line i) In longitudinal direction	i) $\pm 3.0$ mm



**STANDARD TECHNICAL  
SPECIFICATION FOR ERECTION OF  
STRUCTURAL STEEL WORK**

PEDC/STD.SPEC/006  
REV 00

Page 13 of 15

HYDERABAD

	ii) In lateral direction	ii) $\pm 3.0$ mm	
	b) Deviation of both major or column axis From vertical between foundation and Other member connection levels:		
	i) For a column up to and including IOM height true vertical	i) $\pm 3.5$ mm from	
	ii) For a column greater than IOM but less than 40M height	ii) $\pm 3.5$ mm from vertical for any 10M length measured between connection levels, but not more than $\pm 7.0$ mm per 3.0mm length	
	c) For adjacent pairs of columns across the width of the building prior to placing shown on drawings	$\pm 9.0$ mm on true span	
	d) For any individual column deviation of Any bearing from levels shown on drawings	$\pm 3.0$ mm	
	e) For adjacent pairs of column either across The width of building or longitudinally level difference allowed between bearing or seating Level supposed to be at the same level	3 mm.	
Trusses	a) Deviation at centre of span of upper chord Member from vertical plane running through Center of bottom chord.	1/1500 of the span or not greater than 10mm Whichever is the least.	
Trusses	b) Lateral displacement of top chord At centre of span from vertical plane running through centre of support.	1/250 of depth of truss or 20mm which Ever is the least	
Crane Girders& Tracks	a) Difference in levels of crane rail measured between adjacent columns	2.0 mm	
	b) Deviation to crane rail gauge	$\pm 3.0$ mm	
	c)Relative shifting of ends of adjacent Crane rail in plan and elevation after thermit welding	1.0mm	
	d) Deviation to crane rail axis from centre line of web	$\pm 3.5$ mm	
Setting of Expansion Gaps	At the time of setting of the expansion gaps, due regard shall be taken of the ambient temperature above or Below 30 <sup>0</sup> C. The coefficient of expansion or contraction shall be as 0.000012 per <sup>0</sup> C per unit length.		taken
	iv) For Building without Cranes The maximum tolerances for line and level of the steel works shall be $\pm 3.0$ mm on Any part of the structure. The structure shall not be out plumb more than 3.5mm On each 10M section of height and not more than 7.0 mm 30 M section.		



## STANDARD TECHNICAL SPECIFICATION FOR ERECTION OF STRUCTURAL STEEL WORK

PEDC/STD.SPEC/006  
REV 00

Page 14 of 15

HYDERABAD

These tolerances shall apply to all parts of the structure unless the drawings issued for erection purposes state otherwise.

### 4.3.0 ACCEPTANCE

Structures and members which have passed the tests and conform to all requirements specified in the foregoing sub-clause 4.1, 4.1.1, 4.1.2, 4.3.1 and 4.1.4 and other applicable provisions of this Specification and are within the limits of tolerances specified in Sub-clause 4.2.0 and / or otherwise approved by the Engineer shall be treated as approved and accepted for the purpose of fulfilment of the provisions of this Contract.

### 5.0.0 INFORMATION TO BE SUBMITTED

#### 5.1.0 Before tender

Along with the tenders the Tenderers will be required to submit the following Information:

#### 5.1.1 TENTATIVE PROGRAMME

The Tender shall submit a tentative programme based on the information available in the Tender Document and visit to Site indicating the structure wise erection schedule proposed to be maintained by the Contractor to complete the job in time accordance with the Contract.

#### 5.1.2 CONSTRUCTIONAL PLANT AND EQUIPMENT, TOOLS, TEMPORARY WORKS & MANPOWER.

A detailed list of all Constructional Plant & Equipment like cranes, derricks, winches, welding sets, erection tools etc. along with their make, model, present condition and location available with the Tender which he will be able to employ on the job to maintain the progress of work in accordance with the contract shall be submitted along with the Tender. The total number of each category of experienced personnel like fitters, welders, riggers etc. that he will be able to employ on the job shall also be indicated.

#### 5.1.3 ERECTION YARD

A site showing the layout and location of the erection yard proposed to be established by the Tender shall be attached with the Tender indicating the storage space for fabricated steel materials, site-fabrication and repair shop, covered stores, offices, locations of erection equipments and other facilities. The Engineer shall have the right to modify the arrangement and location of the proposed yard to suit site conditions and the Contractor shall comply with the same without any claim whatsoever.

### 5.2 AFTER AWARD OF THE CONTRACT



**STANDARD TECHNICAL  
SPECIFICATION FOR ERECTION OF  
STRUCTURAL STEEL WORK**

PEDC/STD.SPEC/006  
REV 00

Page 15 of 15

HYDERABAD

After award of the contract, the Contractor shall submit the following:-

**5.2.1 DETAILED PROGRAMME**

The Contractor shall submit a detailed erection programme within a month of the award of the Contract for completion of the work in time in accordance with the Contract. This will show the target programme, with details of erection proposed to be carried out in each fortnight, details of major equipment required and an assessment of required strength of various categories of workers to perform a programme approved by the Engineer.

**5.2.2 FORTNIGHTLY PROGRESS REPORT**

The Contractor shall submit fortnightly progress reports in triplicate to the Engineer showing along with necessary photographs, 125 mm x 90 mm size, and All details of actual achievements against the target programme specified in Sub-clause 5.2.1 above. Any shortfall in the achievement in a particular fortnight must be made up within the next fortnight. Along with this report, the Contractor shall Also furnish details of fabricated materials in hand at site and the strength of his workers.



# STANDARD TECHNICAL SPECIFICATION FOR MISCELLANEOUS STEEL WORK

PEDC/STD.SP  
EC/007- REV  
00

Page 1 of 5

HYDERABAD

## MISCELLANEOUS STEEL WORK

REV. NO.	PRAPARED	APPROVED	DATE

### **COPYRIGHT AND CONFIDENTIAL**

The information on this document is the property of BHARAT HEVY ELECTRICAL LTD.It must not be used directly or indirectly in any way detrimental to the interest of the Company.



## STANDARD TECHNICAL SPECIFICATION FOR MISCELLANEOUS STEEL WORK

PEDC/STD.SP  
EC/007- REV  
00

Page 2 of 5

HYDERABAD

### 1. ANCHOR BOLTS

All materials supplied by the Contractor shall be of tested quality as per specification below and test certifications of raw materials shall be provided by the Contractor.

- a) Bolts shall be turned from M.S. conforming to IS: 226 and IS: 422 Grade I.
- b) Nuts shall be hexagonal type conforming to IS: 1363 and IS: 3138.
- c) Plain washers shall be of mild conforming to IS: 226.
- d) Sleeves shall be M.S Tubes (Medium) conforming to IS: 1239.

#### 1.1 FABRICATION

Fabrication of anchor bolts shall be in compliance with the specification Complete anchor bolts assembly shall be as per drawings, and will include the Cost of sleeve pipes, fine gussets, bottom plate, and other fixtures including all welding work if involved.

- a) Threads shall be of coarse type conforming to IS: 1367 and IS: 4218
- a) Plain washers shall be of mild steel conforming IS: 2016.
- c) Bolt shall conform to IS: 1367.

1.2 The anchor bolt assembly to be anchored or embedded in concretes shall be placed and securely held in position strictly as per drawings before and during pouring of concrete, with necessary wooden or steel templates and other devices.

1.3 Tolerances allowed for anchor bolts positioning shall be:

- For sleeved bolts, and one tenth of bolt nominal diameter.
- For bolts without sleeves one twentieth of the bolt nominal dia.

1.4 The surface not to covered with concrete shall be greased and protected from damage by wrapping and typing just cloth/polythene.

#### 1.5 Payment

1.5.1 Payment for supply and fabrication of anchor bolts including sleeves and nuts Shall be on weight basis of the finished product and shall include greasing etc. A sample bolt shall be got approved from Engineer –in-Charge.

1.5.2 Payment for fixing where separately specified shall be on weight basis and rate



## STANDARD TECHNICAL SPECIFICATION FOR MISCELLANEOUS STEEL WORK

PEDC/STD.SP  
EC/007- REV  
00

Page 3 of 5

HYDERABAD

shall including carting, fixing, providing and tying Hessian cloth, welding, if required etc. complete.

### 2 M.S Metal Inserts

- 2.1 All metal inserts its fabrication, bolting, riveting welding, etc. shall conform to the requirement specified under Specification of structural “ Steel “. The metal inserts shall be fabricated as per – drawing and direction of the Engineer- in-Charge.
- 2.2 The placement of the metal inserts shall be securely placed in brick masonry, plain or reinforced concrete members. It shall be so securely placed in member that its position is not disturbed while concreting. Suitable templates, spacer blocks, dummy structures and staging shall be provided. Necessary cutting in the shuttering and adjustment for the placement of metal inserts if situation so desires. Where indicated, it shall be welded to the reinforcement.
- 2.3 The exposed surfaces shall be given one coat of red oxide primer and where directed, protected by jute cloth wrapping and tying.

### 2.4 PAYMENT

Payment shall be made on the basis of actual weight of metal inserts shall include supply, fabrication tying, turning, tack welding, welding on other embedded items such as pipe (for puddle flanges) cutting and adjusting the shuttering and reinforcement and dry packing, if required with cement mortar 1:3 painting, protecting with jute cloth etc. complete.

### 3 M.S. Chequered Plates

- 3.1 Chequered plates shall be 6mm thick (7mm, over chequers and shall conform To IS: 3502). Steel for Chequered plate shall conform to IS: 226. It shall be rolled, and free from harmful surface defects such as cracks, surface flaws etc. The plates shall be cut to shape and fixed to bearing members as shown in the relevant drawing and as directed by Engineer-in-Charge. The edges shall be made smooth and no burs or jagged end shall be left. The plates may be spliced with prior consent of Engineer –in-Charge but in that case care should be taken so that there is continuity in the pattern of the plates between the two portions.

### 3.2 Payment

Payments shall be made on the basis of weight of Chequered plate actually laid. The rate shall include cost of cutting to size, making holes to required shape, smoothing ends, transporting and welding, bolting, fixing, in positions etc. complete. No deductions will be made for openings up to size of 300mm square.

### 4. M.S. Grating



## STANDARD TECHNICAL SPECIFICATION FOR MISCELLANEOUS STEEL WORK

PEDC/STD.SP  
EC/007- REV  
00

Page 4 of 5

HYDERABAD

- 4.1 Material: Both the types of Gratings shall be fabricated, out of M.S. Flats. The steel shall conform to IS: 236 and shall be of weld able quality. It shall be clearly rolled and shall be free from harmful surfaces defects.
- 4.3 Fabrication Drawings: Based on the arrangement of supporting beams of design Drawings, the Contractor shall prepare shop fabrication drawings and get the Same approved as per the procedure outlined for shop fabrication drawings for structural steel work.
- 4.2 Type I Gratings
- 4.5.1 These shall be of ready made bought out type and designed to carry specified loads with limits.
- 4.5.2 Unless other wise mentioned in schedule of rates these shall be capable of carrying a uniformly distributed load of 500 kg. per square metre or a concentrated loads of 1000 kg. at mid span , whichever is governing . The maximum span for the above loading condition shall be 1200 millimetres. The deflection shall not exceed span /200 or 6mm whichever is less. The design shall be done as per IS: 800. Before fabrication or procurement the contractor shall submit the design calculations, drawings and manufacturer's Literature and gets the same approved from Engineer –in-Charge.
- 4.5.2 The gratings for stair treads shall be provided with nosing of Chequered plate of approved size and thickness.
- 4.6 Payment
- 4.6.1 Gratings shall be paid on the basis of weight of the area of M.S. Grating and frame actually laid.
- 4.6.3.1 The rate shall include cost of preparation of fabrication drawings, calculations, cost of cutting to size fabricating, welding, bolting, smoothing ends if necessary shop coat of red oxide zinc chromate primer, transporting and fixing in positions by welding or clips as per the design drawings.
- Loading, unloading, strong, safe custody, watch and ward, returning back of surplus materials to go down of issue where applicable.

### 5 M.S. Tube Hand Rails.

- 5.1 All mild steel tubes and fittings shall conform IS: 1239 and shall be of medium grade. All screwed pipes shall have threads as per IS: 554. All fittings shall be malleable iron fittings as approved by Engineer-in-Charge.
- 5.2 All pipes shall either be directly welded or jointed with screwed couplings. Care shall be taken to remove burrs from the ends of the pipe and if required the vertical members should be grouted with cement mortar as specified. The pipe shall be fixed to pipe or angle uprights by means of suitable



## STANDARD TECHNICAL SPECIFICATION FOR MISCELLANEOUS STEEL WORK

PEDC/STD.SP  
EC/007- REV  
00

Page 5 of 5

HYDERABAD

clamps or by means of welding. After fixing, the pipe shall be painted with two coats of white paint over a coat of primer as directed by Engineer-in-Charge.

### 5.3 Payment

The payment shall be made on running metre basis of the actual of handrails fixed and shall include the cost of pipes. Clamps and fittings, if any, transportation, cutting of pipes as required, threading or welding, fixing painting etc .all complete as per direction of the Engineer-in-Charge.

### 6 M.S. Rungs

6.1 M.S.bars used for rungs shall conform IS: 432 and shall be fixed in positions as per detailed drawings and directions of Engineer-in-Charge.

### 6.2 Payment

Payment shall be made of the basis of actual weight in kilogram (kg) of M.S. rungs.

## 7 EXPANSION FASTENERS

### 7.1 SCOPE

The specification deals with the use of expansion fasteners for providing fixture to concrete surfaces.

### 7.5 Installation Procedure

The Contractor shall install the expansion at the specified places according to the approved manufactures specification with the help of necessary tools specified by the manufactures with the prior approval of Engineer –in-Charge for the approval of Engineer-in-Charge for every installation of expansion fasteners in regard to its correct location and strength.

### 7.6 Payment

Payment shall be made on number basis. The rate shall include cost of fasteners, nuts, washers and bolts of required sizes necessary scaffolding, drilling with electric drill, labour, materials, complete.



HYDERABAD

**STANDARD TECHNICAL SPECIFICATION  
FOR MISCELLANEOUS METAL**

PEDC/STD.SPEC/008  
REV 00

Page 1 of 5

**MISCELLANEOUS METAL**

REV. NO.	PRAPARED	APPROVED	DATE

**COPYRIGHT AND CONFIDENTIAL**

The information on this document is the property of BHARAT HEVY ELECTRICAL LTD.It must not be used directly or indirectly in any way detrimental to the interest of the Company.



HYDERABAD

## STANDARD TECHNICAL SPECIFICATION FOR MISCELLANEOUS METAL

PEDC/STD.SPEC/008  
REV 00

Page 2 of 5

### 0.0 SCOPE

This shall include supply, fabricators and erection of miscellaneous metal items of light nature in gates, grills balcony and steps handrails particulars structural mullions and transoms, ladders hangers masonry anchors, shell angles, anchor bolts fasters etc. as shown or drawing or as instructed by the Engineer. The above items shall be of fabricated or cast M.S./Aluminium Brass. Cast iron .M.S. and galvanised M.S sheets aluminium sheets expanded metal with mesh etc. as shown on drawings and/or described in the Schedule of items.

### 1.0 INSTALLATION

#### 2.1 Fabrication/Casting

##### 2.1.1 General

All work shall be done according to approved shop drawings. All workmanship shall be equal to the best practice in modern structural foundry shop.

##### 2.1.2 Shop Connections

- a) All shop connections shall be riveted or welded except when noted otherwise on drawings.
- b) Welding of steel shall be done on accordance with the IS: 816. Use of metal are welding for general construction in Mild Steel.
- c) Welding of Aluminium shall be done in accordance with IS : 2912. Are welding of aluminium and alloys. Special care shall be taken to grind smooth all welded surface that shall remain exposed to view Welds shall be electrically continuous if so required by ; the Engineer.

##### 2.1.3 Shop Coat

Before leaving the shop, all metal work shall be thoroughly cleaned by effective means of all loose mill/scale, rust and foreign matter. Except where encased in concrete all steel work shall be given one coat of approved metal protective paint, applied by ; brush thoroughly evenly, well worked in to joints and other open spaces. All paint shall be applied to dry surfaces. When specified on Schedule, steel work shall be galvanised or galvanised and painted with a coat of zinc chromate primer Aluminium surfaces which shall come in contact with masonry shall be given one coat of bituminous paint

#### 2.2 Erection

##### 2.2.1 Bracing



HYDERABAD

## STANDARD TECHNICAL SPECIFICATION FOR MISCELLANEOUS METAL

PEDC/STD.SPEC/008  
REV 00

Page 3 of 5

The Contractor shall provide all necessary temporary guys and braces to ensure alignment and stability of the members and to take care of all loads to which the structure may be subjected including erection of equipment and operation of the same.

### 2.2.2 Temporary Bolting- Up

As erection proceeds the Contractor shall plumb up and level all members and shall securely bolt up to take care of all dead load. Wind load and erection stresses. Wherever piles of materials erection equipment or other loads are carried during erection . proper provision shall be made to take care of the stresses resulting from the same.

### 2.2.3 Turned Bolt

For field connections where bolting is specified, holes for the turned bolts may be reamed in the field, if required. All drilling or reaming for turned bolts shall be done after the parts to be connected are assembled.

### 2.2.4 Welding

Where specified on drawings, welding shall be done in accordance with IS:816 for steel and IS:2812 for Aluminium and Alloys.

### 2.2.5 Cutting and Fitting

No cutting of sectors, flanges, webs of angles should be done without the approval of the Engineer. Where indicated on the drawings, holes cuttings etc. shall be provided as regulated for installation, to the work by the other Contractors. No additional holes or cuttings their those shown on drawings, shall be made without the approval of the Engineer.

### 2.2.6 Drifting

Correction of minor misfits and a reasonable amount of reaming and cutting of excess stock from rivets may be permitted. For this, light drifting may be allowed to draw holes together. Twist drills shall be used to enlarge as necessary to make connections Reaming that weakens the members or make it impossible to first the holes properly or to adjust accurately after ream one shall not be allowed.

Any error in shop work which prevents the proper assembling and fitting of parts by moderate use of draft pans of a moderate amount of reaming and slight chipping and cutting shall immediately be called to the attention of the Engineer and approval of the method of confection obtained. The sue of cutting torches to enlarge or alter rivet holes shall not be permitted.

### 2.2.7 Grouting



HYDERABAD

## STANDARD TECHNICAL SPECIFICATION FOR MISCELLANEOUS METAL

PEDC/STD.SPEC/008  
REV 00

Page 4 of 5

All beaming plates, loose, lintels and beams etc. shall be set to proper grade and level by the Contractor and the Engineer's approval obtained before proceeding with the Grouting. Grouting shall be done in 1:1 1/2:3 concrete with 5mm down stone chips.

### 2.2.8 Anchor Bolting

When shown on drawings, the miscellaneous metal items shall be fixed to crete by case hardened and drawn carburizing steel expander nut and bolt. The contractor shall submit the manufacturer's literature shown the average pull out and average shear values for bolts of various sizes. The bolts shall be fixed strictly as per the manufacturer's instructions.

### 2.2.9 Pipe Joints

M.S. Pipes shall be joined by threaded sockets or by welding Cast iron pipes shall be socket and spigot jointed and caulked with hemp and molten head.

### 2.2.10 Spot Painting

All field rivets and bolts and also any serious abrasion to shop paint shall be spot painted with the same materials and used for the shop paint or equivalent.

### 2.2.11 Making Good

All cutting to concrete or masonry shall be made good to the satisfaction of the Engineer.

## 3.0 ACCEPTANCE CRITERIA

- a) All items shall be of correct shape, size, weight etc., shown on drawings and schedule of items.
- b) For installed items, the tolerances shall be follows:
  - i) Permissible deviation from straightness –1 in 1000.
  - ii) Seats, stiffener connections etc, shall be as per approved drawings and shall not interfere with architectural clearances.
- c) All castings shall be free from blow holes, cracks and other blemishes.

## 4.0 RATES

The Contractor shall quote unit rate for supply of materials fabrication, shop paint and erection. This shall also include transporting the fabricated materials to the site, unloading storing and erection, including furnishing necessary temporary bracings guys, staging and planking. This shall also include cutting and drilling to steel, concrete or masonry and welding, bolting, grouting and making good damages after erection and removing all rubbish and clearing the site upon completion of erection.



HYDERABAD

## STANDARD TECHNICAL SPECIFICATION FOR MISCELLANEOUS METAL

PEDC/STD.SPEC/008  
REV 00

Page 5 of 5

Where only erection of materials supplied by the Owner at site to actual erection site, erection including free of cost is involved, the rate shall include handling, transportation from the Owner's stores at site to actual erection site, erection including furnishing necessary temporary bracing, guys, staging and planking etc., complete with all cutting drilling welding grouting bolting etc., making good damages removing all debris on completion of the job.

### 5.0 METHOD OF MEASUREMENT

- a) For supply and/installation generally, cast items except pipes shall be measured for actual numbers used or for weight as mentioned in the Schedule.
- b) Cast Iron rain water down corners or drain pipes shall be measured for length along the center line of piping including all bends, joints shoes and specials.
- c) Fabricated items shall be measured for weight.
- d) Ornamental metal grills, gates etc., shall be measured either for weight or area or such grills, gates etc.

### 6.0 I.S CODES

- IS:226 - Structural Steel (Standard Quality)
- IS:800 - Code of Practice for use of structural steel in general building construction.
- IS:816 - Use of metal arc welding for general construction
- IS:2812 - Arc Welding of Aluminium and Alloys
- IS:3150 - Hexagonal Wire Netting
- IS:4948 - Welded steel wire fabric for general use.



**STANDARD TECHNICAL  
SPECIFICATION FOR PAINTING ON  
STRUCTURAL STEEL**

PEDC/STD.SPEC/09  
--REV 00

Page 1 of 4

HYDERABAD

**PAINTING ON STRUCTURAL STEEL**

REV. NO.	PRAPARED	APPROVED	DATE

**COPYRIGHT AND CONFIDENTIAL**

The information on this document is the property of BHARAT HEVY ELECTRICAL LTD.It must not be used directly or indirectly in any way detrimental to the interest of the Company.



## STANDARD TECHNICAL SPECIFICATION FOR PAINTING ON STRUCTURAL STEEL

PEDC/STD.SPEC/09  
--REV 00

Page 2 of 4

HYDERABAD

### 1.0 SCOPE

- 1.1 This specification covers the general requirements for painting structural steel work. It covers the supply and delivery of all necessary materials, labour, scaffolding, tools, equipment and everything that for the job completion on schedule.
- 1.2 The scope of painting work could be one or more of the following.
- Shop painting after fabrication.
  - Painting after erection.
  - Painting after fabrication and painting after erection.
  - Routing maintenance painting or repainting of erected structural steel.
- 1.3 Shop painting shall be understood to mean painting prior to erection whether such Materials are fabricated in shop or at site. In case the contract covers shop painting only, the contractor shall ensure that the painted surfaces are not abraded/scratched etc, as they leave his works/shops. In case of ex-works delivery contract and in case of FOR site contracts, the materials as received at site should be good condition. Otherwise all damaged, abraded and scratched surfaces shall be touched up on receipt of materials at site as specified. If the contract covers both shop painting and painting after erection, the responsibility would be total. In Case of routine maintenance painting of erected steel work, the surface preparation, primer application and painting shall be as per the instructions of the Engineer.

### 2.0 APPLICABLE CODES

The following Specifications, Standards and Codes are made a part of this Specification. All standards, tentative specifications, Specifications and Codes of Practice referred to here in shall be the latest editions including all applicable official amendments and revisions.

In case of discrepancy between this Specification and those referred to herein, this Specification shall govern, In case as discrepancy between tender drawings and this Specification of the tender drawings shall govern.

In case of discrepancy between this Specification and those referred to herein, this Specification shall govern, In case as discrepancy between tender drawings and This Specification of the tender drawings shall govern.

- IS : 800 Code of practice for Use of Structural Steel in General Building Construction.
- IS: 012 Ready Mixed paints, Brushing, Red Lead, Non setting, Priming.
- IS : 129 Ready Mixed Paint, Brushing, Finishing, Interior, Oil glass, for General purposes, to Indian Standard colours.



**STANDARD TECHNICAL  
SPECIFICATION FOR PAINTING ON  
STRUCTURAL STEEL**

PEDC/STD.SPEC/09  
--REV 00

Page 3 of 4

HYDERABAD

- d) IS : 157 Ready Mixed Pints, Brushing, Acid and Alkali Resisting, Lead Free, for General Purposes, to Indian Standard Colours No.446 Red Oxide, NO.632 Dark Admiralty Grey and other colours as required.
- e) IS : 159 Ready Mixed paint, Spraying, Acid Resisting, for protection against Acid Fumes, Colour as required.
- f) IS : 160 Ready Mixed paint, Spraying, Acid Resisting, for protecting against Acid Fumes, Colour as required.
- g) IS : 341 Black Japan, Types A,B,c
- h) IS : 1236 Ready Mixed Paint, Brushing, Oil Gloss, Heat Resisting, to Indian Standard Colour No630 Deep Buff.
- i) IS : 1477 code of practice for painting of Ferrous Metals in Buildings.  
(part-I) - pre-treatment  
(part-I) – painting.
- j) IS : 2074 Ready Mixed paints, Red Oxide – Zinc chrome, priming.
- k) IS : 2330 Aluminium paint for General purposes, in Dual Container.
- l) IS : 5905 Sprayed Aluminium and Zinc Coatings on Iron and Steel.

**2.0 PAINT**

- 3.1 All paints delivered to the fabrication shop/site shall be ready mixed, in original Sealed containers, as packed by the paint manufactures and no thinners shall be Permitted.
- 3.2 Paint shall be stirred frequently to keep the pigment in suspension.

**3.0 WORKMANSHIP**

- 4.1 The surface of steel works to be painted in the shop shall be thoroughly cleaned for All loose mill scale, rust, grease, dirt and foreign matter by hand tool cleaning, Power tool cleaning, flame cleaning or sand / shot blasting as specified in Data Sheet A. In power tool brushing, sufficient care shall be exercised no to burnish mill scale to a slick finish to which paint may not adhere property.
- 4.2 All fabricated steel martial, except those to be galvanised shall receive protective Paint coating of red Oxide Zinc chromate or as specified in schedule of items.
- 4.3 The paint treatment shall be applied either by brushing or spraying on the



## STANDARD TECHNICAL SPECIFICATION FOR PAINTING ON STRUCTURAL STEEL

PEDC/STD.SPEC/09  
--REV 00

Page 4 of 4

HYDERABAD

thoroughly cleaned and dry surface, Airless spraying shall be done if so specified. The number or coats of paint shall be one or as specified in schedule of items.

- 4.4 Surface inaccessible after assembly shall receive an additional coat for the specified paint prior to assembly.
- 4.5 Steel delivered at the erection site be touched up with the specified paint on surface which are scratched.
- 4.6 After steel has been erected, all bare and abraded spots, rivet heads, field welds, Bolt heads and nuts shall be painted with primer specified in Data Sheet A. Before paint is applied, the surface shall be dry and free from dust, dirt, scale, oil and grease.
- 4.7 Surface inaccessible after erection, including top surface of floor beams shall Receive treatment with one additional coat of red oxide zinc chromate primer.
- 4.8 No painting shall be done in frosty/foggy weather or when the humidity is high Enough to cause condensation on the surface to be painted. Paint shall not be applied when the temperature of surface to be painted in 5<sup>0</sup>C or lower.
- 4.9 In addition, colour code marking as specified shall be clearly painted in the Fabrication shop on the member in the manner specified.
- 4.10 Separate colours code of identification mark shall be adopted in the fabrication Shop for member fabricated from steel supplied by the OWNER and the VENDOR/CONTRACTOR
- 4.11 Surfaces coming in contact with concrete, and such other areas should not be painted, if so specified or directed by Engineer.
- 4.12 All machine finished surface shall be provided with a coat of white lead tallow Before despatch to site to prevent rust formation.

### 4.0 METHOD OF PAYMENT

- 5.1 Payment for painting of structural steel works shall be made on the basis of weight in metric tons of the painted structures accepted by the Engineer-in- charge. The rate shall include supplying and applying two coats of synthetic enamel paint of approved quality and shade over a coat of red oxide zinc chromate primer besides one coat of shop primer already applied to structure steel works of all types/ shapes at all locations & positions including storage, surface preparation, degreasing, cleaning, drying, touching up of shop primer coat, providing temporary staging, testing etc, all complete as specified.



HYDERABAD

**STANDARD TECHNICAL  
SPECIFICATION FOR  
INSERTS/EMBEDMENTS IN  
CONCRETE WORK**

PEDC/STD.SPEC/  
10- REV 00

Page 1 of 3

**INSERTS/EMBEDMENTS IN CONCRETE WORK**

REV. NO.	PRAPARED	APPROVED	DATE

**COPYRIGHT AND CONFIDENTIAL**

The information on this document is the property of BHARAT HEVY ELECTRICAL LTD.It must not be used directly or indirectly in any way detrimental to the interest of the Company.



**STANDARD TECHNICAL  
SPECIFICATION FOR  
INSERTS/EMBEDMENTS IN  
CONCRETE WORK**

PEDC/STD.SPEC/  
10- REV 00

Page 2 of 3

HYDERABAD

**1.0 SCOPE**

This specification source the general the requirement for providing insert and cut out concrete work as indicated in the drawings supplied to the contractor.

**2.0 GENERAL**

Numerous insert are requirement to be fixed/embedded in concrete as indicated In construction drawing/as directed by the Engineer. These insert comprise plates, angle, pipe sleeves, anchor bolts assemblies, owner, etc to be supplied by owner free of coat at his stores, for incorporation in the works, other inserts are required to be supplied and fabricated, by the Contractor These would be indicated clearly on the construction drawings.

**3.0 MATERIALS AND INSTALLATION**

3.1 Steel templates shall be used by the CONTRACTOR to locate and very accurately position bolts, group of inserts, inserts, embedded parts, etc, at his cost. Such templates shall be got previously approved by the Engineer. Templates shall invariably be supported such that the same is not disturbed due to vibration, movement of labours, materials, shuttering work, reinforcement, etc, while concreting. The CONTRACTOR will have to suitably bend, cut or otherwise adjust the reinforcement in concrete at the location of inserts, as directed by the Engineer. If the Engineer so directs, the insert will have to be welded to reinforcement to keep these in place. The contractor shall be responsible for the accuracy of dimensions, levels, alignments and canter lines of the insert in accordance with the drawings and for maintenance of the same until the erection of equipment structure or final acceptance by the Owner.

3.2 The Contractor shall ensure proper protection of all bolts, inserts, etc, from weather by greasing or other approved means such as applying white lead putty and wrapping them in gunny bags or canvas or other means as directed by the Engineer to avoid damage due to movement of his labourers, materials, equipment etc. No extra claim from the Contractor on this account shall be entertained. The contractor shall be solely responsible for all the damage caused to bolts inserts, etc, due to his negligence and in case damage does occur, they shall be rectified to the satisfaction of the Engineer at the Contractor's cost.

**4.0 RATE**

4.1 The rate quoted by the Bidder for embedment works shall hold good for accurately fixing the inserts at the correct-levels/alignment and shall include the cost of templates and any temporary supports/anchors etc, including cutting, bending , welding, etc as requirement.

**5.0 MEASUREMENT:**

All embedment will be measured by weight including lugs.



**STANDARD TECHNICAL  
SPECIFICATION FOR  
INSERTS/EMBEDMENTS IN  
CONCRETE WORK**

PEDC/STD.SPEC/  
10- REV 00

Page 3 of 3

HYDERABAD

Templates and temporary supports, if any will not be measured.

Permanent supports such as road, structural sections etc, used exclusively for supporting the embodiments shall be paid for under ordinary embodiments (not under Foundation hardware).



HYDERABAD

# STANDARD TECHNICAL SPECIFICATION FOR GROUTING

PEDC/STD.SPEC/11  
REV 00

Page 1 of 4

## GROUTING

REV. NO.	PRAPARED	APPROVED	DATE

### **COPYRIGHT AND CONFIDENTIAL**

The information on this document is the property of BHARAT HEVY ELECTRICAL LTD.It must not be used directly or indirectly in any way detrimental to the interest of the Company.



HYDERABAD

## STANDARD TECHNICAL SPECIFICATION FOR GROUTING

PEDC/STD.SPEC/11  
REV 00

Page 2 of 4

### 1.00.0 GROUTING OF BASE PLATES

#### 1.01.0 GENERAL

Grouting under base plates constitute a special kind of work requiring judicious selection of materials and careful execution of work. Grouting should ensure complete filling of the space and perfect bond. The grouting shall be done under Expert supervision. Care must be taken to ensure that there is no locked air in the grouting.

#### 1.02.0 MATERIALS

1.02.01 CEMENT : Only fresh Portland conforming to IS:8112

1.02.02 SAND : Fine aggregate shall comply in general with requirement of concrete aggregate (IS:383) and shall have a fineness modules of 2.5 to 3.0

1.02.03 ANTI-SHRINKAGE MATERIAL : Aluminium powder or anti-shrinkage admixture like Groutex CRS-NS grout (by Cement Research Institute of India) or conbextra GP2 its equivalent shall be of standard brand from reputed manufactures And shall be approved by the Engineer prior to use in work.

#### 1.02.03 MORTAR

Water cement ratio should not exceed 0.5 Mortar shall be made up of cement and sand in the proportion 1:1 by weight and blended with Aluminium powder (about 0.005 by weight of cement or with anti –shrinkage admixture) in a suitable proportion to cement mortar in accordance with the recommendation of the manufacturer and subject to the approval of the Engineer.

#### 1.04.0 SCOPE

The work covers all operation connected with grouting including all labour and materials. Any damage to the concrete foundation works caused during such operations due to the carelessness, or negligence shall be made good by the Contractor in a manner to be decided by the Engineer, whose decision shall be final and binding.

#### 1.05.00 SURFACE PREPARATION: CONCRETE

Concrete surface receiving the grout shall be properly roughened removing latency and exposing good concrete. The preparation of the surface may be accomplished through the use of a chipping hammer or hand bush hammer and wire brush. The surface shall be thoroughly cleaned removing all the free water from the surface but keeping it wet before the grouting begins.



HYDERABAD

## STANDARD TECHNICAL SPECIFICATION FOR GROUTING

PEDC/STD.SPEC/11  
REV 00

Page 3 of 4

### 1.06.0 SURFACE PREPARATION:STEEL

The steel surface coming in contact with the grout should be cleaned or rust, mill scales, paints, oil or grease and be wet before setting into place for grouting.

### 1.07.0 WORKMANSHIP

Grouting arrangements should ensure mortar to fill all the voids completely. Provisions of grout holes and rod ding arrangements should be checked before commencement of grouting. If necessary, pressure grouting with grout pump shall be restored to. Edges shall be finished properly.

### 1.08.0 METHODS OF GROUTING

#### 1.08.01 USE OF DRY PACK CONCRETE

The widely used method of obtaining satisfactory grout is based on the principle of using lowest water cement ratio reducing the shrinkage to a minimum. Pozzolana cement having less shrinkage than ordinary Portland cement is preferred for this grouting. Only enough water shall be added to produce a grout. The proper amount of mixing water and proper consistency are those which will produce a grout which is at the point of becoming rubbery when the material is solidly packed. Any mortar which has been mixed for period longer than an hour shall not be used.

#### 1.08.0 USE OF DRY PACK CONCRETE

To reduce the shrinkage anti-shrinkage materials as specified earlier to be added.

#### 1.08.02 LEVELLING & PLUMBING

No grouting shall be carried out until the steel-works shall be finally levelled and plumbed and sufficient number of floor beams are tied in position. The stanchions, meanwhile, are to be supported by steel wedges, and immediately Before grouting, the space under steel base plate shall be thoroughly cleaned. The steel wedges must not be welded to the underside of base places.

### 2.00.0 DISMANTLING, ALTERATION AND RE-ERECTION OF STEEL WORK

In case it is found that alteration are to be done for certain portions of steel work already erected for any reasons what so ever, this shall be done only on the written orders of the Engineer. Complete scheme of alterations shall be detailed and got approved by Engineer before work is taken up at site.

The sections requiring modifications which cannot be done in the erected position shall be dismantled carefully without damaging other structure, lowered dismantling, cutting, re-welding or supporting, re-aligning of other adjacent connected member as well.

### 3.00.0 MEASUREMENT

3.00.01 Grouting under base plates of structures erected by the Contractor will not be



HYDERABAD

## STANDARD TECHNICAL SPECIFICATION FOR GROUTING

PEDC/STD.SPEC/11  
REV 00

Page 4 of 4

measured. The rate for erection is expected to include cost of grouting However, Volume of grout will be considered for the purpose of theoretical consumption of cement.

3.00.02 Grouting under base plates and machine bases erected by other will be measured for actual volume of grout. The volume of embedded base plate/machine basis will be deducted from the overall volume of grout.

3.00.03 Grouting in pocket for erection done by other will be measured for the volume of Of pockets. No deduction will be done for volume of bolts etc.



**STANDARD TECHNICAL  
SPECIFICATION FOR MASONRY  
AND ALLIED WORKS**

PEDC/STD.SPEC/12  
REV 00

Page 1 of 8

HYDERABAD

**MASONRY AND ALLIED WORKS**

REV. NO.	PREPARED	APPROVED	DATE

**COPYRIGHT AND CONFIDENTIAL**

The information on this document is the property of BHARAT HEAVY ELECTRICALS LTD. It must not be used directly or indirectly in any way detrimental to the interest of the Company.



**STANDARD TECHNICAL  
SPECIFICATION FOR MASONRY  
AND ALLIED WORKS**

PEDC/STD.SPEC/12  
REV 00

Page 2 of 8

HYDERABAD

**1.0.0 SCOPE**

This specification covers furnishing, installation, repairing, finishing, cutting, protection, maintenance and handing over of masonry and allied works of use in structures and locations covered under the scope of the Contract.

**2.0.0 INSTALATION**

**2.1.0 SOLING**

**2.1.1 BRICK SOLING**

The ground shall be dressed, consolidated by ramming or by light rolling and a 12mm thick cushion of sand laid. On the sand cushion the bricks shall be laid with fine joints and placed firmly in position by hammering with wooded mallet. The surface shall be free from undulations. The “frog” side shall be on the underside. The joints shall be broken the in all direction and bricks cut as required. The pattern of laying and number of layers shall be as per Schedule of item. Orientation shall be as designed by the Engineer. After laying of each layer of brick sand shall be spread over and worked into the joints to pack the bricks tight.

**2.1.2 STONE SOILING**

The stones for soling shall be selected on the basis of thickness of soling specified in the Schedule of Items. The larger stones shall be laid and the gaps filled by smaller stones. The interstices shall then be firmly packed with sand by flooding with water.

**2.2.0 BRICKS EDGING**

Excavation shall be done closed to the brick dimensions in perfect alignment. Bricks shall be firmly placed by hammering with wooden mallets and sides and joints packed firmly with earth so that the edging is not disturbed easily. Alignment and level shall be acceptable to the Engineer.

**2.3.0 MASONRY**

**2.3.1 GENERAL**

All masonry work shall be true to lines and levels and as shown on drawings. All Masonry shall be tightly built against structural members and bonded with dowels, inserts etc, as shown on drawings.

**2.3.2 MORTAR**

Mix for mortar shall be specified in the Schedule of Items.



## STANDARD TECHNICAL SPECIFICATION FOR MASONRY AND ALLIED WORKS

PEDC/STD.SPEC/12  
REV 00

Page 3 of 8

HYDERABAD

When lime is used hydrated lime shall be mixed with water to form a putty and stored with care to prevent evaporation for at least 24 hours before use, Quick lime shall be slaked with enough water to make a cream, passed through a No.10 sieve and stored avoiding evaporation for seven days before use.

Lime putty and sand in proper proportion shall be mixed on a water-light platform with necessary addition of water and thoroughly ground in a mortar mill. This mix shall be transferred to a mechanical mix, required quantity of cement added and the content mixed for at least 3 minutes. Mixtures of lime putty and sand may be stored avoiding drying out. For cement sand mortar cement and sand in requisite proportions shall be mixed dry in a mechanical mixer and then water added and mixed further. Minimum quantity of water shall be added to achieve working consistency. Surplus mortar droppings from masonry, if received on surface free from dirt may be mixed with rest mortar if permitted by the Engineer who may direct addition of additional cement without any extra payment. No mortar which has stood for more than half an hour shall be used.

### 2.3.3 BRICK MASONRY

Bricks shall be soaked by submergence in clean water for at two hours in approved vats before use. Bricks shall be laid in English bond unless specified otherwise. Broken bricks shall not be used. Cut bricks shall be used if necessary to complete bond or as closures. Bricks shall be laid with frogs upwards over full mortar beds. Bricks shall be pressed into mortar and tapped into final position so as to embed fully in mortar. Inside faces shall be buttered with mortar before the next bricks is placed and passed against it. Thus, all joints between bricks shall be fully filled with mortar.

Mortar joints shall be kept uniformly 10mm thick. All joints on face shall be raked to minimum 10 mm depth using raking tool while the mortar is still green to provided bond for plaster or pointing. Where plaster or pointing is not provided, the joints shall be struck flush and finished immediately. Brickworks two bricks thick or more shall have both faces in true plane. Brickwork of lesser thickness shall have one selected face in true plane.

### 2.3.4 EXPOSED BRICKWORK

Brickwork in superstructures which is not covered by plaster shall be as shown on drawing and executed by specially skilled mason. Courses shall be truly horizontal and vertical truly vertical. Wooden straight edges with brick course graduations and position of window sills and lintels shall be used to control uniformly of brick courses. Masons must check workmanship frequently with plumb, spirit level, rule and strings. All brickwork shall be cleaned at the end of dry work. If face bricks are specified in the Schedule of item, the brickwork shall be in routine bricks, but maintaining the bond fully. Where face bricks are not specified, bricks for the exposed brickwork on completion of work shall be rubbed down, washed clean and



## STANDARD TECHNICAL SPECIFICATION FOR MASONRY AND ALLIED WORKS

PEDC/STD.SPEC/12  
REV 00

Page 4 of 8

HYDERABAD

pointed as specified. Where face bricks are used carborundum stone shall be used for rubbing down.

### 2.3.5 REINFORCED BRICKWORKS

Reinforcements shall be as specified in the Schedule of Items. All reinforcements shall be thoroughly cleaned and fully embedded in mortar. Where M.S. bars are used as reinforcement, these shall be laced with dowels if left in R.C. columns or welded to steel stanchions.

### 2.3.6 REINFORCED BRICKWORKS

Reinforcements shall be as specified in the Schedule of Items. All reinforcements shall be thoroughly cleaned and fully embedded in mortar. Where M.S. bars are used as reinforcement, these shall be laced with dowels if left in R.C. columns or welded to steel stanchions.

### 2.3.7 STONE MASONRY

Stones shall be thoroughly soaked before laying. Stones shall be laid on their natural quarry beds. Individual stones shall be executed by specially skilled mason. Stones used for exposed face shall be specially selected. All exposed stone faces shall be kept clean and free from mortar and pointed up neatly as the work proceeds in a manner called for in the drawings or the Schedule of Items or Instructions. A sample wall, 10 sq.m. in area shall be built and approved by the Engineer and all works shall match with this sample.

### 2.3.8 COMPOSITE MASONRY

Where stonework facing with brick masonry backing is specified the bond between them shall be achieved by bond stones of dimensions and frequency as desired by the Engineer.

### 2.3.9 EXPANSION & SEPARATION JOINTS

Location of joints shall strictly be as shown on drawings or as instructed by the Engineer. Expansion joints shall be as shown on drawings and specified in the Schedule of Items. Expansion joint filler boards and sealing strip shall have minimum transverse joints. Transverse joints shall meet the approval of the Engineer.

Separation joints shall be with standard water proof paper or with alkathene sheets about 1mm in thickness. Length and sealing of laps shall be to the satisfaction of the engineer.



# STANDARD TECHNICAL SPECIFICATION FOR MASONRY AND ALLIED WORKS

PEDC/STD.SPEC/12  
REV 00

Page 5 of 8

HYDERABAD

## 2.3.10 MOULDINGS, CORNICES, DRIP COURSE

These shall be made as shown in drawings. Bricks or stone shall be cut and dressed as required. If no subsequent finish is envisaged, these shall be rubbed to correct profile with carborundum stone.

## 2.3.11 CURING

Masonry shall be cured by keeping it wet for seven days from the date of laying. In dry whether at the end of days work top surface of masonry shall be kept wet by ponding.

## 2.3.12 EMBEDDING OF FIXTURES

All fixtures shall generally be embedded in mortar and masonry units shall cut as required.

## 2.3.13 ENCASING OF STRUCTURE STEEL

This shall be done by masonry work round flanges, webs etc. and filling the gap between steel and masonry by minimum 12 mm thick mortar. Encased members shall be warped with checked wire mesh shown on drawings of instructed by the Engineer. The minimum lap is checked wire mesh shall be 50mm

## 2.4.0 DAMP PROOF COURSE

Unless otherwise specified Damp-proof course shall be 40 mm Thick 'artificial stone' proportion 1:1-2/3 cement sand stone-chips (10mm down) with admixture of a waterproof compound as approved by the Engineer. The percentage of admixture shall be as manufacture's specifications but not less than 2% weight of cement. The top surface shall be double chequered cured by ponding for seven days.

## 2.5.0. DAMP PROOF MEMBRANE

Damp proof treatment using fibre or hessian base bitumen felt shall be 6,8 or 10 course treatment is specified in IS:1609. The number of courses shall be as mentioned in the schedule of items. Sequence or work shall be as directed by the Engineer. Extreme sequential care shall be taken to prevent damage to felt during and after laying. The contractor shall be obliged at the own expense, if to rectify and leakage appearing within 5 years of installation by removing and renewing the coats at the point of leakage.

Where shown on drawing damp proof measurance with one layer bitumen paper or one land alkathene sheet shall be laid with minimum 150 mm lap under sides on grade.



**STANDARD TECHNICAL  
SPECIFICATION FOR MASONRY  
AND ALLIED WORKS**

PEDC/STD.SPEC/12  
REV 00

Page 6 of 8

HYDERABAD

**3.0.0 RATES**

Rates shall be units rates for the complete work as detailed out in the Specification unless any particular portion is specifically in the Schedule of Item.

**4.0.0 METHOD OF MEASUREMENT**

**4.1.0 SOLING**

Soling of different types as enumerated in the Schedule of Items shall be measured on actual area basis.

Deductions shall not be made for areas less than 0.1 Sq.M.

**4.2.0 BRICK EDGING**

Edging shall be measured on running length unless included in other relevant items.

**4.3.0 MASONRY**

**4.3.1** Thickness of brick walls shall be measured in normal brick sizes.

**4.3.2** For masonry work exceeding 150mm in thickness, actual volume of work shall be measured and deductions for opening, lintels, sills, conduit ducts, pipes etc., shall be made. No opening less than 0.1 Sq.M Min area shall however be deducted.

**4.3.3** No deductions shall be made for embedded fixtures nor any extra by paid for the mortar used for fixing or for necessary cutting of bricks.

**4.3.4** For encasing of steel beams, columns etc. the sizes as shown on drawings shall be measured and deductions made for the volume of encased steel.

**4.3.5** No extra payment shall be for cutting of masonry units.

**4.3.6** Walls 150mm in thickness or les shall be measured for actual area of works and deductions made as in Clause 4.3.2.

**4.3.7** Exposed brickwork using selected ordinary brick or free bricks for the exposed face shall be measured in area as an extra over the ordinary brickwork if no provided in the Schedule of Items. It shall be measured by volume including the composite backing if so provided in the Schedule. Deductions shall be as described in Clause 4.3.2

**4.3.8** Reinforcements shall be measured and paid separately under relevant items in the schedule unless included in the items for masonry work.



**STANDARD TECHNICAL  
SPECIFICATION FOR MASONRY  
AND ALLIED WORKS**

PEDC/STD.SPEC/12  
REV 00

Page 7 of 8

HYDERABAD

Laps in wire mesh reinforcements shall not be measured. Reinforcing mesh shall be measured on actual area basis. Reinforcing bare shall be measured by weight.

The weight shall be arrived at on the basis sectional weights as per I.S. No extra shall be paid for necessary modifications of existing dowels, if any, to tie up with the Contractor's work.

**4.3.9 EXPOSED STONE WORK**

Exposed stone work using selected stone for exposed face shall be measured in area as an extra over ordinary stone work if as provided in the Schedule of Items.

Deductions shall be made as described in Clause 4.3.2.

**4.3.10 COMPOSITE MASONRY**

Composite masonry shall be measured for vale including backing if so provided in the Schedule of taxes. If not, brickwork and stone-work shall be measured separately and paid under relevant items.

**4.3.11 EXPANSION AND SEPARATION JOINTS**

Joints shall be measured for length or area for the complete work as shown on drawings including filler boards, sealant strips, sealing compounds, painting, cover etc. If so provided in the Schedule of items unless any particular work is specifically excluded from the item.

**4.3.12 MOULDING, CORNICE, DRIP COURSE:**

Mouldings, cornice, drip course unless indicated specifically under separate items shall be considered in masonry items. However, cut in bricks or stone shall be neglected in measurements.

**4.3.13 EMBEDDED FIXTURES**

Inserts etc shall be measured by weight or by number and paid separately under relevant item is the Schedule of Items.

**4.4.0 DAMP PROOFING:**

Damp proofing shall be measured and paid in net area. No deductions shall however be made for opening less than 0.1sq.m in area. No separated payment shall be made for preparation of base, formworks and additive for cast-in-situ damp proofing unless specified otherwise.

**5.0.0 I.S.CODES**



**STANDARD TECHNICAL  
SPECIFICATION FOR MASONRY  
AND ALLIED WORKS**

PEDC/STD.SPEC/12  
REV 00

Page 8 of 8

HYDERABAD

Some of the important relevant codes these sections are:-

- IS:1127 : Recommendations for dimensions and workman ship of natural building stones for masonry work
- IS:1597 : Code of practice for construction of Stone Masonry.
- IS:1609 : Code of practice for laying Damp-proof treatment using bitumen felts.
- IS:2212 : Code of practice for Brickwork.
- IS:2250 : Code of practice for preparation and use of Masonry Mortar.
- IS: 5134 : Bitumen Impregnated paper & Board.



**STANDARD TECHNICAL  
SPECIFICATION FOR FINISH TO  
MASONRY AND CONCRETE**

PEDC/STD.SPEC/0  
13/ REV 00

Page 1 of 7

HYDERABAD

**FINISH TO MASONRY AND CONCRETE**

REV. NO.	PRAPARED	APPROVED	DATE

**COPYRIGHT AND CONFIDENTIAL**

The information on this document is the property of BHARAT HEVY ELECTRICAL LTD.It must not be used directly or indirectly in any way detrimental to the interest of the Company.



# STANDARD TECHNICAL SPECIFICATION FOR FINISH TO MASONRY AND CONCRETE

PEDC/STD.SPEC/0  
13/ REV 00

Page 2 of 7

HYDERABAD

## 1.0.0 SCOPE

The Specification covers furnishing, installation, repairing, finishing, curing, testing, protection, maintenance till handing over or finishing items for masonry and concrete. This shall also include the work to be done to make the surface suitable for receiving the finishing treatment.

Before commencing finishing items the Contractor shall obtain the approval of the Engineer regarding the scheduling of work to minimise damage by other trades. He shall also undertake normal precaution to prevent damage or disfiguration to work of other trades or other installation.

## 2.0.0 INSTALATION

### 2.1.0 PREPARATION OF SURFACE

All joints masonry walls shall be racked out to a depth of 10mm with a hooked tool made for the purpose while the mortar is still green. Walls shall be brushed down with stiff wire brush to remove all loose dust from joints and thoroughly washed with water. All latency shall be removed from concrete to be plastered.

For all types of flooring, skirting and dado work, the base cement concrete slab or masonry surface shall be roughened by chipping and cleaned of all dirt, grease or loose particles by hard brush and water from the base course. Any excess of water shall be mopped up.

At any point, the level of base shall be lower than the theoretical finished floor level by the thickness of floor finish. Any chipping or filling to be done to bring the base in the required level shall be brought to the notice of the Engineer and his approval shall be taken regarding the method and extent of rectification work required.

Prior to commencement of actual finishing work, the approval of the Engineer shall be taken as to the acceptability of the base.

### 2.2.0 PLASTERING

#### 2.2.1 MORTAR

Mortar for plastering shall be as specified in the Schedule of Items.

For sand cement plaster, sand and cement in the specified proportion shall be mixed dry on a watertight platform and minimum water added to achieve working consistency.



## STANDARD TECHNICAL SPECIFICATION FOR FINISH TO MASONRY AND CONCRETE

PEDC/STD.SPEC/0  
13/ REV 00

Page 3 of 7

HYDERABAD

For lime gauged plaster, lime putty or hydrated lime and sand in the required proportion shall be mixed platform with necessary addition of the water and thoroughly ground in mortar mill. This mix shall then be transferred to a mechanical mixer to which the required quantity of cement is added and mixed for at least 3 minutes.

No plaster which has stood for more than half an hour shall be used; plaster than shows tendency to become dry before this time, shall have become dry before this time, shall have water added to it.

### 2.2.2 APPLICATION OF PLASTER

Plaster, when more than 12mm thick, shall be applied in two coats a base coat followed by the finishing coat. Thickness of the base coat shall be sufficient to fill up all unevenness in the surface, no single coat, however, shall exceed 12mm in thickness. The lower coat shall be thicker than the upper coat, the over all thickness of the coats shall not be less than the minimum thickness shown on the drawings. The undercoat shall be allowed to dry and shrink before applying the second coat at plaster. The undercoat shall be scratched or roughened before Applying the second coat at plaster. The undercoat shall be scratched or roughened before it is fully hardened to from a mechanical key. The method of application shall be thrown on rather than 'applied by trowel'.

To ensure even thickness and true surface, patches of plaster about 10 mm to 150mm square or wooden screen 75mm wide and of the thickness of the plaster, shall be fixed vertically about 2000mm to 3000mm apart, to act as gauges. The finished wall surface shall be true to plumb, and the Contractor shall, without any extra cost to the Owner, make up any irregularity in the brickwork with plaster.

All vertical edges of brick pillars, doorjambs etc., shall be chamfered or rounded off as directed by the Engineer. All drips, grooves, mol dings and cornices as shown on drawing or instructed by the Engineer shall be done with special care to maintain true lines, levels and profiles. After the plastering work is completed, all debris shall be removed and the area left clean. Any plastering that is damaged shall be repaired and left in good condition at the completion of the job.

### 2.2.3 FINISH

Generally, the standard finish shall be used unless otherwise shown on drawing or directed by the Engineer. Where ever, any special treatment to the plastered surface is indicated, the work shall be done exactly as shown on the drawings, to the entire satisfaction of the Engineer regarding the texture, colour and finish.

#### a) Standard Finish

Where punning is indicated, the interior plaster shall be finished rough. Otherwise, the interior plaster shall generally be finished to a smooth surface. The exterior surface shall generally be finished with a wooden float.



## STANDARD TECHNICAL SPECIFICATION FOR FINISH TO MASONRY AND CONCRETE

PEDC/STD.SPEC/0  
13/ REV 00

Page 4 of 7

HYDERABAD

b) **Neat cement finish**

Immediately after achieving a true plastered surface with the help of a wooden straight edges, the entire area shall be uniformly treated with a paste of neat cement at the rate of one (1)kg. Per Sq.M. and rubbed smooth with a trowel.

c) **Coloured plaster Finish**

This shall be done in the same way as specified in Clause 2:2:2 but using coloured cement in place of ordinary cement. When coloured plastering is specified in more one coat, the top coat shall be made with coloured cement. Colored cement shall be either ready mixed material or may be obtained by mixing pigments and cement at site, as approved by the Engineer. The pigments to be mixed with cement shall conform to Appendix – A of IS : 2114 latest edition

Samples of colouring material shall be submitted to the Engineer for approval and material produced, shall conform in all respects to the approved samples, Which shall remain with the Engineer. All coloured cement and/ or pigments Shall be stored in an approved manner on order to prevent deteriorations.

d) **Pebble-dash Finish**

Mortar of required thickness consisting of 1 part cement and 4 parts sand by volume shall be applied in the usual manner as described under plastering Clause 2.2.2. While the mortar is still plastic small pebbles or crushed stone of size generally from 10mm to 20 mm as approved by the Engineer shall be thrown on the plastered surface. The aggregate shall be lightly tapped into the mortar with a wood float end of a trowel, in order to ensure satisfactory bond between the dashing and the mortar.

e) **Rough-Cast Finish**

A wet plastic mix of 3 parts coloured cement 6 parts sand and 4 parts aggregate by volume (gravel or crushed stone of size from 6mm to 12mm as approved by the Engineer) shall be thrown on to the wall by means of a plaster's trowel and left in the rough condition.

f) **Scraped Finish**

Ordinary plaster as described under Clause 2.2.2 after being levelled and allowed to stiffen for a few hours, shall be scraped with a steel straight edges to remove the surface skin. The Patten shall be as approved by the Engineer.

g) **Textured Finish**

Mortar consisting of 1 part cement and 3 parts sand by volume shall be applied in a manner as specified under "Plastering" Clause 2.2.2 Ornamental requirements in the form of horizontal or vertical rib texture fan texture etc. shall be applied by means of suitable tools to the freshly applied plastered surface, as approved by the Engineer.

### 2.2.4 CURING



## STANDARD TECHNICAL SPECIFICATION FOR FINISH TO MASONRY AND CONCRETE

PEDC/STD.SPEC/0  
13/ REV 00

Page 5 of 7

HYDERABAD

All plastered surface after laying, shall be watered, for all minimum period of seven days, by an approved method, and shall be protected from excessive heat and sunlight by suitable approved means. Moistening shall commence, as soon as the plaster has hardened sufficiently and not susceptible to damage, Each individual coat of plaster shall be kept damp continuously, for at least two days, and then dried thoroughly, before applying the next coat.

### 2.3.0 POINTING TO MASONRY

All joints of brick shall be raked out to a depth of 10mm with a hooked tool made for the purpose while the mortar is still green. The brickwork shall then be brushed down with a stiff wire brush, so as remove all loose from the joints and thoroughly washed with water. Mortar consisting of 1 part cement and 3 parts clean, sharp, well graded sand by volume shall be pressed carefully into the joints and finishes with suitable tools to shape as shown on the drawings. Any surplus mortar shall be scraped off the wall face lagging the surface clean.

The pointed surface shall be kept wet for at least three days for curing.

### 2.4.0 PLASTER WITH METAL LATH

The supports, hangers, brackets, cleats etc., shall be as shown on drawings and/or approved by the Engineer. These shall have a coat of prime paint before and another coat of approved paint after erection.

The metal lath shall be expanded metal, with 12mm x 38mm mesh, 16 BC thick and 3 mm wide strands. Side laps shall be minimum 12mm and end laps 25mm minimum. The plastering shall be minimum 20mm thick measured from the back of lath and applied in two layers. The mortar for plastering shall consist of 1 part cement, ½ part lime and 4 parts sand by volume mixed as specified in plastering, Clause 2.2.1. The application, finish etc., shall be as specified under relevant clause above. Where called for in the Schedule of Items, a 2mm Plaster of Pair punning shall be applied over plaster as a finishing coat to give perfectly smooth and even finish

### 2.5.0 LIME PUNNING

For plastered surfaces, where an even smooth surface is specified, lime punning with 5 parts of shell lime properly slacked, strained and aged, mixed with 1 part clean, washed, sleeved, fine sand by volume shall be done. The thickness of lime punning shall be not less than 2mm and more than 3mm. The plastered surface shall be saturated with water before application of the lime punning. The punning shall be applied by skilled workman and given a smooth and even finish free from undulations, cracks etc. and to the satisfaction of the Engineer.

### 2.6.0 PLASTER OF PAIRS PUNNING

Plastered surfaces, where specified shall be finished with plaster of parts punning. The material shall be from approved manufactures and approved by



## STANDARD TECHNICAL SPECIFICATION FOR FINISH TO MASONRY AND CONCRETE

PEDC/STD.SPEC/0  
13/ REV 00

Page 6 of 7

HYDERABAD

The Engineer. The thickness of the punning shall be 2mm and shall be applied by skilled workmen. The finish shall be smooth, even and free from undulation, cracks etc. Before bulk work is taken in hand, a sample of punning shall be done on roughly 10 Esq. area and approval of the span Engineer taken. The work shall then be taken in hand as per approved sample.

### 2.7.0 STONE FANCING

Stone facing where specified shall be done as shown on design drawings and approved shop drawings. The stone shall be as specified on drawings and/or schedule of items. Samples of stone shall be submitted to the Engineer for approval and then bulk purchase made. The Contractor shall submit three copies of shop drawing for the Engineer's approval before commencing the work.

The thickness of facing stone shall be not less than 25mm unless otherwise specified on drawings.

The stone slabs shall be cut and finished to sizes as per pattern shown on drawings. They shall be fastened to wall with suitable non corrodible anchorage as approved by the Engineer. Where mild steel clamps, stays etc., are used for anchorage, they shall be galvanized (weight of zinc coating shall not be less than 700gms per square meter of surface) to prevent rust stains developing on the finished surface. There shall be at least 12mm gap between the stone and masonry, which shall be filled up and packed by a mortar of 1 part cement and 3 parts of sand by volume. After the mortar to set and cured for at least four days, the exposed surface shall be rubbed and polished as approved by the Engineer.

The completed surface shall be neat, or uniform texture and acceptable to the Engineer.

Where pointing is specified on drawings it shall be done by mortar as specified on drawings and/or Schedule of items.

### 3.0.0 ACCEPTANCE CRITERIA

Finish to masonry and concrete shall fully comply with the Specifications, approved samples and instructions of the Engineer with respect to lines, levels, thickness, colour, texture, pattern and any other special criteria as mentioned in the body of the specifications or as shown on drawings.

### 4.0.0 RATES

Rates shall be for the complete work as detailed out in the specification unless any particular portion is specifically excluded in the Schedule of Items. Rate shall include for rounding of corners.

### 5.0.0 METHOD OF MEASUREMENT



**STANDARD TECHNICAL  
SPECIFICATION FOR FINISH TO  
MASONRY AND CONCRETE**

PEDC/STD.SPEC/0  
13/ REV 00

Page 7 of 7

HYDERABAD

- a) All surface finish shall be measured on actual area laid. No deductions shall be made for openings, pipes, sleeves etc. upto 0.1 Sq.m in area.
- b) Unless separate item is provided for special corner or edges finish, drip course, grooves, mouldings, curbs etc., these shall not be measured separately. Where separate item is provided in the Schedule of Items, such work shall be measured for length.
- c) No separate payment shall be made for finishing round openings, sleeves, pipes, etc. No separate payment shall be made for form work, templates etc., required for achieving true lines and profiles as shown on drawing.
- d) Finishes applied integrally with walls, floors, steps and ceilings shall be measured separately and paid under relevant items.
- e) Any reinforcement incorporated in the finish shall be measured and paid separately under relevant items.
- f) Unless otherwise mentioned in the Schedule of Items, hangers, supports and lath plastering shall be measured and paid separately under relevant items.

**6.0.0 I.S. CODE**

Important relevant code for this Section:-

- a)IS:1661 : Code of practice for cement and Cement-lime plaster finish on walls & ceilings.
- b)IS:4101 : Code of practice for external facings and veneers.



**STANDARD TECHNICAL  
SPECIFICATION FOR PAINTING,  
WHITEWASHING, POLISHING ETC.**

PEDC/STD.SPEC/  
14- REV 00

Page 1 of 11

**HYDERABAD**

**PAINTING, WHITEWASHING, POLISHING ETC.**

REV. NO.	PRAPARED	APPROVED	DATE

**COPYRIGHT AND CONFIDENTIAL**

The information on this document is the property of BHARAT HEVY ELECTRICAL LTD.It must not be used directly or indirectly in any way detrimental to the interest of the Company.



## STANDARD TECHNICAL SPECIFICATION FOR PAINTING, WHITEWASHING, POLISHING ETC.

PEDC/STD.SPEC/  
14- REV 00

Page 2 of 11

HYDERABAD

### 1.0.0 SCOPE

This specification covers painting, white washing, varnishing polishing etc. of both interior and exterior surface of wood work, masonry, concrete plastering, plaster of pairs., false ceiling, structural and other miscellaneous steel items, rainwater down comer, floor and roof drains, soil, waste and service water pipes, and other ferrous and non-ferrous metal items as shown on drawings, schedule or as directed by the Engineer.

Copper, bronze, chromium plate, nickel, stainless steel, aluminium and monel metal shall generally not be painted or finished except if otherwise specified.

The painting Contractor shall inspect the work of other prior to the application of paint. If surface to be finished can not be put in suitable condition for painting by customary preparatory methods, the painting contractor shall notify the Engineer in writing or assume responsibility for and rectify unsatisfactory finishing that results.

Before commencing painting, the painting Contractor shall obtain the approval of the Engineer in writing regarding the schedule of work to minimize damage, disfiguration or staining by other trades. He shall also undertake normal precautions to prevent damage, disfiguration or staining to work of other or other installations.

### 2.0.0 INSTALLATION

#### 2.0.1 MATERIALS

Materials shall be highest grade products or well-known approved manufacture and shall be delivered to the site in original sealed containers, bearing brand name, manufacturer's name and colour shade, with labels intact and seals unbroken. All materials shall be subject to inspection, analysis and approved by the Engineer. It is desired that materials of one manufacturer only shall be used as far as possible and paint or one shade is obtained from the same manufacturing batch. All paint shall be subject to analysis from random samples taken at site from painters bucket, if so desired by the Engineer.

All prime coats shall be compatible to the material of the surface to be finished as well as to the finishing coats to be applied.

All unspecified materials such as shellac, turpentine or linseed oil shall be of the highest quality available and shall conform to the latest IS standards. All such materials shall be made by reputable recognised manufactures and shall be approved by the Engineer.

All colours shall be as per painting schedule and tinting and matching shall be done to the satisfaction of the Engineer. In such cases, where samples are



**STANDARD TECHNICAL  
SPECIFICATION FOR PAINTING,  
WHITEWASHING, POLISHING ETC.**

PEDC/STD.SPEC/  
14- REV 00

Page 3 of 11

HYDERABAD

required, they shall be executed in advance with the specified materials for the approval of the Engineer.

a) **White Washing**

Shall be done from pure shell lime or fat lime, or fat lime, or a mixture of both as instructed by the Engineer, and shall conform to IS : 712 latest edition. Samples of lime shall be submitted to the Engineer for approval, and lime as per approved sample shall be brought to site in unlaced condition. After slaking, it shall be allowed to remain in a tank of water for two days and then stirred up with a pole. Until it attains the consistency of thin cream. 100 grams of gum to 6 liters of white wash water and a little quantity of indite of synthetic ultramarine blue shall be added to the lime.

b) **Dry distemper**

Shall be made from suitable pigments, extenders, lime proof tinters, water soluble binders etc., and shall conform to IS:427.

c) **Oil Bound Washable Distemper**

Shall be of oil emulsion type, containing suitable preservatives and shall conform to IS:428.

d) **Waterproof Cement Paint**

Shall be made from best quality white cement and lime resistant colours with accelerators, waterproofing agent and fungicides. The paint shall conform to IS:5410.

e) **Acrylic Emulsion on Paint**

Shall be water-bases acrylic copolymer emulsion with rutile titanium dioxide and other selected pigments and fungicide. It shall exhibit excellent adhesion to plaster and cement surface and shall resist deterioration by alkali salts. The paint film shall allow the moisture in wall to be able to withstand washing with mild and water without any deterioration in colour, or without showing flaking, blistering or pooling.

f) **Synthetic Enamel Paint**

Shall be made from synthetic resins and drying oil with rutile titanium dioxide and other selected pigments to give a smooth, hard, durable and glossy finish to all exterior and interior surfaces. White and pastel shades shall resist yellowing and darkening with aging. The painting shall conform to IS:2932 and IS:2933

g) **Aluminium paint**

Shall be in two pack containers and shall resist weathering. The paint shall conform to IS: 2339.

h) Shall be best quilt alkyd varnish suitable for brushing over the tint of paint or



**STANDARD TECHNICAL  
SPECIFICATION FOR PAINTING,  
WHITEWASHING, POLISHING ETC.**

PEDC/STD.SPEC/  
14- REV 00

Page 4 of 11

HYDERABAD

Light natural wood and shall not darken or yellow with age.

**i) French Polish**

Shall be made from best quality shellac, denatured spirit and other suitable alcohol soluble ingredients and made by a well known approved manufacturer. The material shall conform to IS:348.

French polish shall not be used on bare wood. It shall only be used as finishing coat on wood after the wood is pre-treated with a liquid wood filler conforming to IS : 345 is applied and rubbed out.

**2.0.2 STORAGE**

The Contractor shall arrange for safe and proper storage of all materials and tools. The storage space if allotted within the building shall be adequately protected damage, disfigurement stains. Paint shall be kept covered at all times and mixing shall be done in suitable containers. All necessary precautions shall be taken by the Contractor to prevent fire.

**2.1.1 PREPARATION OF SURFACE**

Before starting the work the Contractor shall obtain the approval of the Engineer regarding the soundness & readiness of the surface to be painted on.

**2.1.1 WOOD**

All surface shall be free from dirt and loose or peeling paints. The surface shall be rubbed down smooth. All nails & screws shall be sunk below the surface and filled with putty after applying an under coat. Small knots that do not justify cutting and sap streaks shall be covered with minimum 2 coats of pure shellacs applied thinly & extended 25mm beyond the area. All large, loose or resinous knots shall be removed and filled with sound wood. All work shall be done as per IS :2338.

**2.1.2 MASONRY, CONCRETE AND PLASTERED SURFACE**

Surface shall be from all oil, grease, efflorescence, mildew, loose pair or other foreign and loose materials. Masonry cracks shall be cleaned out and patch filled With mortar similar to the original surface and uniformly textured. Where this type of resurfacing may lead to the finishing paint being different in shade from the original surfaces, the resurfaces area shall be treated from the original surfaces, the resurfaces area shall be treated with minimum one coat of cement primer which should be continued to the surrounding area for a distance of minimum 100mm.

Surface with mildew or efflorescence shall be treated as below.



## STANDARD TECHNICAL SPECIFICATION FOR PAINTING, WHITEWASHING, POLISHING ETC.

PEDC/STD.SPEC/  
14- REV 00

Page 5 of 11

HYDERABAD

### a) **Mildew**

All mildew surface shall be treated with an approved fungicide such as ammonia cal wash consisting of 7g of copper carbonate dissolved in 80ml liquor ammonia and diluted to 1 litre with water, or 2,5 percent magnesium silica fluoride solution and allowed to dry thoroughly before paint is applied.

### 2.1.3 **METAL**

All metal surface shall be absolutely clean, dry and free from wax, grease or dried soap films. In addition, all steel and iron surface shall be free from rust, surface shall be cleaned by mechanical power tools to remove mill scales unless otherwise approved by the Engineer for epoxy chemical resistant paints, surface shall be blast cleaned to near white metal. All galvanised iron surfaces shall be pre-treated with a compatible primer according to the manufacturer's direction. Any abrasion in shop coat shall be touched up with the same quality of paint as the original cost.

### 2.1.0 **APPLICATION**

#### 2.2.1 **GENERAL**

The method of application shall be as recommended by the manufacturer. In case of selection of special shade and colour (not available in standard shades) the Contractor shall mix different shades and prepare test panels of minimum size 1 meter square as per instruction of the Engineer and obtain his approval prior to application of finishing paints.

Proper tools and implements shall be used. Scaffolding if used shall be independent of the surface to be painted to avoid shade differences of the freshly repaired anchor holes.

Painting shall be done by skilled labours in a workman like manner. All materials shall be evenly applied so as to be free of sags, runs, crawls or other defects. All coats shall be of proper consistency. In case of application by brush, no brush marks shall be visible. The brushes shall be clean and in good condition before application of paint.

All priming undercoats for painting shall be applied by brush only, and rollers spray equipments etc., shall not be used.

No work shall be done under condition that are unsuitable for production of good results. No painting shall be done when plastering is in progress or is drying. Application of paint which seals the surface to moisture shall only be done after the moisture on the below the surface has dried out.



## STANDARD TECHNICAL SPECIFICATION FOR PAINTING, WHITEWASHING, POLISHING ETC.

PEDC/STD.SPEC/  
14- REV 00

Page 6 of 11

HYDERABAD

All coats shall be thoroughly dry before succeeding is applied. Coats of painting as specified are intended to cover surface perfectly. In case the surface is not covered properly by applying the specified number of coats, further cats shall be applied by the Contractor when so desired by the Engineer.

sample and all finish shall be uniform in colour and texture. All parts of mouldings and ornaments shall be left clean and true to finish.

Painting on ferrous metal surface shall be done as per IS:1477 (part 1&2). The total dry thickness of the film should not be less than 120 micron.

### 2.2.2 WHITE WASHING

The surface where white washing is to be applied shall be cleared of all loose materials and dirt. All holes and irregularities of the surface shall be filled up with lime putty and shall be allowed to dry up before application of the lime solution.

One coat of white wash shall consist of one stroke from top downwards, another from bottom upwards over the first stroke and another from left to right before the previous one dries up. Second coat shall be applied in case the Engineer feels that one more coals are required the Contractor shall do so without any extra coat to the owner. No brush marks shall show on the finished surface.

### 2.2.3 DRY DISTEMPER

New plastered surface shall be allowed to dry for at least two months. New lime or lime cement plastered surface shall be washed with a solution of 1 part vinegar to 12 parts water of 1:50 sulphuric acid solution and 24hours after which the wall shall be thoroughly washed with clean water. For cement plastered surface, the surface shall be washed with a solution of 100gms of zinc sulphate to 1 litre of water then allowed to dry.

Dry distemping shall be done as per manufacture's instruction. In applying the distempers the brush should first be applied horizontally and immediately crossed off perpendicularly. Brushing shall not be continued too long, as otherwise brush marks may result.

### 2.2.4 OIL HOUND WASHBLE DISTEMPER

The distemper shall be applied after surface is printed with an alkali resistant primer, and followed by minimum two coats of oil bound washable distemper all as per manufacture's instruction.

### 2.2.5 WATERPROOF CEMENT'S PAINT



**STANDARD TECHNICAL  
SPECIFICATION FOR PAINTING,  
WHITEWASHING, POLISHING ETC.**

PEDC/STD.SPEC/  
14- REV 00

Page 7 of 11

HYDERABAD

Surface to be coated with cement paint shall be washed and brushed down. As soon as the moisture has disappeared, the surface shall be given one coat of paint. Care shall be taken so that the paint does not dry out too rapidly. After 4 to 6 hours, the water shall be sprinkled over the surface to assist curing and prevent cracking. After the first coat has dried (24 to 48 hours) the second coat shall be applied in a similar manner. The finished surface shall be kept moist by occasional sprinkling with water for seven days after painting.

**2.2.6 ACRYLIC EMISSION PAINT**

Lime gauged cement plastered surfaces shall not be painted for at least one month after plastering. A sample patch shall be painted to check alkali reaction if so desired by the engineer. Painting shall be strictly as per manufacturer's specification.

**2.2.7 SYNTHETIC ENAMEL PAINT**

Shall be applied on properly primed surface. Sub sequential coat shall not be applied till the previous coat is dry. The previous shall be lightly sand papered for better adhesion of subsequent coat.

**2.2.8 ALUMINIUM PAINT**

The paint, supplied in two pack containers shall be mixed and applied strictly as per manufacturer's direction. When more than one coat of paint is required or indicated, the next coat shall only be applied after the previous coat becomes hard dry.

**2.2.9 CLEAR SYNTHETIC VARNISH**

The varnish shall be applied on wood surface after (a) staining & (c) Sealing operations are carried out. The application of a combination of filler and stain shall not be permitted.

For the finishing coats of varnish, the surface shall be allowed to dry and rubbed down lightly, wiped off and allowed to dry. Careful attention to cleanliness is required for varnishing. All dust and dirt shall be removed from the surface as well as from the neighbourhood. Damp atmosphere and draughts shall be avoided, and exposure to extreme heat or cold & dampness shall not be allowed.

The varnish shall be applied liberally with a brush and spread evenly over a portion of the surface with light strokes to avoid frothing. It shall be allowed to flow on while the next section is being laid on excess varnish shall then be scrapped off the brush and the first section be crossed, recrossed and then laid off lightly. The varnish once it has begun to set, shall not be retouched. In case of any mistake in application, the varnish shall be removed and the work started afresh.



## STANDARD TECHNICAL SPECIFICATION FOR PAINTING, WHITEWASHING, POLISHING ETC.

PEDC/STD.SPEC/  
14- REV 00

Page 8 of 11

HYDERABAD

The varnish shall be minimum of two coats, with the first coat being a flattening varnish. This shall be allowed to dry hard and be flattened down, before applying the next coat. Sufficient time must be allowed between coats to get a hard dry surface before next coat is applied. All work shall be as per relevant IS Code.

### 2.2.10 FRESH POLISH

All unevenness of the surface shall be rubbed down to smoothness with sand paper and the surface shall well dusted. The pores in the wood shall be filled up with a paste of whitening in water or methylated spirit with a suitable pigment like burnt sienna or umber.

After application of the filler paste, the French polish shall be applied with a pad of woollen cloth covered by a fine cloth. The pad shall be moistened with polish and rubbed hard on the surface in a series of overlapping circles so that the polish is sparingly but uniformly applied over the entire area to give an even surface. A trace of linseed oil may be used on the pad for ease of application. A trace of linseed oil may be used on pad for ease of application. The surface shall be allowed to dry before further coats are applied in the same manner. To finish off, the pad shall be covered with a fresh piece of clean fine cloths, slightly dampened with methylated spirit and rubbed lightly and quickly with circular motions to leave the finished surface with a uniform texture and high gloss.

### 2.2.11 CHEMICAL RESISTANT PAINT

For chemical resistant paints, epoxy, chlorinated rubber or vinyl butryl paint system shall be used manufacture's recommendation regarding the paint system Exposed to moderately severe corrosive condition and subject to acid/alkali spillage and fumes, shall be followed.

### 2.2.0 PROTECTION

Furniture and other movable objects, equipments, fittings and accessories shall be moved, protected and replaced upon completion of work. All stationary equipments shall be well covered so that no paint can fall on them. Work finished by other agencies shall be well protected. All protections shall be done as instructions of the Engineer.

### 2.3.0 CLEANING UP

In addition to provisions in general conditions the Contractor shall, upon completion of painting etc., remove all marks and make good surface, where paint has been spilled, splashed or spattered, including all equipments, fixtures, glass, furniture, fittings etc., to the satisfaction of the Engineer.



**STANDARD TECHNICAL  
SPECIFICATION FOR PAINTING,  
WHITEWASHING, POLISHING ETC.**

PEDC/STD.SPEC/  
14- REV 00

Page 9 of 11

**HYDERABAD**

**2.4.0 ACCEPTANCE CRITERIA**

- a) All painted surfaces shall be uniform and pleasing in appearance.
- b) All varnished surface surfaces shall be of uniform texture and high glossy finish.
- C) The colour, texture etc., shall match exactly with those of approved samples
- d) All stains, splashes and splatters of paints and varnishes shall be removed from surround surfaces.

**4.0 RATES**

Rates shall be unit rates for complete items described in the Schedule of Items. No extra payment will be made for preparation of surface before be made for preparation of surface before painting or for cleaning up after the work is complete.

**5.0 METHOD OF MEASUREMENT**

- a) Structural steel work shall not be measured separately and the cost shall be included in this rates for the fabrication and erection.
- b) Painting or whitewashing to concrete or masonry shall be measured and on the area painted. For measurement of openings whose jambs, sills, soffits etc., are to be painted the following procedure shall be followed.
  - I) For openings up to 0.5 Sq.M no deductions shall be made and no additions shall be made for lambs, sills, etc.,
  - ii) For opening exceeding 0.5 Sq.m. but not exceeding 3.0 Sq.m. each deductions shall be made for half the area of openings, and no additions shall be made for jambs sills etc.
  - iii) For opening exceeding 3.0Sq.m. each deductions shall be made for the jambs, sills, soffits, reveals etc.
- c) For opening, pipes, sleeves etc., whose sides are not finished no deductions shall be made openings etc., up to 0.1 Sq.m. in area each, and full deductions shall be made for all openings above 0.1 Sq.m. in area each.



**STANDARD TECHNICAL  
SPECIFICATION FOR PAINTING,  
WHITEWASHING, POLISHING ETC.**

PEDC/STD.SPEC/  
14- REV 00

Page 10 of 11

HYDERABAD

- d) No extra shall be paid for painting etc. done around openings, sleeves, pipes ducts, inserts etc.
- e) No extra payment shall be made for painting, etc., on wall features such as grooves, ducts, beads, protections, cornices, etc., unless give different finish or otherwise specified in the "Schedule of Items". The actual area of the features shall be gritted and included in the wall measurements.
- f) For painting of uneven surface in doors, windows, ventilators, louvers, guard bars, balustrades, gratings, railings, gates, etc., equivalent plain areas shall be measured as given in Clause 17.2 (Table 11) of IS:1200 unless mentioned otherwise.
- g) Corrugated surface shall be measured flat as fixed as not gritted. The quantities as measured shall be multiplied by the following factors to get equivalent plain area:
- i) Corrugated steel sheets-shall be multiplied by 1.14
  - ii) Corrugated asbestos sheet with large corrugations shall be multiplied by 1.20.
  - iii) Semi-corrugated asbestos cement sheets shall be multiplied by 1.10
  - iv) Any other non-standard for sanitary and plumbing work, no separate Measurement shall be made and the cost shall be included in the Installation of pipes.
- h) For painting pipes for sanitary and plumbing work, no separate measurement Shall be made and the cost shall be included in the installation of pipes.
- i) Unless specifically started on the schedule of items, all painting, varnishing or Polishing of wood shall be measured and paid on the area treated. For Measurement of uneven surfaces, equivalent Main area shall be measured as Per Clause 17.2 (Table ii) of IS: 1200 unless specified otherwise.

**6.0.0 I.S. CODE**

Important relevant IS Codes for this Sections are listed below:

IS:348 : Specification for French Polish

IS:427 : Specification for Distemper, dry colour as required .

IS:428 : Specification for distemper oil emulsion, colour as required.



**STANDARD TECHNICAL  
SPECIFICATION FOR PAINTING,  
WHITEWASHING, POLISHING ETC.**

PEDC/STD.SPEC/  
14- REV 00

Page 11 of 11

**HYDERABAD**

IS:1477(I&II) : Code of practice for painting of ferrous metal in buildings.

IS:2328(I&II) : Code of practice for finishing of wood and wood based materials.

IS:2329 : Specification for Aluminium paints for general purposes in dual containers.

IS:2395 : Code of practice for painting concrete masonry and plaster.

IS:2932 : Specification for enamel, synthetic, exterior, type-1.

IS:5410 : Specification for cement paint, colour as required.



HYDERABAD

**STANDARD TECHNICAL  
SPECIFICATION FOR FLOOR  
FINISHES AND ALLIED WORKS**

PEDC/STD.SPEC/15  
/ REV 00

Page 1 of 26

## FLOOR FINISHES AND ALLIED WORKS

REV. NO.	PRAPARED	APPROVED	DATE

**COPYRIGHT AND CONFIDENTIAL**

The information on this document is the property of BHARAT HEVY ELECTRICAL LTD.It must not be used directly or indirectly in any way detrimental to the interest of the Company.



HYDERABAD

**STANDARD TECHNICAL  
SPECIFICATION FOR FLOOR  
FINISHES AND ALLIED WORKS**

PEDC/STD.SPEC/15  
/ REV 00

Page 2 of 26

**1.0 SCOPE**

This specification covers furnishing, installation, finishing curing, testing, protection, maintenance till hanging over various type of floor finishes and allied item of work as listed below:

**a) In Situ Finishes**

- i) Integral Finish to concrete base
- ii) Red Oxide of Iron finish
- iii) Terrazzo finish
- iv) Granolithic finish
- v) Patent stone
- vi) Metallic Hardener like “Ironite” finish
- vii) Mastic Asphalt finish
- viii) Chemical Resistant finish

**b) Tiled finishes**

- i) Terrazzo tile
- ii) Chequered tile
- iii) Glazed tile
- iv) Tesserae (Mosaic etc.)
- v) Chemical Resistant
- vi) Rubber, Vinyl etc.
- vii) Stone Slab

**1.0.1 BASE**

The base to receive the finish is covered under other relevant specification.

**1.0.2 SEQUENCE**



HYDERABAD

## STANDARD TECHNICAL SPECIFICATION FOR FLOOR FINISHES AND ALLIED WORKS

PEDC/STD.SPEC/15  
/ REV 00

Page 3 of 26

Commencement, scheduling and sequence of the finishing works shall be planned in detail and must be specifically approved by the Engineer in view the activities of other agencies working in the area. However, the Contractor for the finishing items shall remain fully responsible for all normal precautions and vigilance to prevent any damage what so ever till handing over.

### 2.0 INSTALLATION

#### 2.0.1 SPECIAL MATERIALS

Basic materials are covered under Specification “properties Storage and Handling of Common Building Materials” Special materials required for individual finishing items are specified under respective items. In general, all such materials shall be as per relevant I.S. Codes where available. In all cases these materials Shall be of the best quality available indigenously, construction schedule.

The materials for finishing items must be procured from well reputed specialised manufacturers and on the basis of approval of samples by the Engineer. The materials shall be ordered, procured and stored well in advance to avoid compulsion to use substandard items to maintaining in the construction schedule.

#### 2.0.2 WORKMANSHIP

Only workers specially experienced in particular items of finishing work shall be engaged, where such workers are not readily available, with the Engineer’s permission, experienced supervisors recommended by the manufacture shall be engaged in particular cases where the Engineer so desires the Contractor shall get the finishing items install by the manufacture.

#### 2.0.3 PREPARATION OF THE BASE SURFACE

The surface to the treated shall be thoroughly examined by the contractor. Any rectification necessary shall be brought in the notice of the Engineer and his approval shall be taken regarding method and extent of such rectification work.

For all types of flooring, skirting, dado and similar locations, the base to receive the finish shall adequately roughened by chipping, taking out joints and cleaning thoroughly all dirt’s, grease etc., with water and hard brush and detergent if required, unless otherwise directed by the manufacturer of any special finishing materials or specifically indicated in this specification under individual item.

To prevent soakage of water from the finishing treatment the base shall be thoroughly soaked with water and all excess water mopped up. The surface shall be done dry where adhesives are used for fixing the finishes.

Prior to Contractor Commencement of actual finishing work the approval of the Engineer shall be taken as per the acceptability of the surface.



HYDERABAD

**STANDARD TECHNICAL  
SPECIFICATION FOR FLOOR  
FINISHES AND ALLIED WORKS**

PEDC/STD.SPEC/15  
/ REV 00

Page 4 of 26

**2.1 IN SITU FINISHES**

**2.1.1 INTEGRAL FINISH TO CONCRETE BASE**

While the surface of the concrete laid as per specification for Cement Concrete has been fully compacted and levelled but the concrete is still 'green' a thick slurry made with neat cement shall be applied evenly and worked in with iron float. When the slurry starts to set it shall be pressed with iron floats to have a firm compact smooth surface without trowel mark of undulations. This finish shall be as thin as possible by using 2.2kg, of Cement per Sq.M.of area.

The surface shall be kept in shade for 24 hours and then cured for at least 7 days continuously by flooding with water. The surface shall not be subjected to any load or abrasion till 21 days after laying.

As desired by the Engineer the surface, while still 'green' shall be indicated by pressing strings, the marking shall be of even depth, in straight lines and the panels shall be of uniform and symmetrical patterns.

**2.1.2 RED OXIDE OF IRON FINISH**

It shall consist of an under bed and a topping over already laid and matured concrete base.

**a) Thickness**

Unless otherwise specified the total thickness of the finish shall be minimum 50 mm for horizontal and 25mm for vertical surface of which the topping shall (not less than 10mm) while the topping shall be of uniform thickness the under bed may vary in thickness to provide necessary slope. The vertical surface shall project out 6mm from the adjacent plaster or other finishes. Necessary cutting into the surface receiving the finish shall be done to accommodate the specified thickness.

All junctions of vertical with horizontals shall be rounded neatly to uniform radius of 25mm.

**b) Mix**

**i) Underbed**

The underbeds for floors and similar horizontal surface shall consist of a mix of 1 part cement, 2 parts coarse and 4 parts 10 mm down graded stone chips by volume. For vertical sand similar surface the mix shall consist of 1 part cement to 3 parts coarse sand by volume.



HYDERABAD

**STANDARD TECHNICAL  
SPECIFICATION FOR FLOOR  
FINISHES AND ALLIED WORKS**

PEDC/STD.SPEC/15  
/ REV 00

Page 5 of 26

**ii) Topping**

For the topping cement, screened through a fine mesh and red oxide of iron pigment powder similarly screened shall be dry mixed thoroughly in right proportions to produce the desired colour when laid. The mix shall then be prepared with 1 part cement (mixed with pigment) and 3 parts coarse volume. The whole quantity required for each visible area shall be prepared in one batch to ensure uniform colour.

**c) Laying**

The under bed shall be laid in panels of mixing area 5 Sq.M. each and no side shall be more than 2.5m long. For outdoor locations the maximum area shall be 2.0 Sq.M. The forms for the panels shall have perfectly aligned edges to the full depth of the total thickness of finish. If specified aluminium or glass dividing strips shall be used.

The panels shall be laid in alternate bays or in chequered board pattern. No panel shall be cast in contact with another already laid, until the contraction of the latter has taken place. The under bed shall be laid, compacted, levelled and brought to proper grade with a screed or float. The topping shall be placed after about 24 hours while the under bed is still somewhat 'green' but firm enough to receive the topping. The surface of the under bed shall be roughened for better bonding. The topping shall be rolled for horizontal stress and thrown and pressed for vertical areas to extract all superfluous cement  
And water to achieve a compact dense mass fully boned with the under bed.

The topping shall then be levelled up by trowel ling and finished smooth with a slurry made with already prepared cement and pigment mixture. About 2.0kg of the mixture shall be consumed/per Sq.M. for horizontal surface and 1.0 kg, for vertical surface. The surface shall be cured for seven days by keeping it moist.

**d) Polishing**

About 16 hours after laying when the surface has hardened sufficiently it shall be polished with polishing stone till a smooth shiny surface to the satisfaction of the Engineer, is achieved. The finish shall washed and cleaned just before handing over.

**2.1.3 TERRAZO FINISH: IN SITE**

It shall consist of an underbeds and a topping laid over an already laid and matured concrete base.

**a) Thickness**



HYDERABAD

**STANDARD TECHNICAL  
SPECIFICATION FOR FLOOR  
FINISHES AND ALLIED WORKS**

PEDC/STD.SPEC/15  
/ REV 00

Page 6 of 26

Unless, otherwise specified the total thickness of the finish be minimum 550mm for horizontal and 25mm for vertical surface of which the topping shall be not less than 10mm. While, the topping shall be of uniform thickness the under bed may vary in thickness to provide necessary slopes. The vertical surface shall project cut 6mm from the adjacent plaster or other finish. Necessary cutting into the surface receiving the finish shall be done to accommodate the specified thickness.

All

**b) Mix**

**i) Under bed**

The under bed for floors and similar horizontal surface shall consist of mix of 1 part cement, 1 ½ parts sand and 3 parts stone chips by volume. For vertical surface the mix shall consist of 1 part cement to 3 parts sand by volume. The sand shall be coarse. The stone chips shall be 10mm down well graded. Only sufficient water to be added to give a workable consistency.

**ii) Tapping**

The mix for the tapping shall be composed of cement colour pigment, marble chips. Proportions of the ingredients shall be such as to produce the terrazzo of colour texture and pattern approved by the Engineer. The cement shall be white or grey or a mixture of two to which pigment shall be added to achieve the desired colour. To 3 parts of this mixture 1 part marble powder by volume shall be added and thoroughly mixed dry. To 1 part of this mix 1 to 1 1/2 parts of marble chips by volume shall be added and thoroughly mixed dry again.

The pigment must be stable and non fading. It must be very finely ground. The marble powder shall be from white marble and shall be finer than IS Sieve No.:30. The size of marble chips may be between 1 mm to 20mm.

Sufficient quantity to cover each visible area shall be prepared in one lot to ensure uniform colour. Water to make it just workable shall be added to quantity that can be used up immediately before it starts to set.

**c) Laying**

The under bed shall be laid in panels. The panels shall not be more than 5 Sq.M. in area of which no side shall be more than 2.5 M long, for exposed location the maximum area of panel shall be 2.0 Sq.M. The panel shall be laid



HYDERABAD

**STANDARD TECHNICAL  
SPECIFICATION FOR FLOOR  
FINISHES AND ALLIED WORKS**

PEDC/STD.SPEC/15  
/ REV 00

Page 7 of 26

in alternate bays or chequered board pattern. No panel shall be cast in contact with another already laid until the latter has contracted to the full extent.

Dividing strips made of aluminium or glass shall be used for forming the panels. The strips shall exactly match the total depth of under bed plus topping.

After laying, the under bed shall be levelled compacted and brought to proper grade with a screed or float. The topping shall be laid after about 24 hours while the under bed is still somewhat 'green' but firm enough to receive the topping. A slurry of the mixture of cement and pigment already made shall be spread evenly and brushed in just before laying the topping. The topping shall be horizontal areas and thrown and pressed for vertical area to extract all superfluous cement and water and to achieve a compact dense mass fully bonded with the under bed. The surface of the topping shall be trowel led over, pressed and brought to a smooth dense surface showing a minimum 75% area covered by marble chips in an even pattern of distribution.

**d) Curing**

The surface shall be left for curing for about 12 to 18 hours and then cured by allowing water to stand on the surface or by covering with wet sack for four days.

**e) Grinding and polishing**

When the surface has sufficiently hardened it shall be watered and ground evenly with rapid cutting coarse grade (no. 40) grit blocks, till the marble chips are exposed and the surface is smooth. Then the surface shall be thoroughly washed and cleaned. A grout with already prepared mixture of cement and pigment shall be applied to fill up all pinholes. The surface shall be cured for 7 days by keeping in moist and then ground with fine grit blocks (no:120). It shall again be cleaned with water, the slurry applied again to full up any pinholes that might have appeared and allowed to be cured again for 5 days. Finally, the surface is ground a third time with very fine grit blocks (no:320) to get smooth surface without pinhole. The grinding shall be done by a suitable machine. Where grinding machine can not be used hand grinding may be allowed when the first rubbing shall be with carborundum stone of coarse grade (no:80) and final rubbing and polishing with fine grade (no:120). The surface shall be cleaned with water, dried and covered with solid free, clean sawdust if directed by the Engineer. The final polishing shall be positioned till before handing over the surface shall be dusted with oxalic acid at the rate of 0.33 gm. Per/Sq.M. water sprinkled on to it and finished by buffing with felt or Hessian bobs. The floor shall be cleaned with soft moist rag and dried. However, all excess wax polish to be wiped if and the surface to be left glossy but not slippery.

**2.1.4 GRANOLITHIC FINISH**



HYDERABAD

**STANDARD TECHNICAL  
SPECIFICATION FOR FLOOR  
FINISHES AND ALLIED WORKS**

PEDC/STD.SPEC/15  
/ REV 00

Page 8 of 26

Granolithic finish shall either be laid monolithically over base concrete or separately over hardened base concrete.

a) **Thickness**

The finish shall be average 20 mm and minimum 12 mm thick, unless specified otherwise.

b) **Mix**

The mix shall consist of 1 part cement: 1 part coarse sand 2 parts coarse aggregate by volume. The coarse aggregate shall be very hard like granite and well graded between 6mm and 12mm. Minimum quantity of water to get workability shall be added.

c) **Laying of Monolithic Topping**

The concrete base shall be laid as per specification “cement concrete” and levelled up to the required grade. The form shall remain sufficiently protruding to take the finish.

Within about 3 hours of laying the base while it is still fully “green” the topping shall be laid evenly to proper thickness and grade. If considered necessary the surface of the base shall be roughened by the Engineer, mechanical vibrators of suitable design shall be used to press the topping firmly and work vigorously and quickly to secure full bond with concrete base.

The latency brought to the surface during compression shall be removed carefully without disturbing the stone chips. The surface shall then be lightly trowelled to remove all marks. When sufficiently set, hand trowelling shall be done to secure a smooth surface without disturbing the stone chips.

For large areas the laying shall be in panels of maximum 16 Sq.M. area. The panels shall be laid in chequered board pattern.

d) **Laying of Topping Separately on Hardened Base**

The base concrete shall be prepared as stated in clause 2.0.3 and a slurry of neat cement applied just prior to laying the Granolithic concrete mix (1:1:2). The method of compaction etc., shall be same as monolithic topping.

e) **Curing**

Immediately after laying, the finish shall be protected against rapid drying. As soon as the surface has hardened sufficiently, it shall be kept continuously moist for at least 10 days by means of wet gunny bags or pouring of water on the surface. The floor shall not be exposed to heavy traffic during this period.



HYDERABAD

**STANDARD TECHNICAL  
SPECIFICATION FOR FLOOR  
FINISHES AND ALLIED WORKS**

PEDC/STD.SPEC/15  
/ REV 00

Page 9 of 26

**f) Grinding**

If grinding is specified, it shall start only after the finish has fully set, Clause 2.1.3 © shall be followed. However, the ultimate polish required shall be decided upon by the Engineer.

**g) Finishing**

Where specified, sodium silicate or magnesium or zinc silica fluoride treatment shall be done. The number of coats to be applied shall be as specified in the Schedule of items. The concentration and method of application of the solutions shall be as specified in IS:5481.

**2.1.5 PATENT STONE**

It shall consist of an under bed and a topping laid on an already laid and matured concrete base.

**a) Thickness**

The patent stone finish shall have thickness as stipulated under clause 2.1.2(a) except that the topping shall be 6mm thick.

**b) Mix**

**i) Under bed**

The mix shall be as stipulated under clause 2.1.3 (b)

**ii) Topping**

The mix for the topping shall consist of 1 part cement and 1 part fine sand by volume.

**c) Laying**

The Patent Stone finish, including the under bed shall be laid in alternate bays or in chequered board pattern. No panel shall be in contact with another already laid till the concentration of the latter has already taken place.

The maximum area of each panel shall be 3 SQ.M. of which no side shall be more than 2 M long.

Unless otherwise specified the total thickness of the finish shall be minimum 50 mm horizontal and 25mm for vertical surface of which the topping shall (not less



HYDERABAD

**STANDARD TECHNICAL  
SPECIFICATION FOR FLOOR  
FINISHES AND ALLIED WORKS**

PEDC/STD.SPEC/15  
/ REV 00

Page 10 of 26

than 10mm) while the topping shall be of uniform thickness the under bed may vary in thickness to provide necessary slope. The vertical surface shall project out 6mm from the adjacent plaster or other finishes. Necessary cutting into the surface receiving the finish shall be done to accommodate the specified thickness.

All junctions of vertical with horizontals shall be rounded neatly to uniform radius of 25mm.

e) **Mix**

- i) The underbeds for floors and similar horizontal surface shall consist of a mix of 1 part cement, 2 parts coarse and 4 parts 10 mm down graded stone chips by volume. For vertical sand similar surface the mix shall consist of 1 part cement to 3 parts coarse sand by volume.
- ii) For the topping cement, screened through a fine mesh and red oxide of iron pigment powder similarly screened shall be dry mixed thoroughly in right proportions to produce the desired colour when laid. The mix shall then be prepared with 1 part cement (mixed with pigment) and 3 parts coarse volume. The whole quantity required for each visible area shall be prepared in one batch to ensure uniform colour.

f) **Laying**

The under bed shall be laid in panels of mixing area 5 Sq.M. each and no side shall be more than 2.5m long. For outdoor locations the maximum area shall be 2.0 Sq.M. The forms for the panels shall have perfectly aligned edges to the full depth of the total thickness of finish. If specified aluminium or glass dividing strips shall be used.

The panels shall be laid in alternate bays or in chequered board pattern. No panel shall be cast in contact with another already laid, until the contraction of the latter has taken place. The under bed shall be laid, compacted, levelled and brought to proper grade with a screed or float. The topping shall be placed after about 24 hours while the under bed is still somewhat 'green' but firm enough to receive the topping. The surface of the under bed shall be roughened for better bonding. The topping shall be rolled for horizontal stress and thrown and pressed for vertical areas to extract all superfluous cement

And water to achieve a compact dense mass fully boned with the under bed.

The topping shall then be levelled up by trowel ling and finished smooth with a slurry made with already prepared cement and pigment mixture. About 2.0kg of the mixture shall be consumed/per Sq.M. for horizontal surface and 1.0 kg, for vertical surface. The surface shall be cured for seven days by keeping it moist.

g) **Polishing**



HYDERABAD

**STANDARD TECHNICAL  
SPECIFICATION FOR FLOOR  
FINISHES AND ALLIED WORKS**

PEDC/STD.SPEC/15  
/ REV 00

Page 11 of 26

About 16 hours after laying when the surface has hardened sufficiently it shall be polished with polishing stone till a smooth shiny surface to the satisfaction of the Engineer, is achieved. The finish shall washed and cleaned just before handing over.

**2.1.6 TERROZO FINISH: IN SITE**

It shall consist of an underbeds and a topping laid over an already laid and matured concrete base.

**f) Thickness**

Unless, otherwise specified the total thickness of the finish be minimum 550mm for horizontal and 25mm for vertical surface of which the topping shall be not less than 10mm. While, the topping shall be of uniform thickness the under bed may vary in thickness to provide necessary slopes. The vertical surface shall project cut 6mm from the adjacent plaster or other finish. Necessary cutting into the surface receiving the finish shall be done to accommodate the specified thickness.

**g) Mix**

**i) Under bed**

The under bed for floors and similar horizontal surface shall consist of mix of 1 part cement, 1 ½ parts sand and 3 parts stone chips by volume. For vertical surface the mix shall consist of 1 part cement to 3 parts sand by volume. The sand shall be coarse. The stone chips shall be 10mm down well graded. Only sufficient water to be added to give a workable consistency.

**ii) Tapping**

The mix for the tapping shall be composed of cement colour pigment, marble chips. Proportions of the ingredients shall be such as to two produce the terrazzo of colour texture and pattern approved by the Engineer. The cement shall be white or grey or a mixture of two to which pigment shall be added to achieve the desired colour. To 3 parts of this mixture 1 part marble powder by volume shall be added and thoroughly mixed dry. To 1 part of this mix 1 to 1 1/2 parts of marble chips by volume shall be added and thoroughly mixed dry again.

The pigment must be stable and non fading. It must be very finely ground. The marble powder shall be from white marble and shall be finer than IS Sieve No.:30. The size of marble chips may be between 1 mm to 20mm.



HYDERABAD

**STANDARD TECHNICAL  
SPECIFICATION FOR FLOOR  
FINISHES AND ALLIED WORKS**

PEDC/STD.SPEC/15  
/ REV 00

Page 12 of 26

Sufficient quantity to cover each visible area shall be prepared in one lot to ensure uniform colour. Water to make it just workable shall be added to quantity that can be used up immediately before it starts to set.

**h) Laying**

The under bed shall be laid in panels. The panels shall not be more than 5 Sq.M. in area of which no side shall be more than 2.5 M long, for exposed location the maximum area of panel shall be 2.0 Sq.M. The panel shall be laid in alternate bays or chequered board pattern. No panel shall be cast in contact with another already laid until the latter has contracted to the full extent.

Dividing strips made of aluminium or glass shall be used for forming the panels. The strips shall exactly match the total depth of under bed plus topping.

After laying, the under bed shall be levelled compacted and brought to proper grade with a screed or float. The topping shall be laid after about 24 hours while the under bed is still somewhat 'green' but firm enough to receive the topping. A slurry of the mixture of cement and pigment already made shall be spread evenly and brushed in just before laying the topping. The topping shall be horizontal areas and thrown and pressed for vertical area to extract all superfluous cement and water and to achieve a compact dense mass fully bonded with the under bed. The surface of the topping shall be trowel led over, pressed and brought to a smooth dense surface showing a minimum 7% area covered by marble chips in a even pattern of distribution.

**i) Curing**

The surface shall be left for curing for about 12 to 18 hours and then cured by allowing water to stand on the surface or by covering with wet sack for four days.

**j) Grinding and polishing**

When the surface has sufficiently hardened it shall be watered and ground evenly with rapid cutting coarse grade (no. 40) grit blocks, till the marble chips are exposed and the surface is smooth. Then the surface shall be thoroughly washed and cleaned. A grout with already prepared mixture of cement and pigment shall be applied to fill up all pinholes. The surface shall be cured for 7 days by keeping in moist and then ground with fine grit blocks (no:120). It shall again be cleaned with water, the slurry applied again to full up any pinholes that might have appeared and allowed to be cured again for 5 days. Finally, the surface is ground a third time with very fine grit blocks (no:320) to get smooth surface without pinhole. The grinding shall be done by a suitable machine. Where grinding machine can not be used hand grinding may be allowed when the first rubbing shall be with carborundum stone of coarse grade (no:80) and final rubbing and



HYDERABAD

**STANDARD TECHNICAL  
SPECIFICATION FOR FLOOR  
FINISHES AND ALLIED WORKS**

PEDC/STD.SPEC/15  
/ REV 00

Page 13 of 26

polishing with fine grade (no:120). The surface shall be cleaned with water, dried and covered with solid free, clean sawdust if directed by the Engineer. The final polishing shall be positioned till before handing over the surface shall be dusted with oxalic acid at the rate of 0.33 gm. Per/Sq.M. water sprinkled on to it and finished by buffing with felt or Hessian bobs. The floor shall be cleaned with soft moist rag and dried. However, all excess wax polish to be wiped if and the surface to be left glossy but not slippery.

**2.1.7 GRANOLITHIC FINISH**

Granolithic finish shall either be laid monolithically over base concrete or separately over hardened base concrete.

**h) Thickness**

The finish shall be average 20 mm and minimum 12 mm thick, unless specified otherwise.

**i) Mix**

The mix shall consist of 1 part cement: 1 part coarse sand 2 parts coarse aggregate by volume. The coarse aggregate shall be very hard like granite and well graded between 6mm and 12mm. Minimum quantity of water to get workability shall be added.

**j) Laying of Monolithic Topping**

The concrete base shall be laid as per specification “cement concrete” and levelled up to the required grade. The form shall remain sufficiently protruding to take the finish.

Within about 3 hours of laying the base while it is still fully “green” the topping shall be laid evenly to proper thickness and grade. If considered necessary the surface of the base shall be roughened by the Engineer, mechanical vibrators of suitable design shall be used to press the topping firmly and work vigorously and quickly to secure full bond with concrete base.

The latency brought to the surface during compression shall be removed carefully without disturbing the stone chips. The surface shall then be lightly trowelled to remove all marks. When sufficiently set, hand trowelling shall be done to secure a smooth surface without disturbing the stone chips.

For large areas the laying shall be in panels of maximum 16 Sq.M. area. The panels shall be laid in chequered board pattern.

**k) Laying of Topping Separately on Hardened Base**



HYDERABAD

**STANDARD TECHNICAL  
SPECIFICATION FOR FLOOR  
FINISHES AND ALLIED WORKS**

PEDC/STD.SPEC/15  
/ REV 00

Page 14 of 26

The base concrete shall be prepared as stated in clause 2.0.3 and a slurry of neat cement applied just prior to laying the Granolithic concrete mix (1:1:2). The method of compaction etc., shall be same as monolithic topping.

**l) Curing**

Immediately after laying, the finish shall be protected against rapid drying. As soon as the surface has hardened sufficiently, it shall be kept continuously moist for at least 10 days by means of wet gunny bags or pouring of water on the surface. The floor shall not be exposed to heavy traffic during this period.

**m) Grinding**

If grinding is specified, it shall start only after the finish has fully set, Clause 2.1.3 © shall be followed. However, the ultimate polish required shall be decided upon by the Engineer.

**n) Finishing**

Where specified, sodium silicate or magnesium or zinc silica fluoride treatment shall be done. The number of coats to be applied shall be as specified in the Schedule of items. The concentration and method of application of the solutions shall be as specified in IS:5481.

**2.1.8 PATENT STONE**

It shall consist of an underbed and a topping laid on an already laid and matured concrete base.

**d) Thickness**

The patent stone finish shall have thickness as stipulated under clause 2.1.2(a) except that the topping shall be 6mm thick.

**e) Mix**

**i) Underbed**

The mix shall be as stipulated under clause 2.1.3 (b)

**ii) Topping**

The mix for the topping shall consist of 1 part cement and 1 part fine sand by volume.

**f) Laying**



HYDERABAD

**STANDARD TECHNICAL  
SPECIFICATION FOR FLOOR  
FINISHES AND ALLIED WORKS**

PEDC/STD.SPEC/15  
/REV 00

Page 15 of 26

The Patent Stone finish, including the under bed shall be laid in alternate bays or in chequered board pattern. No panel shall be as in contact with another already laid till the concentration of the latter has already taken place.

The maximum area of each panel shall be 3 SQ.M. of which no side shall be more than 2 M long. A cement grout shall be applied and worked into the surface to receive the finish, the under bed then laid, compacted and levelled to proper grade with a screed or float. The topping shall be applied evenly on the under bed while it is not fully set but firm enough and rolled and pressed to get full bond. The topping shall be trowel led to a dense finish to the satisfaction of the Engineer. All trowel marks shall be mopped out with a soft cloth to give a clean smooth surface.

After the surface is sufficiently set, the finished floor shall be kept moist for 7 days for curing. If desired the finish shall be polished as directed by the Engineer.

**2.1.9 METALLIC HARDENER LIKE “IRONITE” FINISH**

This will consist of a topping (incorporating iron particles) to bond with concrete base while the latter is “Green”>

**a) Thickness**

Unless otherwise specified the metallic hardener finish shall be of 12 mm depth.\

**b) Material**

The hardening compound shall be uniformly graded iron particles free from non-ferrous metal impurities, oil, grease, sand soluble alkaline compounds or other injurious materials. When desired by the engineer, actual sample shall be tested.

**c) Mix**

Proportion of the metallic hardener shall be as specified or as indicated by the manufacturer. However, in absence of any such direction 1 part metallic hardener shall be mixed dry with 4 parts cement, by weight. To this mixture 8 mm nominal size stone chips shall be added in proportion of 1 part cement (mixed with hardener) to 2 parts of stone chips by volume and uniformly mixed.

Minimum quantity of water shall be added to make it workable.

**d) The concrete floor shall be laid as per specification :Cement Concrete” and**



HYDERABAD

**STANDARD TECHNICAL  
SPECIFICATION FOR FLOOR  
FINISHES AND ALLIED WORKS**

PEDC/STD.SPEC/15  
/ REV 00

Page 16 of 26

levelled up to the required grade. The forms, if any shall remain sufficiently projecting to take the finish the surface shall be roughened by wire brush as soon as possible.

The finish shall be laid while the concrete under bed still very “green” within about 3 hours of laying of the latter. The finish shall be of uniform thickness and even dense surface without trowel marks, pin holes etc. This topping layer shall be pressed firmly and worked vigorously and quickly to secure full bond with the concrete base. Just when the initial set starts the surface shall be finished smoothed with steel trowel.

**2.1.10 MASTIC ASPHALT FINISH**

This is a one layer treatment on concrete or brick base.

**a) Thickness**

The thickness shall be as specified in the drawing or schedule of items.

**b) Materials**

Bitumen shall be industrial bitumen of the graders 90/15 and 74/15 conforming to IS:702.

Mineral filler shall be dry stone dust passing through 75 micron IS Sieve,

Fine aggregate shall be crushed and graded natural lime stone or other hard-work.

Coarse aggregate shall be crushed siliceous stone or other approved aggregate 6 mm stone chips shall be used for finish up to 20mm thick & 10mm chips for thicker finish.

**c) Composition**

Bitumen mastic shall conform to IS:1195 and shall be either brought to site blocks weighing about 25 Kg. Or prepared at site. If brought in blocks, these shall be remelted in mechanically agitated mastic cookers and coarse aggregate, preferably, preheated fed in successive portions until the complete change is thoroughly incorporated. At no stage during the remelting and mixing process, shall the temperature exceed 205 deg.C.

**d) Laying**

The hot mastic shall be laid on dry base surface cleaned thoroughly by wire brushing and sweeping. The mastic shall be levelled and when cooled to some extent shall be finished with a wooden float with addition of small quantity of fine sand if required. No load shall be allowed till the finish has cooled to normal temperature.



HYDERABAD

**STANDARD TECHNICAL  
SPECIFICATION FOR FLOOR  
FINISHES AND ALLIED WORKS**

PEDC/STD.SPEC/15  
/ REV 00

Page 17 of 26

The mastic shall be laid in suitable panels of about 15 Sq.M. in area each formed by formers. Succeeding panels be laid over lapping the finish panel so as to melt its edges and form a continuo finish without joint.

**2.1.0 CHEMICAL RESISTANT IN SITU FINISH**

Chemical resistant in situ finish shall be as epoxy resin with suitable filler material over a primer or called for in the Schedule of item. The minimum thickness shall be 6mm. About its performance the Engineer shall have to be fully satisfied by test results and examination of similar treatment already in Existence. The Contractor shall get it done by a specialised manufacturer, get guarantee of performance from the organization and pass it on to the Owner in addition to his own guarantee.

**2.2.0 Tiled Finish**

These shall include finish tiles, stone slabs and similar manufactured or natural items over already laid and matured base of concrete or masonry by means of an underbed or an adhesive layer.

**2.2.1 Terrazzo Tile Finish**

The finish will consist of manufacture terrace tile and an underbed.

**a) Thickness**

The total thickness including the underbed shall be minimum 40 mm for floors 30 mm for walls unless otherwise specified.

The skirting, dado and similar vertical surfaces shall project out 6 mm uniformly from the adjacent plaster or other wall finishes. The necessary cutting into the surface receiving the tiled finished, to accommodate the specified thickness shall be done.

**b) Tiles: Terrazzo**

The tiles shall, unless specifically permitted in special cases by machine made under quality control in a shop. The tile shall be pressed hydraulically to a minimum of 140 Kg. per Sq. Cm.

Each tile shall bear on its back permanent and legible trade mark of the manufacturer. All angles of the tiles shall be right angles all arises shape and true, colour and texture of the wearing face uniform throughout. Maximum tolerance allowance length and breadth shall be + or \_ 1 mm and the thickness + 3 mm. Face of the tile shall be plane, free from pin holes and other blemishes.

The tiles shall be composed of a backing and topping. The topping shall be of uniform thickness not less than 10 mm.



HYDERABAD

**STANDARD TECHNICAL  
SPECIFICATION FOR FLOOR  
FINISHES AND ALLIED WORKS**

PEDC/STD.SPEC/15  
/ REV 00

Page 18 of 26

The total thickness including the topping shall be as specified but not less than 20 mm in any case.

The topping shall be as specified under clause 2.1.3 (b)

The tile shall be cured at the shop for at least 14 days before delivery to the site. First grinding shall be given to the tiles at the shop before delivery. Tiles shall be packed properly to prevent damage during transit and storage. The tiles must be carefully stored to prevent staining by damp, rust, oil, and grease or other chemicals.

Tiles made in each batch shall be kept and used separately so those colours of each area of the floor may remain uniform.

The manufacturer shall supply along with the tiles the grout mix containing cement and pigment in exact proportions as used in topping of the tiles. The containers for the grout mix shall be suitably marked to relate it to the particular type and batch of tiles.

c) Mix: Underbed

Underbed shall be same as CI. 2.1.2 (b) (1).

d) Laying

The underbed mortar shall be evenly spread and brought to proper grade and consolidated to a smooth surface. The surface shall be roughened for better bond. Before the underbed had time to set and while it is still fairly moist but firm, cement shall be hand dusted over it or a cement slurry applied and the tiles shall immediately be placed upon and firmly pressed by wooden mallet on to the underbed until it achieves the desired level. The tiles shall be kept soaked for about 10 minutes just before laying. The joints between tiles shall be as close as possible and not more than 1.5 mm wide.

Special care shall be taken to check the level of the surface and the lines of the joints frequently so that they are perfect.

When tiles are required to be cut to match the dimensions these shall be sawn and edges rubbed smooth. The location of cut tiles shall be planned in advance and approval of the Engineer taken.

All the junction of horizontal surface with vertical surface the tiles on the former shall enter at least 12 mm under the latter.

After fixing, the floor shall be kept moist and allowed to mature undisturbed for 7 days. Heavy traffic shall both be allowed.



HYDERABAD

**STANDARD TECHNICAL  
SPECIFICATION FOR FLOOR  
FINISHES AND ALLIED WORKS**

PEDC/STD.SPEC/15  
/ REV 00

Page 19 of 26

If desired dividing strips as specified under Clause 2.1.3 © may be used for dividing the work into suitable panels.

c) Grinding and Polishing

Procedure shall be same as Clause 2.1.3 © 2. Grinding shall not commence earlier than 14 days after laying of tiles.

2.2.2 The finish shall consist of manufactured grey or coloured cement tiles or terrazzo tiles with chequered face and an underbed laid over concrete or brick surface.

a) Thickness

Thickness shall be same as in clause 2.2.1 (a)

b) Tiles: Chequered

The tiles shall have chequres not less than 2.5 cm c/c and not more than 5 cm c/c. Depth of grooves shall be not less than 5 mm. The grooves shall be uniform and straight.

The tiles shall conform to clause 2.2.1 (b) except that these may have the topping interrezzo or plain grey cement of colour pigment added to cement as specified.

c) under bed

As per Clause 2.2.1 ©

d) Laying

As per Clause 2.2.1 (d)

e) Grinding and Polishing

As per Clause 2.2.1 (e) except that the tiles shall be ground and polished by hand after laying taking special care in polishing the grooves properly and uniformly.

2.2.3 Glazed Tiles Finish

This finish shall be composed of glazed earthen ware an under bed laid over a concrete or masonry base.

a) Thickness

The total thickness shall be between 20 mm and 25 mm including the under bed.



HYDERABAD

**STANDARD TECHNICAL  
SPECIFICATION FOR FLOOR  
FINISHES AND ALLIED WORKS**

PEDC/STD.SPEC/15  
/ REV 00

Page 20 of 26

The tile finish on vertical surface shall project out 6 mm uniformly from the adjacent plaster or other wall finishes. The necessary cutting into the surface receiving the finish, to accommodate the specified thickness shall be done.

b) Tiles: Glazed

The tiles shall be of earthenware, covered with glaze white or coloured, plain or with designs, of 150 mm x 150 mm nominal sizes and 10 mm thick unless otherwise specified. The tolerance shall be + or - 1.5 mm for length and breadth and + or - 0.5 mm for thickness specials like internal and external angles, beads, covers, cornices, corner pieces etc., shall match. The top surface of the tiles shall be glazed with a gloss or matt unfading stable finish as desired by the Engineer. The tiles shall be flat and true to shape. The colour shall be uniform and fractured section shall be fine grained in textures, dense and homogenous. The tiles shall be strong and free from flaws like cracks, craze, spaces, crawling, etc., and other imperfections. The edge and the underside of the tiles shall completely free from glaze and the underside shall have ribs or indentations for better anchorage with the fixing mortar.

The coloured tiles, when supplied, shall preferably come from one batch to avoid difference in colour.

c) Mix: Under bed

The mix for the under bed shall consist of 1 part cement and 3 parts coarse sand y weight mixed with sufficient water or any other mix if specified.

d) Laying

Same as Clause 2.2..1 (d)

e) Finishing

The joints shall be cleaned and flush pointed with white cement and cured for 7 days by keeping it wet. The surface shall be cleaned with soap or suitable detergent, washed fully and wiped with soft cloth to prevent scratching before handing over.

2.2.4 Tesserae Finish (Mosaic etc.)

This finish consists of manufactured vitreous, glass, ceramic or similar hard small pieces set in an under bed over a concrete or masonry surface, already laid.

a) Thickness

The total thickness including the under bed shall be between 16 mm and 23 mm.



HYDERABAD

**STANDARD TECHNICAL  
SPECIFICATION FOR FLOOR  
FINISHES AND ALLIED WORKS**

PEDC/STD.SPEC/15  
/ REV 00

Page 21 of 26

b) Tessa Rae Finish

These shall usually be 6 mm thick small piece of ceramic vitreous china, tinted glass or similar hard wearing, strong, and durable material in desired shapes and sizes and patterns.

The supply shall come in the desired pattern in full or sections conveniently for handling, stuck topieces of strong thick paper on the surface to be exposed. The gum used for this purpose must be water soluble and non-staining. The sections shall be properly marked to avoid mistakes and master drawing shall be available at the site for guidance.

c) Mix: Underbed  
Same as Clause 2.2.3 ©

d) Laying

The specification for laying if given by the manufacturer of the item shall be followed provided it is approved by the Engineer, otherwise Clause 2.2.3 (d) shall generally be followed. However, instead of grey cement the slurry shall be made with white cement to fix the panels. The paper mounted patterns in sections shall be carefully placed and pressed in position true to lines and levels. Earliest possible the paper shall be peeled off and surface examined and cleaned, joints flush pointed with white cement and cured for 7 days by keeping it wet.

2.2.5 Chemical Resistant Tiled Finish

This shall include all varieties of special tiles used for specific chemical resistance function and an underbed over already laid concrete or masonry.

a) Tiles

The chemical resistant tiles as detailed in the Schedule of items shall be of the best indigenous manufacture unless otherwise specified and shall be resistant to the chemical described in the Schedule of items. The tiles shall have straight edges, uniform thickness, plain surface, uniform non-fading colour and textures.

Glazed tiles if permitted to act as chemical resistant Finish shall be considered under Clause 2.2.3

Usually the chemical resistant tiles shall not absorb water more than 2% by weight. The tiles shall have at least compression strength of 700 Kg/cm<sup>2</sup>. The surface shall be abrasion resistant and durable.

b) Laying



HYDERABAD

**STANDARD TECHNICAL  
SPECIFICATION FOR FLOOR  
FINISHES AND ALLIED WORKS**

PEDC/STD.SPEC/15  
/ REV 00

Page 22 of 26

The mortar used for setting or for underbed the tiles shall be durable and strong. The group which shall be to the full depth of tile shall have equal chemical resistant properties. Joints shall be pointed if so desired. The setting and fixing shall be according to the manufacturer's specification approved by the Engineer.

**2.2.6 Rubber, Vinyl or Vinyl Asbestos Tiles Finish**

This shall include various types of tiles manufactured item rubber, vinyl, etc, set with a adhesive on concrete or masonry base. An underbed may be required to secure desirable surface and grade.

**a) Thickness**

The thickness of the tiles shall be mentioned in the Schedule or in drawing.

**b) Tiles**

Unless otherwise, desired the tiles shall be squares of approved dimensions. The tolerance shall be + / - 1.5 mm.

The face of the tiles shall be free from porosity, blisters, cracks, embedded foreign molters or either physical defects which affect appearance or serviceability. All edges shall be cut true and square. The colour shall be non fading and uniform in appearance, insoluble in water and resistant to alkalis, cleaning agents and usual, floor polishes.

Each tile shall be marked on the back legibly and indelibly with manufacturer's trade mark, the thickness, sizes, batch number and date of manufacturer.

Tiles shall be delivered securely packed and stored in clean, dry well ventilated place at a temperature near about to that the tiles shall be called upon to stand ultimately. Adhesive to be used for sticking the tiles shall be approved by the tile manufacturer. The adhesive shall have a short drying time and long life in addition to toughness.

**c) Mix: Underbed**

The under bed where required to make up the specified thickness or to give the required grade or to get the right type of surface shall be composed of 1 part like putty: 1 part cement: 4 parts coarse sand with just sufficient water to make it workable.

**d) Laying**

The tiles shall be kept in the room to be tiled for at least 24 hours to bring them to the same temperature as the room. For air-conditioned space, the air-conditioning shall be completed before tiling is taken up.



HYDERABAD

**STANDARD TECHNICAL  
SPECIFICATION FOR FLOOR  
FINISHES AND ALLIED WORKS**

PEDC/STD.SPEC/15  
/ REV 00

Page 23 of 26

The surface to receive this finish shall be firm even textured but not too smooth, without undulations and other deficiencies. If an underbed is laid the same shall be cured for at least 7 days by keeping it moist and then fully dried.

The surface shall be thoroughly cleaned. All loose dust particles shall be removed. Oil and grease if any shall be completely cleaned by use of detergent.

The adhesive shall be applied to fully dry surface in desired thickness uniformly. The adhesive shall also be applied to the backs and edges of the tiles and allowed to surface dry. The tiles shall be placed neatly on the surface exactly to the approved pattern and set with a suitable tool. If the edges tend to curl, weights are to be used to keep the edges down. Special care shall be taken to avoid formation or air pockets under the tiles. The joints shall be very fine. Any adhesive squeezed out through the joints shall be removed immediately.

c) Finishing

If any adhesive mark is there on the surface a soft cloth soaked in solvent shall be used to wipe it off. The surface shall be cleaned with soft soap, dried and polished with as approved type of polish just before handing over.

2.2.7 Stone slab finish: Marble, Stone and Similar Fine Grained Stone

a) Thickness

The underbed shall be minimum 12 mm and average 20 mm thick. The slabs may be 25 mm., 30 mm or 40 mm thick as specified.

b) Stone Slab

The stone slabs shall be made from selected stock which are hard, sound, homogenous and dense in texture and free from flaws. Angles and edges shall be true, square, free from chipping and surface shall be plane. The slabs shall preferably by machine cut to the required dimensions. Tolerance or + / - 5 mm in dimensions and + / - 2 mm. in thickness will be allowed. Unless specified the slabs shall be minimum 300 mm x 300 mm.

The stone slabs shall come from specific regions and in specified quality with top surface fine chisel dressed. All sides shall also be fine chisel dressed to the cull depth to allow finest possible joints.

The slabs shall be delivered to the site well protected against damages and stored in dry place under cover.

c) Mix: Underbed

Same as Clause 2.2.1 ©



HYDERABAD

**STANDARD TECHNICAL  
SPECIFICATION FOR FLOOR  
FINISHES AND ALLIED WORKS**

PEDC/STD.SPEC/15  
/ REV 00

Page 24 of 26

d) Laying

The sides and top surface of the slabs shall be machine rubbed or table rubbed with coarse sand stone and washed clean before laying.

The underbed mortar shall be evenly spread and brought to proper level on the area under each slab. The slab shall be laid over the underbed, pressed and tapped down with wooden mallet to the proper level. The slab shall then be lifted and the underbed corrected as necessary and allowed to stiff on a little. Next, a thick cement slurry shall be buttered with slurry of cement, grey/white/mixed with pigment matching the colour of the stone slabs. The slab shall be gently laid and tapped with wooden mallet to bed properly to a vary find joint and to the required level. All surplus cement slurry shall be removed and the surface mopped clean with wet soft cloth. The laid finish shall be cured for 7 days by keeping it wet.

e) Polishing, Finishing

Fine chiselling shall be done to remove the slight undulations that usually exist at the joints. The polishing and finishing shall be done as specified under Clause 2.2.1 (e). However, the joints shall be so fine in the case of stone slabs that grouting shall not be called for.

2.2.8 Stone Slab Finish: Sand Stone and Similar Coarse Grained Stone Finish

Generally Clause 2.2.7 shall be followed except that the workmanship and finish shall not be fine as which are explained hereunder.

The slabs shall be rough chiselled or fine chiselled as specified. Tolerance may be allowed up to + / - 6 mm for rough finish, but no sharp unevenness and shall be allowed. For fine chiselling the unevenness shall be limited to + / - 2 mm.

The sides shall be chisel dressed at least to half slab depth so that the maximum deviation from straight line shall be within 25 mm. Beyond this depth the edge may be slightly splayed.

The joint thickness shall be kept limited to 5 mm in case of rough finish and 3 mm in case of fine finish unless wider joints are specified. The joints shall be grouted with white or coloured cement.

3.0.0 ACCEPTANCE CRITERIA

The finish shall be checked specially for:

- a) Level, Slope, Plumb as the case may be
- b) Pattern and symmetry



HYDERABAD

**STANDARD TECHNICAL  
SPECIFICATION FOR FLOOR  
FINISHES AND ALLIED WORKS**

PEDC/STD.SPEC/15  
/ REV 00

Page 25 of 26

- c) Alignment of joints, dividing strip etc.
- d) Colour, texture
- e) Surface finish
- f) Thickness of joints
- g) Details at edges, junctions etc.
- h) Performance
- i) Precautions specified for durability

**4.0.0 RATES**

Rates shall be for the complete finishing work including necessary forms, underbed, sticker and preparation of the surface including cutting and chipping to receive the finish but exclusive of the base unless specially included in Contract.

The dividing strips in case of in situ terrazzo finish shall be included in the rates. Similarly, indentations, lay in desired patterns and in panels shall be inclusive in the rates.

All necessary cutting tiles, slabs, etc., cost of specials if any shall be included in the rates. No extra shall be paid for rounding corners and edges. Unless, specifically mentioned otherwise, same rules will apply to floor skirting, dado, treads, nosing etc.

**5.0.0 METHOD OF MEASUREMENT**

The finished surface shall be measured for area. Any opening less than 0.1Sq.M. (and 0.05 Sq.M. in case of marble finish only) shall not be taken into account neither any extra shall be paid for it.

For terrazzo finish, either in situ or tiled shall be paid at the same rate unless mentioned separately in the Schedule of Items.

Except in case of in situ terrazzo finish and unless mentioned in the Schedule dividing strips shall be measured in length.

**6.0.0 I.S. CODES**

Important relevant codes for this section:

IS:777 : Glazed earthen ware tiles



HYDERABAD

**STANDARD TECHNICAL  
SPECIFICATION FOR FLOOR  
FINISHES AND ALLIED WORKS**

PEDC/STD.SPEC/15  
/ REV 00

Page 26 of 26

- IS:1196 : Code of practice for laying bitumen mosaic flooring.
- IS:1197 : Code of practice for laying of rubber floors.
- IS:1237 : Cement concrete flooring tiles
- IS:1443 : Code of practice for laying and finishing of cement  
concrete flooring tiles.
- IS:2114 : Code of practice for laying in site terrazzo floor.
- IS:3641 : PVC asbestos floor tiles.
- IS:4660 : Specification for acid resistant bricks
- I:5516 : Code of practice for laying of flexible PVC Sheet and tile  
Flooring
- IS:5491 : Code of practice for laying site Granolithic floor topping.



**STANDARD TECHNICAL  
SPECIFICATION FOR GLASS AND  
GLAZING**

PEDC/STD.SPEC/  
16- REV 00

Page 1 of 4

HYDERABAD

**GLASS AND GLAZING**

REV. NO.	PRAPARED	APPROVED	DATE

**COPYRIGHT AND CONFIDENTIAL**

The information on this document is the property of BHARAT HEVY ELECTRICAL LTD.It must not be used directly or indirectly in any way detrimental to the interest of the Company.



## STANDARD TECHNICAL SPECIFICATION FOR GLASS AND GLAZING

PEDC/STD.SPEC/  
16- REV 00

Page 2 of 4

HYDERABAD

### 1.0 SCOPE

The work in general shall consist of supplying and supplying fixing all glass and glazing including all clips, putty, mastic cement etc., whatever required as shown on drawings and specification, supply of metal glazing beads and neoprene gaskets shall not be included in this scope.

This shall also include the fixing of all glass and glass supplied by the Owner at his site stores.

### 2.0 INSTALLATION

#### 2.1 General

The Contractor shall supply and install all glass and glazing as required for various doors, windows, sashes, ventilators and fixed louver, miscellaneous glazing and partitions, unless otherwise stated from approved manufacturer like Hindustan Pilkinton or equivalent, having uniform refractive index and free from flaws, specks and baubles. The glass shall be brought to site in the original packing from the manufacturer and cut to size at site. The cut edges shall be straight and free from chips, spalls or any other damages.

#### Materials

- a) Glare reducing or heat absorbing glass shall be “Calorex” of Hindustan pilkinton or approved equivalent and special care shall be taken to grind smooth and round off the edges before fixing or as specified in schedule of items
- b) Clear glass shall be flat drawn sheet glass and shall be at least 4 mm thick. Sheet glass for doors shall be minimum 5.5 mm thick or as specified in schedule of items
- c) Wired glass shall be thick rolled glass with centrally embedded 24c, wire mesh of Georgian type. This may be of clear or colored glass, as shown in drawings or schedules.
- d) Obscure glasses shall have a cast surface in one side.
- e) Colored and floured glass shall be as per approved sample.
- f) In general, the party shall conform to IS : 400 and be of best quality from approved manufacturer. It shall be brought to site in the manufacturer’s original packing; Quick setting putty glass is used where it shall be non-setting type. Type and thick of glasses shall be as per schedule of items.



## STANDARD TECHNICAL SPECIFICATION FOR GLASS AND GLAZING

PEDC/STD.SPEC/  
16- REV 00

Page 3 of 4

HYDERABAD

- g) Neoprene gasket with snap-fit glazing heads shall be fixed as per manufacturer's instructions and shall sit snugly against glass to give a leak proof installation.

### 2.3 Glazing, Setting and Finish

All glazing clips, bolts, nuts, putty mastic cement etc., as required shall be supplied by the contractor.

All glass shall be thoroughly cleaned before putting in position. Each be supplied shall be held in place by special glazing clips of approved type. As specified in relevant I.S: Codes, four glazing clips shall be provided per glass pane, except for large panes were six or more clips shall be sued as per Engineer's instruction. All holes that may be necessary for holding the clips glazing heads and all other attachments shall be drilled by the Contractor.

Glass panes shall be set without springing and shall be bedded in putty and back puttied, except where molding or gasket are specified, putty, mastic cement etc., shall be smoothly finished to the even line and figured glass shall be set with smooth side out.

Where glass will be supplied by Owner, the contractor shall cut it to size and fix them in the same as specified above.

Necessary glazing clips, putty, mastic cement etc., shall be supplied by the contractor. The Contractor shall be responsible for damage of Glass supplied by the owner. During handing, transportation, fixing etc., maximum wastage allowance shall be 5%

After completion of glazing work, the contractor shall remove all dirt stains, excess putty etc., clean the glass panes and leave the work in perfectly acceptable condition. All broken cracked or damaged glass shall be replaced by new ones at the contractor's own cost.

### 3.0 ACCEPTANCE CRITERIA

- a) All installation shall be free from cracked, broken or damaged glass. Edges of large panes of thicker glass and heat absorbing glass shall be inspected carefully for chipped, cracked or underground edges.
- b) Glazing shall be carefully done to avoid direct contact with metal frames .
- c) Al glass be embedded in mastic or fixed by neoprene gaskets to give a leak proof installation.
- d) At completion, the shall be free from dirt. Stains, excess putty etc. to the complete satisfaction of the engineer.

### 4.0 RATES



## STANDARD TECHNICAL SPECIFICATION FOR GLASS AND GLAZING

PEDC/STD.SPEC/  
16- REV 00

Page 4 of 4

HYDERABAD

- a) Rates shall be unit rates for supply and/or installation of different kinds of glass mentioned in the Schedule of items.
- b) No separate payment shall be made for glazing clips, mastic Cement, putty, nails etc., for drilling holes in frames for inserting glazing clips.
- c) No separate payment shall be made for cutting of glass to required size. Edge finishing etc., if the glass is supplied by the contractor.
- d) Payment shall be made for cutting of glass to required size edge finishing etc., if the glass is supplied by the owner.
- e) No separate payment shall be made for cleaning the glass after installation.

### 5.0 METHOD OF MEASUREMENT

- a) All supply and /or installation of glass shall be measured for actual area of work done.
- b) When glass is supplied by the owner, the cutting of glass shall be measured for actual length of cut edges.

### 6.0 I.S. CODES

Following are some of the important I.S. Codes relevant to this Section ;

IS: 3548 – Code of practice for glazing in building.

IS: 1083 – Code of practice for fixing and glazing metal doors, windows & ventilators.



**STANDARD TECHNICAL  
SPECIFICATION FOR METAL DOORS,  
WINDOWS, VENTILATORS, LOUVERS  
ETC.**

PEDC/STD.SPEC/  
17- REV 00

Page 1 of 10

HYDERABAD

**METAL DOORS, WINDOWS, VENTILATORS,  
LOUVERS ETC.**

REV. NO.	PREPARED	APPROVED	DATE

**COPYRIGHT AND CONFIDENTIAL**

The information on this document is the property of BHARAT HEVY ELECTRICAL LTD.It must not be used directly or indirectly in any way detrimental to the interest of the Company.



**STANDARD TECHNICAL  
SPECIFICATION FOR METAL DOORS,  
WINDOWS, VENTILATORS, LOUVERS  
ETC.**

PEDC/STD.SPEC/  
17- REV 00

Page 2 of 10

HYDERABAD

### **1.0.0 SCOPE**

The work in general shall consist of supplying and/or erecting and installing of all metal doors, windows, ventilators, glazed partitions, etc., as shown on drawings, with all materials complete excluding supply of glass and glazing. The scope of work shall also include the assembly and erection of all doors, windows, louvers, glazed partitions, etc., for which fabricated materials shall be supplied by the Owner from the store of site. Supplying and/or fixing of all door and window accessories and hard ware is also included in the scope.

### **2.0.0 INSTALLATION**

#### **2.1.0 Materials**

Steel sections used for fabrication of doors, windows etc., shall be standard rolled steel sections specified in IS: 1038 and IS: 1361 or as specified in drawings and schedules.

Steel sheets for frames, shutters, louver blades etc., shall be of gauge mentioned in drawings and schedules.

Aluminum sections for fabrications doors, partitions etc., shall be extruded sections conforming to IS : 1048 and 1940 or as manufactured by Indian Aluminum Company Limited or approved equivalent. The alloy used shall conform to IS Designation He 9-wp of IS : 733.

Hardware and fixtures shall be as specified in “ Schedule of Fixture” and the best quality from approved manufacturers shall only be used. The Tendered shall specifically state the particular manufacturer’s materials he proposes to use “schedule of Fixtures” is for the purpose of stating the minimum requirement and improper alignment or faulty operation due to inadequate strength of Hardware of fixing shall entirely be the Contractor’s responsibility.

All Hardware and fixtures shall be able to withstand repeated use Door closures shall conform to IS : 3564 and shall be suitable for doors weighing 61-80 kg unless otherwise stated in schedule. Each closer shall be guaranteed against manufacturing defect for one year and any defect found within this period shall be rectified or the closer replaced free of charge. Concealed door closures shall be either floor mounted or transom mounted. Suitable for installation with metal doors. It shall conform to the performance requirements and endurance test stated in IS : 3564- Appendix A.

The contractor shall submit samples of each type of hardware to the Engineer The approved samples shall be retained by Engineer for comparison of bulk



**STANDARD TECHNICAL  
SPECIFICATION FOR METAL DOORS,  
WINDOWS, VENTILATORS, LOUVERS  
ETC.**

PEDC/STD.SPEC/  
17- REV 00

Page 3 of 10

HYDERABAD

supply. The samples shall be returned to the contractor towards the end for incorporation in the job.

The mastic for caulking shall be of best quality from a manufacturer approved by the Engineer in general, the for fixing of metal frames shall be as per IS : 1081 and /or as approved by the Engineer.

**2.2.0 Fabrication**

**2.2.1 Steel Doors, Windows, Ventilators, Louvers etc.**

**a) Door Frames**

Frames shall be fabricated from 16 g sheets. They shall be mortised, reinforced, drilled and lapped for hinges and lock and bolt strikes, where necessary, frames shall be reinforced for door closures. Welded construction with mired corners shall be used. Rubber door silencers shall be furnished for the striking lamb. Loose “T” masonry anchors shall be provided. Frames shall finish flush with floor and adjustable floor anchors shall be supplied. Frames shall be brought to site with floor ties/weather bats installed in place.

**b) Double plate Flush Door Shutters**

Door shutter shall be 40 mm thick, completely flush design and shall comprise of two outer sheets or 18 G steel sheets, rigidly connected and reinforced inside with continuous vertical 20 C stiffeners, spot welded in position at not more then 150 mm on centers.

Both edges of doors shall be joined and reinforced full height by steel channels placed immediately inside and welded to the door faces. Top and bottom of doors shall be reinforced horizontally as shown on drawing by steel channels running full width of door. Doors shall not have more then 2.5 mm clearance at jambs and heads, shall be reinforced at corners to prevent sagging or twisting. Pairs or double doors shall have meeting – stile edges beveled or rebated. Where shown on drawing or called for in the schedule of items. The doors shall be sound deadened materials.

Doors shall be mortised, reinforced, drilled and tapped in shop for hinges, locks and bolts. They shall also be reinforced for closures. Push-plates and other surface hardware where necessary, any drilling and tapping required for surface hardware shall be done at site. Where shown in drawing, provision shall be made for fixing glazing, vision panels, louvers etc., glazing moldings shall be of 18 G steel or extruded aluminum sections with profiles shown in drawings and suitable for



**STANDARD TECHNICAL  
SPECIFICATION FOR METAL DOORS,  
WINDOWS, VENTILATORS, LOUVERS  
ETC.**

PEDC/STD.SPEC/  
17- REV 00

Page 4 of 10

HYDERABAD

fixing 6 mm glass. Louvers blades shall be v or z shaped and made out of 16 g sheets.

**c) Single Sheet door shutters**

Single sheet doors shall be made from best quality 18 G mild steel sheets, and shall present a flush surface on the outside. The inside shall be stiffened with semi-tubular edge and central stiffening rail which shall convey the lock and other furniture. The frames shall be made from best quality 16 G mild steel sheets.

Whenever required as shown on drawings, provisions for fixing glass panes, louvers etc., shall be made.

The manufacturing shall be done as specified in 2.2.1 (b) “Double plate Flush Door Shutters”.

**d) Sliding Doors**

Sliding doors shall be double plate or single plate construction as called for in drawing and schedules made out of 18 gauge steel sheets with adequate stiffeners. The Contractor shall specify the weight of the door in his shop and submit the manufacture’s catalogue of the sliding gear he proposes to use. Where shown on drawing or call for in the Schedule of items, the Contractor shall make provision for openings to the door for mono- rail beams. Doors shall make positively to exclude rain water from seeping in when called for in schedule, sliding doors shall withstand specified under all ambient conditions.

**e) Door Threshold**

Door threshold shall be provided as shown on drawings. Doors without threshold shall have Boston tie of approved type.

**f) Steel Windows, Sashes, Ventilators etc.**

These shall conform in all respects to IS : 1038 and IS : 1361 latest editions and as shown on drawings. The details as called for in the above codes shall be applicable for coupling mullions, transoms, weather bars, pivot arrangements for ventilators, etc., or as shown on drawings or called for in the Schedule of items

All welds shall be dressed flush on all exposed and contact surfaces.

Where composite unit openings are shown on drawings ,the individual window units shall be joined together, with requisite rooms and mullions



**STANDARD TECHNICAL  
SPECIFICATION FOR METAL DOORS,  
WINDOWS, VENTILATORS, LOUVERS  
ETC.**

PEDC/STD.SPEC/  
17- REV 00

Page 5 of 10

HYDERABAD

as shown on drawings. All windows shall be outside glazed fixed with putty or metal glazing beads as shown on the drawings and/or specified, under Schedule of items.

All welds shall be dressed flush on all exposed and contact surfaces.

Where composite unit opening are shown on drawings, the individual window units shall be joined together, with requisite rooms and mullions as shown on drawings. All windows shall be outside glazed fixed with putty or metal glazing beads as shown on the drawings and/or specified under Schedule of items. Where aluminum glazing beads are specified, they shall be extruded aluminum channel :3 mm x 9.5 mm x 1.6 mm (India: section No. 2209) unless otherwise shown on drawings, Aluminum beads shall be given one coat of zinc chromate primer before fixing to windows.

### **2.2.2 Aluminum Door, Windows and Frames**

Extruded sections shall have a minimum 3 cm wall thickness. All sections shall be approved by the Engineer before fabrication is taken up. Doors, frames mullions, transom etc., shall be anodized in a bath of sulfuric acid to provide a mullions, coating of minimum 0.6 mm thickness. The anodized materials shall then be sealed by immersing in boiling water for 15 minutes. A protective transparent coating shall be applied to the sections before shipment from the factory.

All work shall be fitted and shop assembled to a fist class job, and ready for erection. Shop joints shall be made to hair lines and then welded or braced by such method as will produce a uniform color throughout the work, work on the above, other then described, shall be carefully fitted and assembled with neat joints with concealed fasteners. Wherever possible, joints shall be made in concealed Locations and on edges of doors filed connections of all works may be made with concealed screws of other approved type of fasteners Glazing beads shall be snap fit type without visible screws and shall be of size to accommodate 6 mm thick glazing. All work shall be adequately braced and reinforced as necessary for strength and rigidity.

### **2.2.3 Shop Coat or paint**

The shop paint for steel doors, Widows etc., shall be lead of zinc chromate primer paint from approved manufacturer. All surfaces shall be toughly cleaned of rust, grease, loose, mill scales etc., and even one coat of shop paint.

Portions like mullions, transoms etc., which will be inaccessible after assembly of units shall be given an extra coat of paint before assembly.



**STANDARD TECHNICAL  
SPECIFICATION FOR METAL DOORS,  
WINDOWS, VENTILATORS, LOUVERS  
ETC.**

PEDC/STD.SPEC/  
17- REV 00

Page 6 of 10

HYDERABAD

Where called for in the schedule of items, all steel doors, windows, etc, shall be hot dry galvanized to give a coating weight of 1-1/2-2 or per sft. One coat zinc chromate primer coat shall than be applied as shop paint.

Portions of aluminum frame which come in contact with masonry construction, shall, before shipment from work shop, be protected with a heavy coat of alkali paint. Aluminum coming in contact with other incompatible metals shall be coated with zinc chromate primer.

#### **2.4.0 Handing & Storage of Fabricated Material**

All metal doors, windows, etc., shall be packed and crated properly before dispatch, to ensure that there will be do no damage to the fabricated materials boarding into wagons and trucks shall be done with all care to ensure safe arrival of materials at site in undamaged condition.

When taking delivery of items supplied by Owner, the Contractor shall satisfy himself that the items supplied are upto the specified standard. Any defect detected shall promptly be brought to the notice of the Engineer.

All metal doors, windows etc., shall be stored under cover in a way to prevent damage or distortion. Special care shall be taken to prevent staining of aluminum products by rest, mortar etc.,

#### **2.5.0 Assembly & Erection at Site**

In general, the fixing of steel doors, windows, ventilators, louvers, etc., shall conform to IS : 1081 and as shown on drawings. The Contractor shall assemble and install all steel doors, windows, sashes, fixed metal louvers, etc., including transoms and mullions for composite units in respective places as shown on drawing, keeping proper lines and levels, and in approved workman like manner, to give trouble free and leak-proof installations. The installation shall be done according to the instructions of the manufacturer and/or as approved by the Engineer. If required by the Engineer, the installation shall have to be carried out under the supervision of the manufacturer's staff. The Contractor shall take every precaution against damage of the components during installation. Necessary holes, chases, etc., required for fixing shall be made by the Contractor and made good again as per original, after installation, without any extra charge.

After installation of steel doors, windows, etc., all abrasions to shop- coat of paint shall be retouched and made good with the same quality or paint used in shop – coat.

All coupling mullions, shall be well bedded I mastic. The Contractor shall bring to the site the mastic cement in original sealed containers of



**STANDARD TECHNICAL  
SPECIFICATION FOR METAL DOORS,  
WINDOWS, VENTILATORS, LOUVERS  
ETC.**

PEDC/STD.SPEC/  
17- REV 00

Page 7 of 10

HYDERABAD

manufacturer and shall apply it as per the instructions. For all frames supplied by either the Owner or the contractor, mastic shall be supplied by the contractor and caulking done properly as per drawings, specifications and as per instructions of the Engineer.

Door shutters, partitions hardware fixtures etc., shall be fixed only after major equipments have been installed rooms.

Wherever required nylon cords of approved quality shall be supplied along with pivoted sashes and shall be of adequate length to terminate one meters from the floor. Lose ends of cords shall end in metal or plastic pull as approved by the Engineer.

### **3.0.0 ACCEPTANCE CRITERIA**

#### **3.1.0 For fabricated items**

- a) Over all dimensions shall be within  $\pm 1.5$  mm of the size shown on drawings.
- b) Mullions, transoms etc., shall be in one length and permissible deviations from straightness shall be limited to  $\pm 1.5$  mm from the axis of the member.
- c) Door and window shutters shall operate without jamming. The clearance at head and jamb for door shutters shall not exceed 1.5 mm. For double leaf doors, the gap at the meeting stiles shall not be more than 1.5 mm.
- d) Door leaves shall be under cut where shown on drawings.
- e) Doors, windows, frames, etc., shall be on a true planes, free from warp or buckle.
- f) All welds shall be dress flush on exposed and contact surfaces.
- g) Correctness of location and smoothness of operations of all shop installed hardware and fixtures.
- h) Provision for hardware and fixtures to be at site.
- i) Glazing beads shall be cut with mired corners.
- j) Glazing clips, fixing devices etc., shall be supplied in adequate numbers.
- k) Shop coats shall be properly applied.



**STANDARD TECHNICAL  
SPECIFICATION FOR METAL DOORS,  
WINDOWS, VENTILATORS, LOUVERS  
ETC.**

PEDC/STD.SPEC/  
17- REV 00

Page 8 of 10

HYDERABAD

- l) Exposed aluminum surfaces shall be free scratches, stains, and discoloration. Anodized surfaces shall present a uniform and pleasing look.

**3.2.0 For installed Items**

- a) Installation shall be at correct location , elevation and general, on a true vertical plane
- b) Fixing details shall be strictly as shown on drawings.
- c) Assembly of composite units shall be strictly as drawings with mastic caulking of transoms and mullions, gaskets, weather strips etc., complete.
- d) All frames on external walls shall be mastic caulked to prevent leakage through joint between frames and masonry.
- e) All openble section shall operate smoothly without jamming.
- f) Locks, fasteners etc., shall engage positively keys shall be non-inter changeable.
- g) Cutting to concrete or masonry shall be made good and abrasions to shop paint shall be touched up with paint of same quality as shop paint.
- h) Aluminum doors, windows, etc., shall be free from scratches, stain or discoloration.

**4.0.0 INFORMATION TO BE SUBMITTED**

**4.1.0 With Tender**

- a) Names of manufacturers for doors, windows etc.,
- b) Manufacturer's catalogue for all hardware and fixtures proposed to be used.

**4.2.0 After Award**

- a) Before starting fabrication of all metal doors, etc., the contractor shall submitted detailed fabrication drawings to the engineer for approval. The fabrication shall be started only after approval of drawings.



**STANDARD TECHNICAL  
SPECIFICATION FOR METAL DOORS,  
WINDOWS, VENTILATORS, LOUVERS  
ETC.**

PEDC/STD.SPEC/  
17- REV 00

Page 9 of 10

HYDERABAD

- b) He shall submit a program of work to be done for the approval of the Engineer.
- c) Before bulk supply he shall submit for the approval of Engineer samples of all bought out items and samples of each type of fabricated items. The samples shall be retained by the Engineer for comparison of bulk supply and returned to contractor towards the end for final incorporation in the job.

**5.0.0 RATES**

Rates shall be unit rates for the complete work including supply installation and painting. All mullions and transoms, vision panels, louvers to doors, glass and glazing including glazing beds, weather stripping, fixing devices hinges, aldrops, lower bolts, mortise locks etc., shall be included in the rates. The rates shall also including cutting and/or grouting to concrete and jamming of frames and making good concrete and masonry and other related work. Only items specifically mentioned under 6.0.0 or in the Schedule of items shall be separately measured.

**6.0.0 METHOD OF MEASUREMENT**

- a) Supply and installation including painting of doors shall be measured in m<sup>2</sup>. The types shall be as shown on drawings and described in Schedule of Items.
- b) Supply and installation including painting of windows shall be measured in m<sup>2</sup>.
- c) Supply and installation including painting of louvers shall be measured for area of opening in which the louver is to be installed.
- d) Insulation between door faces shall be measured for actual area and paid separately over the basic rate doors.
- e) Door closures shall be measured in actual numbers used, if not specifically included in the description of door item in the schedule.

**7.0.0 I.S.CODES**

Following are some of the important I.S Codes as relevant to this section :

Steel doors, windows and ventilators	-	IS : 1038
Steel windows for industrial buildings	-	IS : 1361



**STANDARD TECHNICAL  
SPECIFICATION FOR METAL DOORS,  
WINDOWS, VENTILATORS, LOUVERS  
ETC.**

PEDC/STD.SPEC/  
17- REV 00

Page 10 of 10

**HYDERABAD**

Aluminum doors windows and ventilators	-	IS : 1948
Aluminum windows for industrial buildings	-	IS : 1949
Steel door frames	-	IS : 4351
Code of practice for fixing and glazing of metal (Steel and aluminum doors windows ventilators.	-	IS : 1081



HYDERABAD

**STANDARD TECHNICAL  
SPECIFICATION FOR ROLLING STEEL  
SHUTTERS AND GRILLS**

PEDC/STD.SPEC/18-  
REV 00

Page 1 of 4

**ROLLING STEEL SHUTTERS  
AND GRILLS**

REV. NO.	PRAPARED	APPROVED	DATE

**COPYRIGHT AND CONFIDENTIAL**

The information on this document is the property of BHARAT HEVY ELECTRICAL LTD.It must not be used directly or indirectly in any way detrimental to the interest of the Company.



# STANDARD TECHNICAL SPECIFICATION FOR ROLLING STEEL SHUTTERS AND GRILLS

PEDC/STD.SPEC/18-  
REV 00

Page 2 of 4

HYDERABAD

## 1.0 SCOPE

This specification covers the design, supply of materials fabrication, delivery and erection of Rolling Shutters / Grills with motor drive and /or mechanical operation including all accessories as here in after specified.

## 2.0 INSTALLATION

### 2.1 Components

- a) Slots for rolling shutters shall be made tested bright cold rolled annealed M.S.Strips, not less then 0.9 mm thick shutters up to 3.5 M wide and above, machine rolled at 75 mm rolling centers, interlocking with each other. The profile will be such as to prevent excessive deflection under specified wind load.
- b) Rolling grills shall be constructed out of 6 mm dia. Rods at 35 mm on centers running horizontally flexible connected with vertical links spaced not more then 200 mm centers. Alternatively, rolling grills shall be made from perforated slates of approved design reinforced with 6 mm rods.
- c) End locks shall be heavy type M.C.I/C.I. and shall be provide at each end of alternate slots unless specified otherwise in the Schedule.
- d) Bottom bars shall be finished with two angles not less then 6 mm thick for external shutters. When shown on drawings, a flexible weather strip shall be applied to make tight contact with the floor.
- e) Guides shall be of such depth as to retain the shutter under a wind pressure of 100 Kg/Sq.M. or as specified in Schedule.
- f) Shafts shall be of steel pipe of sufficient size to carry the torsional load with a maximum deflection of  $1/360^{\text{th}}$  of span. Grease packed ball bearings or bushings shall be provided for smooth trouble free operation.
- g) Hoods shall be formed of not less then 20 gauge steel, suitable reinforced to prevent sag.
- h) Locks shall be slide bolt and hasp, or cylinder lock operable from one or both sides. Provision securing hand chin with pad – lock provision for removable handle for hand cranks etc., shall be made as described in Schedule or as described by the Engineer.
- i) Power unit shall be suitable for 3 phase, 50 cycle, 400 volts A.C. power supply and shall be either floor or wall mounted unit. The motor shall be of sufficient capacity to move the shutter in either direction as a speed of 0.3 meters per second. In addition to the gear motor each standard power unit shall include a



HYDERABAD

## STANDARD TECHNICAL SPECIFICATION FOR ROLLING STEEL SHUTTERS AND GRILLS

PEDC/STD.SPEC/18-  
REV 00

Page 3 of 4

magnetic brake, a reversing starter with built – in overload protection, a geared limit switch and one push button station located inside the building unless otherwise standard in Schedule or Drawings.

- j) Operating chins shall be of tested quality, heavily galvanized and with all ends rounded to assure smooth operation and hand protection.
- k) Reduction gears shall be high strength gray cast iron, machine moulded from machine out patterns.

### 2.2 Manually Operated Shutters/ Grills

Manually operated shutters shall be easily operable by one person. The speed of operation shall be about 0.3 meters per second. In general, manually operated shutters shall be push pull type for opening upto 9 Sq. meter in area. Larger shutters shall be either chain and gear operated or crank and gear operated. The crank handle shall be removable. All shutters shall be lockable from one or both side as described in Schedule or as desired by the Engineer.

### 2.3 Power Operated Shutters/Grills

These shall be operable from a push button station conveniently located beside the door or as shown on drawings. One emergency hand chin/crank operation shall also be provided for use in case of failure of the electric system. Where called for in Schedule externally mounted shutters shall be operated by control mechanism located inside the building.

### 2.4 Shop Coat

Shutters shall be painted with one coat of red lead or zinc chromate primer. Where specified, doors shall be galvanized and subsequently paints one coat of zinc chromate for adhesion of field coat.

### 2.5 Erection

Door shall be installed by the manufacturer or his authorized representative and all work shall be as per manufacturer's instructions. Any drilling or cutting to concrete, masonry etc. shall be made good after erection of shutters and all abrasion to shop coat shall be touched up. All electrical work shall be in strict accordance with the latest Indian Electricity Rules.

## 3.0 ACCEPTANCE CRITERIA

### 3.1 Shop Inspection

After completing the manufacture of the different components of the rolling shutter, an arrangement for shop inspection by the Engineer shall be made to check the conformity with approved shop drawings.



# STANDARD TECHNICAL SPECIFICATION FOR ROLLING STEEL SHUTTERS AND GRILLS

PEDC/STD.SPEC/18-  
REV 00

Page 4 of 4

HYDERABAD

## 3.2 Field Inspection

After installing the shutters, the Contractor shall test the performance of the shutter in the presence of the Engineer. The doors shall be smoothly operable under all ambient conditions. All control and locking devices shall give fault-free performance.

## 3.3 Guarantee

The Contractor shall give one year's guarantee for the successful operation of the shutter. This shall be supported by a separate and unilateral guarantee from the manufacturer of the shutters.

## 4.0 RATES

Rates shall be unit rates for complete items for supply and /or erection of rolling shutters, including all drives, accessories, hardware etc. No extra payment shall be made for cutting, drilling welding grouting etc. to structure for installation of the shutters.

The rates shall include the mounting of controls, wire and wiring from the nearest junction box, conduit and other electrical connections.

## 5.0 METHOD OF MEASUREMENT

- a) Rolling shutters or grilling shall be measured for area of opening in which they shall be installed. Attractively, shutters shall measure for actual number of different sizes used.
- b) Unless included in the main item, whether stripping at bottom bar and mullions shall be measured separately for length.
- c) Cylinder locks shall be for actual numbers used. Pad locks shall be supplied by others.

## 6.0 I.S.CODE

IS: 6248 - Metal rolling shutters and rolling grills.



**STANDARD TECHNICAL SPECIFICATION  
FOR ROOF WATER PROOFING  
INSULATION AND ALLIED WORKS**

PEDC/STD.SPEC/01  
9/ REV 00

Page 1 of 9

HYDERABAD

**ROOF WATER PROOFING  
INSULATION AND ALLIED WORKS**

REV. NO.	PRAPARED	APPROVED	DATE

**COPYRIGHT AND CONFIDENTIAL**

The information on this document is the property of BHARAT HEVY ELECTRICAL LTD.It must not be used directly or indirectly in any way detrimental to the interest of the Company.



**STANDARD TECHNICAL SPECIFICATION  
FOR ROOF WATER PROOFING  
INSULATION AND ALLIED WORKS**

PEDC/STD.SPEC/01  
9/ REV 00

Page 2 of 9

**HYDERABAD**

### 1.0.0 SCOPE

This specification covers furnishing installation, repairing finishing, curing, testing, protection, maintenance till handing over of roof water – proofing, insulation and allied works for buildings and at locations covered under the scope of the contact.

### 2.0.0 INSTALLATION

#### 2.1.0 Grading Underbed

The surface to receive the underbed shall be roughened and thoroughly cleaned with wire brush and water. Oil patches if any shall be removed with detergent. The surface shall be soaked with water and all excess water removed out before laying of the underbed.

The underbed shall not be laid under direct hot sun and shall be kept in shade immediately after laying so as to avoid quick loss of water from the mix and separation from the roof surface. The underbed shall be cured under water for at least 7 days.

The underbed shall be laid to provide an ultimate run off gradient not less than 1 in 130 and as directed by the Engineer. Upto and average thickness of 25 mm the underbed shall usually be composed of cement and sand plaster. For higher thickness the underbed shall be made with cement concrete.

The Underbed shall be finished to receive the waterproofing treatment direct or insulating of the case may be.

#### 2.1.1 Plaster

The grading plaster shall be average 25 mm thick maximum. It shall consist of cement and coarse sand in the ratio 1:4 normal by volume. The sand and cement shall be thoroughly mixed dry and then water added. Each batch of mix shall be consumed before the initial set starts.

The plaster shall be fully compacted in the desired grade in continuous operation. The surface shall be even and reasonably smooth.

#### 2.1.2 Concrete

The concrete shall be used where the sub grade is more than average 25 mm thick. It shall consist of cement concrete 1:2:4 normal mix by volume with 12 mm down stone chips and coarse sand. The aggregate shall be mixed dry and minimum quantity of water shall be added to made the mix workable.



**STANDARD TECHNICAL SPECIFICATION  
FOR ROOF WATER PROOFING  
INSULATION AND ALLIED WORKS**

PEDC/STD.SPEC/01  
9/ REV 00

Page 3 of 9

**HYDERABAD**

The mix shall be laid to proper grade, fully consolidated and surface shall be smooth and even.

**2.2.0 Insulation**

The Tendered shall along with tender send specifications of insulating materials he proposes to use and the proposed method of laying. Before bulk supply, the contractor shall send samples of insulating material to the Engineer, and after approval of the samples, the Contractor shall procure and transport the bulk material to the site. Whenever asked by the Engineer, the Contractor shall furnish test certificates from testing laboratory on the insulating and other properties of the materials.

After laying the insulation the surface shall be made ready as required to receive, the water proofing treatment. If any plastering is used of shall be not lower than of cement sand by volume and not that of 12 mm and it shall be cured for seven days.

**2.2.1 Foam Concrete**

This shall be of light weight foam concrete of average 50 mm thickness or as specified or as shown on drawings. This may be laid in situ in suitable panels or in pre cast blocks. The insulating properties shall be such that the thermal conductivity shall not exceed  $0.125 \text{ Kcl/m}^2 \text{ h degree C}$ . The weight of the insulating material shall be from  $0.3$  to  $0.5 \text{ gm/cm}^3$ .

Before starting the laying of foam concrete samples shall be prepared at site and got tested for approval of the Engineer.

The foam concrete laid shall be sufficiently strong to make the usual work load and standard loads expected on the roof. Any damaged portion shall be removed and replaced forth with. Approval of the Engineer shall be taken before laying the waterproofing over the insulation.

While laying the foam concrete, samples from each batch of the mix shall be kept for test if so desired by the Engineer.

**2.2.2 Expanded Polystyrene Blocks**

The expanded polystyrene block insulation shall be fire retardant quality and shall have a maximum thermal conductivity of  $0.26 \text{ Kcl m/m}^2 \text{ h degree C}$ . It must be strong enough to withstand without deformation the work load and standard loads expected on the roof.

The Contractor shall lay the expanded polystyrene block as per manufacturer's approved specification. Only specifically experienced workers shall be used for this work. If the



**STANDARD TECHNICAL SPECIFICATION  
FOR ROOF WATER PROOFING  
INSULATION AND ALLIED WORKS**

PEDC/STD.SPEC/01  
9/ REV 00

Page 4 of 9

**HYDERABAD**

Engineer is not satisfied about the efficiency of the workers the Contractor shall secure manufacturer's supervision at no extra cost to the Owner.

**2.3.0 Fillets**

Fillets at junction of roofs and vertical walls shall be provided with the same insulating material as provided for the main roof insulation. The fillets shall be 150 mm x 150 mm in size unless otherwise shown on drawings or instructed by the Engineer.

Where there is no insulation over roof slab, fillets shall be cast-in situ cement concrete (1:2:4) normal mix by volume.

**2.4.0 Water proofing**

Water proofing treatment shall be laid by a specialist firm with long experience in the particular trade.

**2.4.1 Bituminous Water Proofing**

The waterproofing treatment for roofs with Bitumen Felts shall be done following relevant IS:1346. Bitumen felts shall conform to IS: 1322 and Bitumen Primer to IS:3384.

The bonding materials shall consist of blown type conforming to IS:702 or residual bitumen to IS:73 or a mixture of the two to withstand local conditions of prevailing temperature or gradient of roof surface. The Contractor shall convince the Engineer that the bonding material proposed to be used is suitable for the particular job.

The Contractor shall state the source from where he proposed to procure the materials. Samples of the self finished felt shall be submitted in advance to the Engineer along with test certificates for his review. Test certificates for the bonding materials shall also be submitted and samples, if desired by the Engineer, shall be provided for confirmatory tests. Samples of pea sized gravel shall be submitted if instructed by the Engineer.

Minimum overlaps of 100 and 75 mm shall be given at the end and sides of strips of felt and properly bonded with bitumen. Joints in successive layers of felt shall be staggered.

Normal treatment with one layer of felt, heavy treatment with two layers of felt or Extra Heavy treatment with three layers of felt shall be indicated in the Schedule of items. Brief details of the various treatments shall be as follows:

a) Normal Treatment: Four courses:

- 1) Hot applied bitumen at the rate of 1.2 kg/m<sup>2</sup> Min.



**STANDARD TECHNICAL SPECIFICATION  
FOR ROOF WATER PROOFING  
INSULATION AND ALLIED WORKS**

PEDC/STD.SPEC/01  
9/ REV 00

Page 5 of 9

**HYDERABAD**

- 2) Hessian base self finished felt, type 3, grade 1.
- 3) Hot applied bitumen at the rate of 1.2 Kg/m<sup>2</sup> Min.
- 4) Pea sized gravel at the rate of 0.006 m<sup>3</sup>/m<sup>2</sup>.

**b) Heavy Treatment: Six Courses:**

With Hessian base felt

- 1) Hot applied bitumen at the rate of 1.2 kg/m<sup>2</sup> Min.
- 2) Hessian base self-finished felt, type 3, grade 1.
- 3) Hot applied bitumen at the rate of 1.2 Kg/m<sup>2</sup> Min.
- 4) Hessian base self – finished felt, type 3, grade 1.
- 5) Hot applied bitumen at the rate of 1.2 Kg/m<sup>2</sup> Min.
- 6) Pea sized gravel at the rate of 0.006 m<sup>3</sup>/m<sup>2</sup>.

Or

With fibre base felt

- 1) Hot applied bitumen at the rate of 1.2 kg/m<sup>2</sup> Min.
- 2) Fibre base self-finished felt, type 2, grade 2.
- 3) Hot applied bitumen at the rate of 1.2 Kg/m<sup>2</sup> Min.
- 4) Fibre base self-finished felt, type 2, grade 2.
- 5) Hot applied bitumen at the rate of 2.5 Kg/m<sup>2</sup> Min
- 6) Pea sized gravel at the rate of 0.008 m<sup>3</sup>/m<sup>2</sup>.

**c) Extra Heavy Treatment: Eight courses**



**STANDARD TECHNICAL SPECIFICATION  
FOR ROOF WATER PROOFING  
INSULATION AND ALLIED WORKS**

PEDC/STD.SPEC/01  
9/ REV 00

Page 6 of 9

HYDERABAD

With fibre bases felt

- 1) Hot applied bitumen at the rate of 1.2 Kg/m<sup>2</sup> Min.
- 2) Fibre base self – finished felt, type 2, grade 1.
- 3) Hot applied bitumen at the rate of 1.2 Kg/m<sup>2</sup> Min
- 4) Fibre base self-finished felt, type 2, grade 1.
- 5) Hot applied bitumen at the rate of 1.2 Kg/m<sup>2</sup> Min.
- 6) Fibre base self-finished felt, type 2, grade 1.
- 7) Hot applied bitumen at the rate of 2.5 Kg/m<sup>2</sup>
- 8) Pea sized gravel at the rate of 0.008 m<sup>3</sup>/m<sup>2</sup>.

Or

With Hessian base felt

- 1) Hot applied bitumen at the rate of 1.2 kg/m<sup>2</sup> Min
- 2) Hessian base self-finished felt, type3, grade 1.
- 3) Hot applied bitumen at the rate of 1.2 Kg/m<sup>2</sup> Min.
- 4) Hessian base self-finished felt, type 3, grade 1.
- 5) Hot applied bitumen at the rate of 1.2 Kg/m<sup>2</sup> Min.
- 6) Hessian base self-finished felt, type 3, grade 1.
- 7) Hot applied bitumen at the rate of 1.2 Kg/m<sup>2</sup>
- 8) Pea sized gravel at the rate of 0.006 m<sup>3</sup>/m<sup>2</sup>.

However, in special cases, more courses or a combination of fibre bass and Hessian base felts may be asked for

The surface to receive the waterproofing treatment must be cleaned and dried satisfactorily and the Engineer's approval taken before starting the work. If any existing



**STANDARD TECHNICAL SPECIFICATION  
FOR ROOF WATER PROOFING  
INSULATION AND ALLIED WORKS**

PEDC/STD.SPEC/01  
9/ REV 00

Page 7 of 9

HYDERABAD

water proofing treatment is being augmented the pea sized gravel or any other existing top course shall be completely removed and all damaged felts or other defects repaired.

The Engineer may instruct the Contactor to lay part of the stipulated courses at the first instance to be followed later on with the balance courses. This interim finish shall be done with hot bitumen shall be applied to start with after repair of all damages to the already laid course.

After completion the surface shall be cleaned taking care that loose gavels, felt cuttings etc., do not find their way into rain water down comers.

#### 2.4.2 Water proofing by epoxy resin based application

Exposed surfaces of cement concrete, lime concrete or brick work to be treated for waterproofing by the resin based application shall be thoroughly cleaned and the epoxy resin based material to be applied as directed by the manufacturer. The material shall not have any adverse effect on the surface on which it is applied and must stick to it uniformly to make a strong durable bond. It shall not be affected by short duration from fire, sun, light, traffic. The application shall be resistant to growth of fungus and proof against salt petre action. If desired by the Engineer, a sample shall be prepared in advance and tested for waterproofness for 48 hours under 300 mm depth of standing water. The Contractor shall arrange the demonstration by providing free the materials and labours for the application. This item shall carry a guarantee as specified under the relevant item in the Schedule.

#### 2.4.3 Flashing

Unless otherwise stated flashing shall be done in the same way as the water proofing except that the last layer, instead of being finished with pea-sized gravel, shall be finished with two coats of bituminous primer. The flashing shall be extended upto the vertical surfaces as sown on drawing. The flashing shall end in grooves in vertical walls. The grooves shall be at least 65 mm deep and caulked with waterproof mastic cement. The minimum overlap with horizontal roofing felt shall be 100 mm.

Where specified on drawings or directed by the Engineer, metal flashing shall be provided. The metal flashing shall be done as shown on the drawings. The materials shall be 18 G or 22 G.I. sheets, as specified on the drawings and / or as directed by the Engineer.

#### 3.0.0 ACCEPTANCE CRITERIA

The surface level shall be such as to allow quick draining of rains with out leaving any pool any where. The finishing course shall be fully secured and shall have an even



**STANDARD TECHNICAL SPECIFICATION  
FOR ROOF WATER PROOFING  
INSULATION AND ALLIED WORKS**

PEDC/STD.SPEC/01  
9/ REV 00

Page 8 of 9

**HYDERABAD**

density. There shall not be any bubble formation or crushed or squeezed insulation or underbed.

The Contractor shall give a guarantee in writing for all works executed under this specification supplemented by a separate and unilateral guarantee from the specified agency for the roof water-proofing treatment work. The guarantee shall be for materials and workmanship for 5 years in case of normal treatment, 10 years for heavy treatment and 20 years for extra heavy treatment. The mode of execution of the guarantee shall be acceptable to the Owner.

#### 4.0.0 RATES

Rates shall be for complete work as detailed in the specification unless any particular portion is specifically excluded in the Schedule of items.

#### 5.0.0 METHOD OF MEASUREMENT

The method of measurement for various items of works shall be in general as per IS: 1200 and in particular, as specified below:

##### 5.1.0 Garding Underbed

###### a) Plastering

- a) All plastering etc., shall be measured on actual area laid
- b) For openings, sleeves, pipes, etc., whose sides are not plastered, as deductions shall be made for openings upto 0.1 Sq.m in area each, and full deductions shall be made for openings above 0.1 Sq.M each.
- c) No extra shall be paid for finishing around openings, sleeves, pipes, ducts, inserts, etc.,
- d) Sides of plasters, projections, etc., shall be measured for actual size.
- e) No measurements shall be made for rounding and chamfering junctions, corners, etc.,

###### ii) Concrete

Actual volume of work shall be measured in Cum and deductions for openings, conduits, pipes ducts, etc., made but no deductions shall be made for openings upto 0.1 Sq.M in area shuttering shall not be paid for separately.



**STANDARD TECHNICAL SPECIFICATION  
FOR ROOF WATER PROOFING  
INSULATION AND ALLIED WORKS**

PEDC/STD.SPEC/01  
9/ REV 00

Page 9 of 9

**HYDERABAD**

**5.2.0 Insulation / Water proofing / flashing**

- a) These shall be measured on actual area laid in Sq.M. No deductions shall be made for openings, pipes, sleeves, etc., upto 0.1 Sq.M in area each
- b) If cast-in situ insulation is done, no separate payment shall be made for from work, etc.,
- c) No separate payment shall be made for laps in waterproofing flashing etc.
- d) No separate payment shall be made for finishing round roof drains.
- e) No separate payment payment shall be made for rounding, chamfering etc., of junction, corners etc.,
- f) No separate payment shall be made for cutting grooves and keying the flashing in the groove.
- g) Metal flashing shall be measured in Sq.M of finished area done.
- h) No payment shall be made for cutting, wastages, materials left over etc., which shall be the property of the Contractor.
- i) Fillets shall be measured for actual work done in R.M.
- j) No separate payment shall be made for plastering or similar items required for laying the water proofing felt.

**6.0.0 I.S CODES AND STANDARD**

- a) IS:73 : Paving Bitumen
- b) IS:702 : Industrial Bitumen
- c) IS:1203 : Methods of testing tar and bitumen
- d) IS:1322 : Bitumen felts for waterproofing and damp proofing
- e) IS:1346 : Code of practice for waterproofing of roofs with bitumen felts
- f) IS:3384 : Bitumen primer for use in water-proofing and damp proofing



HYDERABAD

# STANDARD TECHNICAL SPECIFICATION FOR FALSE CEILING

PEDC/STD.SPEC/  
20- REV 00

Page 1 of 5

## FALSE CEILING

REV. NO.	PRAPARED	APPROVED	DATE

### **COPYRIGHT AND CONFIDENTIAL**

The information on this document is the property of BHARAT HEVY ELECTRICAL LTD.It must not be used directly or indirectly in any way detrimental to the interest of the Company.



HYDERABAD

## STANDARD TECHNICAL SPECIFICATION FOR FALSE CEILING

PEDC/STD.SPEC/  
20- REV 00

Page 2 of 5

### 1.0 SCPOE

The work under this Section shall include the supply and installation of suspended ceiling using insulation/acoustic boards/plain asbestos sheet. Aluminium panels, plaster of pairs boards, 'Prespex' etc., together with the materials labour and equipment. The work shall also include providing of openings in the ceiling for lighting, air conditioning diffusers etc., as shown on drawings or instructed by the Engineer.

### 2.0 INSTALATTION

#### 2.1 Suspension system

#### 2.2 GENERAL

Suspension system shall consist of the grid supporting the ceiling panels, intermediate runner supports for the grid if any and hangers, wall angles etc., required to suspend the grid or the runners from structural walls, slabs and beams or trusses proved factory made handing system as approved by the Engineer may be used.

All member of the suspension system shall be of sufficient strength and rigidity to carry the ceiling boards or sheets in a true and level plane without exceeding a deflection of  $1/360^{\text{th}}$  of their span. All joint s in ceiling panels shall run straight and cross joint shall be at perfect right angles. Angle moulds where shown in drawings shall be suitable anchoring device. For installation including welding of the suspension system shall be included in the rate. All MS sections used for supports etc. shall be given one coat of synthetic enamel paint over a coat of red lead primer. All wood supports shall be painted with two coats of Solignum or other approved wood preservative before erection.

#### 2.1.2 METAL GRID SUSPENSION SYSTEM

Aluminium grid ceiling system shall be "Bead lock" as manufactured by W.A. BEARDSHALL AND Co or Ajit India Ltd, or approved equal, Steal grid ceiling system shall be "jolly snap Grip" as manufactured by Anil Hardboards Ltd, or approved equal.

The Contractor shall ensure that the frame to support the ceiling is designed for its structural strength to withstand the weight of ceiling boards to be fixed, live load of  $75 \text{ Kg/Cm}^2$ , and other loads such as that of air-conditioning ducts, grills, electrical wiring and lighting fixtures, thermal insulation, etc., as shown on the drawings. The Contractor shall also submit a detailed drawings to shown the grid work, sizes of grip members method of suspension position of openings for air-conditioning and lighting, access doors etc.



HYDERABAD

## STANDARD TECHNICAL SPECIFICATION FOR FALSE CEILING

PEDC/STD.SPEC/  
20- REV 00

Page 3 of 5

Angles cleats or other suitable fixing device be fixed to the structural beam or slab above for fixing of hangers Main runners shall be hung by M>S flats, angles rods or 12g or heavier galvanised tie wire hangers at maximum 1.2 m centres. Extra hangers shall be provided at light fixtures that are supported from the ceiling system. The spacing of main and cross runners shall be as shown on drawings. Turn buckles shall be provided in M.S. rods for adjustment in levels.

The cross-trees shall intersect main runners in pattern shown on drawing and positively locked together with intersection clips. All parameter areas shall have angles mouldings fixed to vertical wall surfaces and end trees shall rest on the moulding, unless otherwise shown on drawings.

As the work of false ceiling may be interconnected with the work of air-conditioning ducts and lighting, the contractor shall fully cooperate with other agencies entrusted with the above works and who may be working simultaneously. The Contractor shall provide necessary openings in the false ceiling work for air-conditioning lighting and other fixtures. Additional framing, if required for the above openings shall also be provided at no extra cost to the Owner. Removable or hinged type inspection or access trap door shall be provided at locations specified by the owner.

### 2.2. CEILING PANELS

#### 2.2.1 MATERIALS

Ceiling panels shall be of best quality materials in thickness and properties call for in the "Schedule of Item". The Contractor shall submit test certificates to the Engineer for approval before bulk supply. The Ceiling panels may be of the following types manufactured by reputed manufacturers:

- a) Plaster of Pairs boards
- b) Expanded polystyrene insulation boards
- c) Fibre insulation boards
- d) Wood particle boards
- e) Perforated Aluminium Panels
- f) Mineral wood Ceiling tiles
- g) Glass fibre reinforced polystyrene sheets
- h) Flat asbestos sheets

Acrylic plastic sheets, translucent or figured glass sheets, moulded plastic louvers, etc., if used shall be from approved manufacturers and thickness specified in schedule.

#### 2.2.2 INSTALLATIONS OF CEILING PANELS

Installation of Ceiling panels shall be strictly as per manufacturer's instruction.



## STANDARD TECHNICAL SPECIFICATION FOR FALSE CEILING

PEDC/STD.SPEC/  
20- REV 00

Page 4 of 5

HYDERABAD

For exposed grid ceiling system, the hold down clips shall be used at the rate of maximum one per 1.2 meter length of perimeter. These shall however be omitted in access panels which shall be located as per the instruction of the Engineer.

For concealed grid ceiling system, tiles shall be fixed to the supporting grid in manner shown on drawing or as specified by the manufacturer, where V joints in tiles are called for in drawings, these shall be in true lines. Where flush surface is required, the joints shall be filled with approved filler material and finished to give a neat uniform surface. Where shown on drawings and schedule finished to give a neat uniform surface. Where shown on drawings and schedule of items, 6 mm thick cement : sand (1:3) plaster shall be applied on the under surface of ceiling boards and finished in a true and even surface without undulations suitable for subsequent painting. Special care shall be taken to neatly finish the ceiling at junctions with walls, light fixtures diffusers etc.

### 3.0 SAMPLES

Samples of acoustic panels and metal suspension system components as noted below shall be submitted for Architects approval:

Acoustic panels: 3 samples approximately 300mm square each.

Suspension system: 3 short sections each of main and secondary system

### 4.0 SHOP DRAWINGS

Shop drawings shall be submitted for approval as required and approval obtained prior to delivery of ceiling components. Shop drawings shall be co-ordinated with all related work and shall shown the following information:

- a) A reflected ceiling plan of areas indicated to receive the ceiling showing electrical and mechanical features.
- b) Typical intermediate framing for support where required.
- c) Hanger fastening details
- d) Acoustical-unit support at ceiling penetrations
- e) Details of splicing methods for main and cross runners
- f) A table indicating load bearing capacity of main and cross runners.
- g) A note stating that the suspension system member furnished will not deflect more than 1/360 of a 1.2 meter span under the indicated loadings.

### 5.0 FINISHING



## STANDARD TECHNICAL SPECIFICATION FOR FALSE CEILING

PEDC/STD.SPEC/  
20- REV 00

Page 5 of 5

HYDERABAD

**5.1** It is essential that the false ceiling work should be firm and in perfect line and level and all boards free from distortion, bulge and other defects. All defective boards and other material shall be removed from site immediately and replaced, and ceiling restored to original finish to the satisfaction of the Owner.

**5.2** The workmanship expected is of the highest order. The joints for aluminium frame work shall be interlocking type so that when the cross member is in place, it cannot be lifted out.

**5.3** The fibre board ceiling shall finally be painted with two coats of fire resistant paint of approved manufacture and colour after filling all joints with painters putty.

### **6.0 RATES**

Shall be units rates complete items called for in the "Schedule of Items". No extra payment will be made for arrangement for lighting fixtures, air conditioning, diffusers, access panels, etc. The rate shall include all cutting and wastage from standard size sheets, boards, runners etc.

### **7.0 METHOD OF MEASUREMENT**

- a) Actual area of work done shall be measured.
- b) No deduction will be made for opening up to .25 sq.m . in area each.
- c) Where a rigid steel framework is required to support the ceiling, it shall be measured and paid separately under relevant item in the Schedule of Items.

### **8.0 IS CODES**

IS:2441: Code of practice for fixing ceiling coverings.



**STANDARD TECHNICAL  
SPECIFICATION FOR  
WATER SUPPLY WORKS**

PEDC/STD.SPEC/  
22- REV 00

Page 1 of 11

HYDERABAD

**WATER SUPPLY WORKS**

REV. NO.	PREPARED	APPROVED	DATE

**COPYRIGHT AND CONFIDENTIAL**

The information on this document is the property of BHARAT HEVY ELECTRICAL LTD.It must not be used directly or indirectly in any way detrimental to the interest of the Company.



# STANDARD TECHNICAL SPECIFICATION FOR WATER SUPPLY WORKS

PEDC/STD.SPEC/  
22- REV 00

Page 2 of 11

HYDERABAD

## 1.0 SCOPE

This section includes supply of all materials, labour and incidentals for water supply for residential, business and industrial and other types of buildings. The water supply system of a building or premises covers service pipes and the necessary connecting pipes, fittings, control valves and all appurtenances in or adjacent to the building or premises.

### 1.0.1 MATERIALS

All materials, fittings, fixtures and appliances shall be of the best quality conforming to relevant Indian Standard and shall be procured from approved manufactures. Unless, specifically allowed by the Engineer, the Contractor shall submit samples of fittings and fixtures which will be retained by him for comparison when bulk supplies are received at the site. Ultimate choice of type mode and manufacturer lies completely with the Engineer.

It shall be the responsibility of the Contractor to procure the materials selected by the Engineer. Hence, orders are to be placed with the manufacturers in time, so that the materials are available at the site well ahead of their requirement.

The materials brought to the site, shall be stored in a separate secured enclosure away from the building materials. Pipe threads, sockets and similar items shall be specially protected till final installation. Brass and other expensive items shall be kept under lock and key. Fragile items shall be checked thoroughly when received at the site and items found damaged shall not be retained at the site.

### 1.0.2 PIPES AND PIPE FITTINGS

Under scope of this Specification, pipes and pipe fittings may be any or a combination of the following type:

- a) Cast Iron
- b) Steel : Lined, coated with bituminous composition out coated with cement concrete or mortar or galvanised.
- c) Reinforced Concrete
- d) Prestressed Concrete
- e) Asbestos cement
- f) Lead (Not to be used for portable water)
- g) P.V.C.
- h) Cooper



# STANDARD TECHNICAL SPECIFICATION FOR WATER SUPPLY WORKS

PEDC/STD.SPEC/  
22- REV 00

Page 3 of 11

HYDERABAD

- i) Brass
- j) Wrought iron

## 1.0.3 Water Reservoirs

Water reservoirs like pressed steel tanks and G.I. tanks shall come under scope of this specification. Reservoirs made of concrete masonry of fabricated steel shall be covered by respective work specifications.

## 1.0.4 RELATED WORKS

All works, like earth work, masonry, concrete, steel work, cutting holes, chases, repairs and rectification associated directly with installation of water supply system shall come under scope of the Contractor unless specifically excluded. These works are not detailed out in this Specification.

## 1.0.5 REGULATION

This work which is required to be carried out under the scope of this section. Shall be executed by a licensed plumber only (engages by the contractor) and he shall obtain all necessary sanctions, permissions, certificates etc., from Municipal and/or other local Authorities and shall abide by the rules of such Authorities. The fee paid to the Authorities shall be reimbursed by the Owner.

## 2.0 INSTALLATION

While basis layout may be available in the drawings provided by the Owner, the details might have to be supplemented by the Contractor for approval of the Engineer.

Special attention shall be given by the Contractor to economy symmetry layout is very important. Fittings meant for operation shall be located and oriented to allow easy reach and operation, Maintenance, repairs and replacements of pipes, fittings and fixtures must be conveniently possible.

## 2.1 PIPES LINES

### 2.1.1 LAYING

In addition to fulfilling the functional requirements shall all pipelines shall be laid true to line, plumb and level. Any deviation shall need approval of the Engineer. Meticulous care shall be taken to avoid chances of airlock and water hammer.

Pipes shall be laid on continuous unyielding surface or on reliable supports at least one near each point and spacing as directed by the Engineer. The support must be strong, neat and shall have provisions for securing the pipes in every



## STANDARD TECHNICAL SPECIFICATION FOR WATER SUPPLY WORKS

PEDC/STD.SPEC/  
22- REV 00

Page 4 of 11

HYDERABAD

direction and easy maintenance. Pipes shall be encased or concealed in masonry or concrete if shown on drawing or directed by the Engineer.

### 2.1.2 BACK FLOW

The layout of pipe work shall be such that there is no possibility of back flow towards the source of supply from any eastern or appliances, whether by siphon age or otherwise. All pipe works shall be so laid of fixed and maintained as to be to remain completely water-tight, thereby avoiding waste of water damage of property and the risk of contamination of water conveyed.

### 2.1.3 CONTAMINATION.

There shall be no cross connection whatsoever between a pipe of fitting for conveying or containing whole some water and a pipe or fitting for containing impure water or water liable to contamination or of uncertain quality of water which has been used for any purpose.

No piping shall be laid or fixed so as to pass into or through any sewer, scour outlet or drain or any manhole connected there with.

### 2.1.4 UNDERGROUND PIPINGS

Underground piping shall be laid at such a depth that it is not likely to be damaged by traffic and other loads frost, where applicable.

The size and depth of the trench shall be as approved by the Engineer. Back-filling shall be done with selected fine earth, Unless otherwise permitted, in 150mm layers and carefully consolidated. Special care shall be taken while filling in the civinity of the pipe to avoid damage. Before backfilling the laid pipe shall be fully tested and approved.

Where the pipe rest on rock it may be bedded on a layer of fine selected material or concrete to avoid local point support.

The trench shall be so treated by gradient and filling in the area that it does not act as drainage channel.

### 2.1.5. CONCEALED PIPING:

Where desired by the engineer or shown on the drawings the pipes shall be concealed in masonry or concrete of the structure. The contractor may coordinate with the building contractor for leaving the chases, opening, conduits as necessary. However, the contractor will rectify if required the chases, opening, conduits, supplement and make good after laying and testing of the concealed pipelines.

### 2.1.6 JOINTING OF PIPES



HYDERABAD

## STANDARD TECHNICAL SPECIFICATION FOR WATER SUPPLY WORKS

PEDC/STD.SPEC/  
22- REV 00

Page 5 of 11

Jointing of pipes shall be completely leak proof and durable instruction of the manufacture shall be followed unless desired otherwise by the Engineer. However, usually recommended practices are stated below for guidance.

a) **Cast Iron**

i) **Spigot and Socket Joints**

**Lead joint:**

The joint is made by first caulking in clean spun vain up to depth and filling the remainder by running in mol tern lead taking care that no dross enters the joint and then thoroughly caulking the lead. The lead need not extent into the joint further than the back of the groove formed in the socket. After completing the joint it shall not be allowed to move. For rectification the joint shall. be completely redone.

ii) **Flanged Joints:**

Flanged joints shall be made jointing rings of good quality, smooth and hard compressed fibre board of thickness not lees than 1.5 mm and of such width as fit inside the circle of bolt. Diagonally opposite bolts shall be tightened in pairs in pairs and stages so that degree of all bolts in a joint are similar. Damaged gaskets shall be replaced.

b) **Steel**

Plain ended steel pipes maybe jointed by welding. Screwed and socketed joints shall be carefully tightened. Care shall be taken to remove any burr from the ends of the pipes. Jointing compound, if used, shall be lead free and approved by the Engineer.

c) **G.I Pipes**

Threads shall be cut with sharp tools, and before jointing all scales shall be removed from pipes by suitable means. The screw/thread of the pipe shall be cleaned out and the joint made by screwing the fittings after treating the thread with approved pipe jointing compound. Once a joint has been screwed up it shall not be backed off unless thread are relearned and new compound applied.

d) **Asbestos Cement Pipes**

Socket and spigot ended pipes shall be jointed by caulking with tarred gaskets and grouted with 1:3 cement sand mortar

e) **Lead**



## STANDARD TECHNICAL SPECIFICATION FOR WATER SUPPLY WORKS

PEDC/STD.SPEC/  
22- REV 00

Page 6 of 11

HYDERABAD

Lead and lead alloy pipes shall be jointed with wiped solder joints.

f) **Concrete**

Concrete pipes may be socket and spigot ended, collar or band jointed. Joint shall be effected by caulking with 1:3 cement sand mortar.

g) **P.V.C**

Manufacturer's instruction shall be followed. For heating approved equipment with adequate control shall be used.

h) **Tyton Joint**

The manufacture's instruction shall be strictly followed in making such joints. Tyton joints shall be made by push-on type specification stipulated by; the pipe manufacturer. The tools specified by the pipe manufacturer shall be used to secure the joint fully.

Where the pipe rests on rock it may be bedded on a layer of fine selected material or concrete to avoid local point support.

The trench shall be so treated by gradient and filling in the area that it does not act as a drainage channel.

### 2.1.7 PAINTING

Where mentioned in the Schedule, underground steel and cast iron pipes shall be given 2 coats of bituminous paint on the outside after laying. When painting is to be done ground G.I. pipes shall be given a coat of zinc chromate primer. C.I. and M.S. pipes shall be given one coat of lead or zinc Chromate primer. Top Coats shall be minimum 2 coats of best quality paint.

### 2.2.0 STORAGE TANK- PRESSED STEEL TANCK

Unless otherwise mentioned, water storage tanks shall be pressed steel tanks of nominal size and capacity as mentioned in the Schedule and fabricated with all flanges external, all flanges internal, or button flange internal and side flanges external, as shown on drawings or schedule of items. The fabricator shall supply 6 prints of fabrication drawings to the Engineer for prior approval showing thickness of plates, method of jointing the plates all supports, stays, gussets etc., pads, cleats etc., required for supporting the tanks shall be supplied by the manufacturer. Inlet, overflow vent pipes, manholes etc., shall be arranged and provided as shown on drawing or mentioned in the schedule. Unless otherwise specified, the outlet pipe shall be 50 mm above the bottom of the tank and there



HYDERABAD

## STANDARD TECHNICAL SPECIFICATION FOR WATER SUPPLY WORKS

PEDC/STD.SPEC/  
22- REV 00

Page 7 of 11

shall be a 150 mm free board at the top of the tank.

All tanks shall be supplied with mosquito-proof covered top with manhole not less than 450 mm diameter. Tanks deeper than 1.00 Meter shall be provided with M.S. internal access ladder adjacent to the manhole water level indicator shall be provided if asked for. Two coats of anti-coats of anti-corrosive paint over a suitable primer shall be applied to both internal and external surface of tanks paint if used shall not impact any taste or odour to water and of lead free composition.

Erection of tanks shall be in accordance with detailed drawings and manufacture's instructions, The two finishing coats of paints shall be applied to outside after erecting is complete.

### 2.2.1 G.I. WATER

G.I. water tanks shall be produced from a reputed manufacturer. The design shall be good enough to withstand the loads safely, Galvanised iron water-storage tank shall be made of minimum 2mm thick galvanised iron sheet. Plain sheets shall be fixed at the corner to angle iron frames by means 6mm rivets at 40mm pitch for tanks up to 100 liters capacity and 8mm rivets at 35mm pitch for tanks for tanks above 1,000 liters capacity. Tanks above 1,000 liters shall have 20mm. Dia. Galvanised iron stay rods, one fixed to angle framing at top and two in the body of the tank for extra strength. Holes for riveting shall be drilled and not punched white lead shall be applied to the joints before riveting.

In case it is desired by the Engineer that corner of tank should be welded instead of riveted then the sheets shall be welded to from a tank will not have angle iron frame.

Tanks shall have 400mm dia. Holes at the top with hinged covers. The covers shall be made of galvanised iron frame. The cover shall be just loose but close fitting to keep out dust and mosquito and will not be airtight. It shall be complete With likable arrangement.

Tanks shall be provided with rising main inlets of 40mm dia. Galvanised iron pipe or as shown on Drawing and 25 mm dia. G.I. overflow pipe. The rising main shall be connected to the tank with a ball valve near the top which disconnects the supply when rank is full up to the point of overflowing.

The ball valve permits the entry of water when the tanks is empty and disconnects The supply when the tank is full. It consists of a hollow floating ball made of copper, plastic or hand rubber. 110mm in diameter, attached to an arm which is so pivoted that the end near the pivot closes the orifice of the main when the ball is raised to the required height of water in the tank and opens the main as soon as the ball drops with the fall of water level as it is drawn off through the distribution pipes. The ball valves shall be fixed to the tank independent of the inlet pipe and



# STANDARD TECHNICAL SPECIFICATION FOR WATER SUPPLY WORKS

PEDC/STD.SPEC/  
22- REV 00

Page 8 of 11

HYDERABAD

1<sup>st</sup> in such a position that the body of the ball valve cannot submerge when the tank is full up to the water line. The ball valve shall be so adjusted as to limit the level of the water line. The level of the water in the tank to 75mm below the lip of the overflow pipe. Free surface shall be about 150mm above the maximum water filled level.

## 2.2 VALVE, COCKS, TAPS

All valves, stop cocks, taps etc., shall conform to relevant Indian Standard Specification and shall be of best quality from approved manufacturers. These shall be suitable for working pressures mentioned in the Schedule. Nominal size and material shall be as per schedule.

## 2.3 PROTECTION

Open end of each pipe shall be protected during installation by suitable covers of plugs so that the ends, thread. Sockets or spigot are not damaged and no foreign material can find its way into the pipe line.

Fittings and fixtures liable to be misused or stolen during the construction phase shall be fitted only before testing and handing over.

## 3.0 TESTING AND ACCEPTANCE

### 3.1 INSPECTION BEFORE INSTALLATION

All pipes, fittings, and appliance shall be inspected, before delivery at the site to see whether they conform to accepted standards. The pipes and fittings shall be inspected on site before laying and shall be sounded to disclose cracks. Any defective items shall be clearly marked as reflected and forthwith removed from the site.

### 3.2 TESTING OF MAIN AFTER LAYING

After laying and pointing, the main shall be slowly and carefully charged with water, so that all air is expelled from the main by providing a 25 mm inlet with a stop-cock, allowed to stand full of water for a few days if time permits, and then tested under pressure. The test pressure shall be  $5 \text{ kg/Cm}^2$  or double the maximum working pressure, whichever is greater. The pressure shall be applied by means of manually operated test pump, or in the case of long mains or mains of a large diameter, by a power driven test pump, provided that the pump is not left unattached. In either case due precaution shall be taken to ensure that the required test pressure is not exceeded. Pressure causes shall be accurate and shall preferably have been recalibrated before the test. The pump having been stopped, the test pressure shall maintain itself without measurable less for at least five minutes. The end of the main shall be closed by fitting a water-tight expanding plug and the plug shall be secured by struts resist the end thrust of the water pressure in the mains.



# STANDARD TECHNICAL SPECIFICATION FOR WATER SUPPLY WORKS

PEDC/STD.SPEC/  
22- REV 00

Page 9 of 11

HYDERABAD

## 3.3 TESTING OF SERVICES PIPES AND FITTINGS

The service pipes shall be slowly and carefully charged with water allowing all air to escape avoiding all shock or water hammer. The service pipe shall then be inspected under working conditions or pressure and flow when all draw-off taps are closed, the service pipes shall be absolutely water-light. All piping, fittings and appliances shall be checked for satisfactory support and protection from damage, corrosion and frost.

## 4.0 RATES

Rates shall be unit rates for the complete work as mentioned in the specification unless any particular portion is specifically excluded in Schedule of Items. If any material, fillings or fixture are provided by the Owner free, The Contractor shall have to take delivery, kept in safe custody and be responsible till fitted and handed over.

## 5.0 MEASUREMENT

For method of measurement regarding works under scope of the specification IS:1200 (part-XVI) latest edition shall be followed unless contrary to the following.

### 5.1 TRENCHES

Unless particular items are included in the schedule, no separate measurement shall be made to lead, lift, de-watering, dressing, sorting, backfilling consolidation etc., that may be required in this connection.

### 5.2 CONCRETE MASONRY

Unless particular items are included in the schedule, no separate measurement shall be made to lead, lift, de-watering, dressing, storing, backfilling, consolidation etc., that may be required in this connection.

### 5.3 SOILING

No separate measurement should be made for dressing and remaining the surface. The soiling shall be measured on cross area of the work under the item.

### 5.4 PIPE WORKS

No separate measurement shall be made for special, supports and fixtures, cutting chases, holes and rectification unless specially indicated in the Schedule of items. If the special are separately indicated in the Schedule the measurement for there shall be over and above the measurement of the pipe work as mentioned below:

The pipes of different nominal bores shall be measured separately.



# STANDARD TECHNICAL SPECIFICATION FOR WATER SUPPLY WORKS

PEDC/STD.SPEC/  
22- REV 00

Page 10 of 11

HYDERABAD

The pipes work shall be measured in inclusive of sockets specials, fittings etc., in position.

## 5.5 FIGGINGS AND FIXTURES

Measurement for fittings and fixtures where applicable shall be in number No separate measurement shall be made anchors unless they from a separate item in the Schedule.

## 5.6 CHASES, HOLES

If items for cutting and remarking of chases, holes and similar works are included in the Schedule the measurement shall be on gross length, area or volume as appropriate.

## 5.7 PAINTING

Painting pipe works shall be measured on the basis of length for different nominal diameters of pipes. Painting of steel work may be on the basis of weight or area otherwise as mentioned against the particular items.

## 5.6 I.S. CODES

Important relevant IS Codes for this Specification are listed below:

Latest editions shall always be consulted.

IS:2065 : Code for practice for water supply in buildings

IS:1172 : Code of basis requirements for water supply drainage and sanitation.

IS:1200 : Laying of water and sewer lines including accusant items.  
(pt.xvi)

IS:1239 : Specification for Mild Steel Tubes and Mild Steel Tubulars and  
(pt.I&III) other wrought steel pipe fittings (10 mm to 15mm nominal diameter)

IS:1536 : Specification for Centrifugally cast (Spun) iron pressure pipes for water gas sewage

IS:1537 : Specification for vertically cast iron pressure pipes for water, gas and sewage



HYDERABAD

## STANDARD TECHNICAL SPECIFICATION FOR WATER SUPPLY WORKS

PEDC/STD.SPEC/  
22- REV 00

Page 11 of 11

- IS:3486 : Specification for Cast iron spigot and socket drain pipes (80 mm To 250mm nominal diameter)
- IS:3589 : Specification for Electrically welded steel pipe for water, gas and sewade (200mm to 2000mm nominal diameter)
- IS:784 : Prestressed concrete pipes
- IS:458 : Concrete pipes (with or without reinforcement)
- IS:783 : Code of practice for laying of concrete pipes
- IS:1592 : Asbestos cement pressure pipes
- IS:1626 : Asbestos cement pressure pipes, gutters and fittings (Spigot and Socket type)
- IS:404 : Lead pipes
- IS:3076 : Low density polyethylene pipes for portable water supplies
- IS:4984 : High density polyethylene pipes for portable water supplies
- IS:2501 : Copper tubes for general purposes
- IS:4047 : Brass tubes for general purposes
- IS:1230 : Cast iron rain water pipes and fittings
- IS:804 : Rectangular pressed steel tanks



**STANDARD TECHNICAL  
SPECIFICATION FOR DRAINAGE AND  
SANITATION**

PEDC/STD.SPEC/  
23- REV 00

Page 1 of 17

HYDERABAD

# DRAINAGE AND SANITATION

REV. NO.	PRAPARED	APPROVED	DATE

**COPYRIGHT AND CONFIDENTIAL**

The information on this document is the property of BHARAT HEVY ELECTRICAL LTD.It must not be used directly or indirectly in any way detrimental to the interest of the Company.



# STANDARD TECHNICAL SPECIFICATION FOR DRAINAGE AND SANITATION

PEDC/STD.SPEC/  
23- REV 00

Page 2 of 17

HYDERABAD

## 1.0 SCOPE

1.1.0 This section covers the layout and construction of drains for roof water, surface water and sewage together with all fittings and fixtures and inclusive of ancillary works, such as connections, manholes, manholes and inspection chambers used within the building and from the building to the connection to a public sewer or to treatment work. Septic tank and soak pit dispersion trenches.

## 2.0.0 INSTALLATION

### 2.0.1 General

All pipe lines, Locations of fittings and fixtures, etc., shall be as per drawings or as directed by the Engineer, Correctness of lines, plumb, orientation, symmetry and levels shall be strictly ensured. All items shall be fully secured against movement in any direction and so located as to allow easy maintenance.

All pipe lines, fittings and fixtures shall be installed leak proof. When the works under scope of this specification linked up with works executed by others, the connections shall be such as to prevent any splashing or emission of foul odour and gases.

### 2.1.0 Rainwater Down corners

Rainwater down corners shall be standards Cast Iron of Asbestos Cement pipes. In case where specifically desired. M.S. pipes may also be M.S. pipes shall be painted outside with two coats or anti corrosive paints under a coat of primer.

Rainwater down corners shall run along and be secured to walls, columns etc., where desired by the Engineer these may have to be installed in chase cut in the structured . All pipes shall be wall secured and supported by adequately strong brackets. The brackets may be wrought iron clevis type, split ring type of perforated strap iron type as approved by the Engineer. For vertical runs each pipe shall hang freely on its brackets fixed just below the socket. Suitable spacer blocks shall be provided against the vertical surface to which the pipe is fixed.

All bends and junction shall be supplied with water tight clean outs.

Proof and floor drains and vard gullies shall be installed. If required by cutting into the structure and grouted with 1:2:4 cement concrete. All gutters shall be provided with removable grating.

All horizontal pipes shall have a minimum fall of 1 in 100.

### 2.1.0 Gutters

The gutters shall be made of G.I. of A.C. All gutters shall be supplied by reputable specialized firms. Each section shall be sufficiently rigid, edges and



## STANDARD TECHNICAL SPECIFICATION FOR DRAINAGE AND SANITATION

PEDC/STD.SPEC/  
23- REV 00

Page 3 of 17

HYDERABAD

corners straight and the slopes perfectly uniform G.I. gutters shall have the edges strengthened by suitable means.

Unless noted otherwise the gutters shall have a minimum fall of in 120. Adequate number of string supports shall be provided so that there is no deflection even when the gutter is full. Each point must have a support. Unless otherwise specified the supports shall be fabricated M.S. brackets. All junctions shall be thoroughly water tight. The joints may be made by riveting, bolting or soldering. All joints between successive lengths of gutters shall have an overlap of at least 5 cm. The drop in the overlap shall always be in the direction of the fall of the gutter. Ends of gutters shall be closed water tight. Junction with rainwater down corners shall be made fully watertight and secured.

### **2.2.0 Soil and Drainage Pipes**

#### **2.2.1 Gradients**

If not specified the minimum gradients of solid and drainage pipes line shall be as follows:

100 mm nominal dia: 1 in 35

150 mm nominal dia: 1 in 65

230 mm nominal dia: 1 in 120

300 mm nominal dia: 1 in 200

#### **2.3.2 Relation with water supply pipe lines**

Unless specifically cleared by the Engineer, under no circumstances shall special drainage and soil pipes be allowed to come close to water supply pipelines.

#### **2.3.3 Laying**

Each separate pipe shall be individually set for line and for level. Where lengths of sewer or drain pipes are laid in trench, properly ; painted sight rails shall be fixed across the trench at a height, equal to length of the bonding rod fixed across trench at a height, equal to length of the bonding rod to be used, above the required invert level of the drain or sewer at the point where the sight is fixed. More sight rails shall be required at manholes, change of gradient and intermediate positions if the distance for sighting is more than 50 ft. The foot of the wall of the pipe. Each pipe shall be separately and accurately boned between sight rails.

#### **2.3.3 Support and protection on Pipelines**

All pipes shall be laid with sockets leading uphill, preferably the pipe shall rest on solid and even foundations for the full length of the barrel. However, the



## STANDARD TECHNICAL SPECIFICATION FOR DRAINAGE AND SANITATION

PEDC/STD.SPEC/  
23- REV 00

Page 4 of 17

HYDERABAD

pipe manufacturer's instruction as approved by the Engineer shall be followed in the matter of support and jointing.

To achieve full and continuous support, concrete for bedding and packing is the best. Where pipes are not bedded on concrete, the floor shall be left slightly high and carefully placed so that the pipe barrels rest on undisturbed ground. If anywhere the excavation has been carried too low packing shall be done in concrete. Where laid on rock or very hard ground which cannot be easily excavated to a smooth surface, the pipes shall be laid on a cradle of fine concrete floor of gravel and crushed stone over laid with concrete or on a well consolidated gravel and crushed stone bed as desired by the Engineer. PVC or similar pipes shall be laid directly on stable soil.

The minimum support and protection for glazed stoneware pipes shall be as follows:

- a) When cover is less than 2 meter below ground level and where pipes are unavoidably exposed above ground surface, the pipes shall be completely encased or surrounded with concrete.
- b) Where pipes are laid on soft solid with the maximum water table rising above the invert of the pipe, the sewer shall be bedded on concrete.
- c) Where the pipes have to be laid on soft solid with the maximum water table rising above the invert of the pipe, but below the top of the barrel the pipe sewer shall be hunched.
- d) Where maximum water table is likely to rise above the top of the barrel or wherever the pipe is laid on soft soil the pipe sewers shall be completely encased or surrounded with concrete.

Vitrified clay pipe shall be laid on a bed of 150 mm thick cement concrete (1:3:6) nominal mix by volume.

Cast iron pipes and concrete pipes may be supported on suitable concrete or brick support, where specified. The supports shall be located close to ends. Spacing of intermediate supports shall be as decided by the Engineer, Pipes shall be secured to the supports by approved means.

Anchoring of pipes where necessary shall be achieved by suitable concrete encasing designed for the expected thrust.

### **2.3.4 Entry into Structure.**

For entry of the pipelines into any building of structure suitable conduit after the structure or sleeves shall be used. The conduits and sleeves shall be such as to allow easy repairs and replacement of the pipes when openings of chases are required to be made in the structure for entry of pipe lines, After laying of the pipeline the opening and chases shall be mended.



## STANDARD TECHNICAL SPECIFICATION FOR DRAINAGE AND SANITATION

PEDC/STD.SPEC/  
23- REV 00

Page 5 of 17

HYDERABAD

### 2.3.5 Ducts

Where solid waste and ventilating pipes are accommodated in ducts, access to cleaning areas shall be provided. Connection to drain shall be through a gully with sealed cover to guard against ingress of sewer gas, vermin or backflow.

### 2.3.6 Traps and Ventilating pipes

Pipes carrying the waste from water closets and water closets and waste water and overflow water from baths, wash basins, sinks to drains shall be trapped immediately beneath such fixtures. Traps shall have minimum water seal of 50 mm and shall be ventilated whenever such ventilation is necessary to maintain water seal of the trap.

Ventilating pipes shall be carried up vertically the drain to a height of at least 600 mm above the outer covering of the roof of the building or as shown on drawings. All vertical venting, anti – syphonage and similar pipe shall be covered on top with a cowl. The cowl shall be made of G.I. unless desired otherwise by the Engineer.

### 2.3.7 Manhole and Inspection Chambers

The maximum distance between manholes shall be 30 meter unless specially permitted otherwise. In addition, at every change of alignment gradient or diameter there shall be a manhole or inspection chamber. The distance between manhole or inspection chamber and gully chamber shall not exceed 6 meters unless desired otherwise. Manhole shall be constructed so as to be water tight under test. The bending at the sides shall be carried out in such a manner as to provide no lodgment for any splashing in case of accidental flashing of the chamber. The channel or drain at the bottom of chamber shall be plastered with 1:2 cement, sand mortar and finished smooth to the grade. The channels and drains shall be shaped and laid to provide smooth flow.

Connecting to existing sewer lines shall be through a manhole.

Manholes shall be provided with standard G.I. covers. The covers shall be close fittings so as to prevent gases from coming out. Suitable heavy duty covers shall be used where necessary as decided by the Engineer.

### 2.3.8 Cutting of Pipes

Manufacturer's instructions shall be followed for cutting of pipes where necessary. Suitable and approved tools shall be used for the cutting so as to leave surface clean and square to the axis of the pipe.

### 2.3.10 Jointing



**STANDARD TECHNICAL  
SPECIFICATION FOR DRAINAGE AND  
SANITATION**

PEDC/STD.SPEC/  
23- REV 00

Page 6 of 17

HYDERABAD

Jointing of laid pipes shall be so planned as to avoid completely any movement or strain to the joints already made. If any joint is suspected to be damaged it shall be opened out and redone.

All joints between pipes, pipes and fittings and manholes shall be gas –tight when above ground and watertight. When underground Method of jointing shall be as per instructions of the pipe and fittings manufacturer and as approved by the Engineer. However , in the absence of any instruction available from the manufacturer the methods as detailed here under shall be used.

**a) Cast Iron Pipes**

Socket and spigot pipes shall be jointed by the cast lead joints. The spigot shall be centered in the socket of the next pipe by tightly caulking in sufficient turns of tarred gasket or hemp yarn to have unfilled half the depth of socket. When the gasket or hemp yarn has been caulked tightly a jointing shall be placed round the barrel and tightened against the face of the socket to prevent air lock. Molten lead shall then be poured in to fill the remainder of the socket and caulked with suitable tools right round the joint to make up for shrinkage of the molten metal on cooling and shall be finished 3 mm behind the socket face.

Joint in cast iron pipes with special jointing arrangements like ‘Tyton’ joints etc., shall follow the instructions of the manufacturers.

In special cases if fanged joints are accepted by the Engineer the joints shall be made lead-proof by inserting approved type of rubber gaskets. The bolts shall be secured in stages to avoid uneven strain.

**b) Concrete Pipes**

Care shall be taken to place the collar centrally over the joint.

**c) Glassed Stone water Pipes**

Tarred gasket or hump yarn soaked in thick cement slurry shall first be placed round the spigot of each pipe previously laid . The pipe shall then be adjusted and fixed in the correct position and the gasket caulked tightly so as not to fill more than  $\frac{1}{4}$  of the total depth of the socket. The remainder of the socket shall be filled with a stiff mixture of cement mortar of 1:1 proportion. Then the socket is filled, a fillet shall be formed round the joint with a trowel, forming an angle of 45 deg. With the barrel of the pipe. The newly made joints shall be protected, unit set and shall be covered with damp cloth or other suitable materials.

**d) Vitrified clay Pipes**



HYDERABAD

## STANDARD TECHNICAL SPECIFICATION FOR DRAINAGE AND SANITATION

PEDC/STD.SPEC/  
23- REV 00

Page 7 of 17

The shall be made from refractory clay mixed with crushed pottery and stone and burnt at a height temperature. These shall be hard, compact and glazed to make them acid resistant and impervious, and shall be obtained from approved manufacturer.

Special care shall be taken in handing these pipes. The pipes shall not be jointed until the earth has been partly refilled over the portion of the pipe between the joint holes. Before laying the second pipe, the socket of the first pipe laid shall be thinly painted all round on the inside with cement slurry (1 part of cement and 2 parts of clean, sharp sand ). A ring of rope yarn (closely twisted heap or jute dipped in neat cement paste or tar or bitumen, shall be inserted in the socket or pipe and driven home with caulking tools. The rope shall fully encircle the spigot with a slight overlap and shall not occupy more then one fourth of the total depth of the socket. Where the spigot end of the pipe is made for receiving the gasket, it shall be wrapped with two or three turns of tarred spun, as close to the end as possible, before inserting into the socket. The joint shall then be completely filled with cement mortar (1:1 ) which shall have very little water and leveled to from a splayed fillet at a an angle of 45 degrees with the outside pipe. Special care shall be taken so that any excess mortar etc., left inside the pipe joints is neatly cleaned off immediately after each joint is made . A semi-circular wooden scrapper or a rubber disc to which a long handle is fixed could be used for this purpose.

### e) **Lead Pies**

No lead pipes shall be used unless specifically mentioned in the specification. The joints in lead pipes shall be made as wiped solder joint. The minimum and the maximum length of the wiped solder joints shall be 8 cm, and 9cm respectively. The solder shall generally consist of two parts of lead and one part of tin.

### f) **Polythylene Pipes**

The joints shall be thermo-welded or bolted as per manufacturer's instructions.

### g) **Jointing Cast Iron Pipes with Stoneware Pipes**

Where any cast iron soil pipe, ventilating pipe or trap is connected with a Stoneware or semi-vitrified waste pipe or drain communicating with a sewer, the beaded spigot end of such cast iron soil type, waste or ventilating pipe or trap shall be inserted in to a socket of such stoneware pipe or drain and the joint made with motar consisting of one part of cement and one part of clean shape sand after placing a ratted gasket or hemp yarn soaked in neat cement slurry round the joint and inserted in it by means of a caulking tool.

### h) **Jointing Stone ware with Cast Iron Pipe**



HYDERABAD

## STANDARD TECHNICAL SPECIFICATION FOR DRAINAGE AND SANITATION

PEDC/STD.SPEC/  
23- REV 00

Page 8 of 17

Where any water closet pan or earth ware trap connected to such a pan is to be jointed with a cast Iron soil socket, shall always be of a flexible nature. Such joint shall be made with admixture of bitumen and chopped asbestos fibre.

### 2.4.0 Trenches and other excavations

Width of the trench at the bottom shall be such as to provide 200 mm clearance on either side of the pipe for facility of laying and jointing.

Excavated material, shall be stacked sufficiently away from the edge of the trench and the side of the spoil bank shall not be allowed to endanger the stability of the excavation. Spoil may be carted away and used for filling the trench behind the work.

Turf, top soil or other surface materials shall be set aside, turf being carefully rolled and stacked for use in reinstatement.

All excavation shall be properly timbered, where necessary.

Efficient arrangements for dewatering during excavation and keeping it dry till backfilling shall be made to the satisfaction of the Engineer, Sumps for dewatering shall be located away from the pipe layout.

Where the excavation proceeds through roads necessary permissions shall be secured by the Contractors from the appropriate authorities.

Special care shall be taken not to damage underground services, cables etc. These when exposed shall be kept adequately supported till the trench is backfilled.

The backfilling shall be done only after the pipeline has been tested and approved by the Engineer. Special care shall be taken under and sides of the pipe during hand packing with selected material. At least 300 mm over the pipe shall also be filled with soft earth or sand. Consolidation shall be done in 150 mm layers. The surface water shall be prevented from getting into the filled up trench. Traffic shall not be inconvenienced by heaping up unduly the backfilling material to compensate future settlement. All future settlements shall be made good regularly to minimize inconvenience of traffic where applicable.

### 2.5.0 Fixtures

The Tenderer shall mention in his type and make of the fixtures he intends to enclose manufacturer's current catalogues. In the absence of any such agreement, the Engineer shall be at liberty to choose any type and make.

All fixtures and fitting shall be of approved quality and type manufactured by well known manufacturers. All items brought to the site must bear



## STANDARD TECHNICAL SPECIFICATION FOR DRAINAGE AND SANITATION

PEDC/STD.SPEC/  
23- REV 00

Page 9 of 17

HYDERABAD

identification marks of the type of the manufacturer. Procurements shall be made well in advance and inspected and approved, immediately by the Engineer. All fixtures shall be adequately protected, coved and plugged till handed over.

All fittings , gratings, fasteners, unless specified otherwise, shall be chromium plated. The connecting lead pipes and bonds shall weigh at least 3 kg per 25 mm dia. Per meter length. Where PVC or similar pipes are allowed the Contractor shall produce the test reports and convince the Engineer about their durability.

Unless specified in the contract the fixtures shall be as specified herein after.

### 2.5.1 Water closet

#### a) Raised type

It shall include glazed vitreous china basin with siphon, open front solid plastic seat and plastic cover, low level glazed stoneware flushing cistern with valve less fittings, supply connections and necessary fittings. All fittings shall be chromium plated. Colour of basin , cistern, seal and cover shall be as desired by the Engineer.

#### b) Squatting type

It shall include glazed vitreous china pan with integrated foot rests and high level cast iron flushing cistern with valve less fittings, supply connections and necessary fittings. All fittings shall be chromium plated. The foot rests shall be made of white glazed vitreous china with grooved surface. The flushing cistern shall be painted as desired by the Engineer.

### 2.5.2 Urinals

It shall consist of wall type glazed vitreous china urinals, cast iron automatic flushing cistern complete with supply connections, flush pipe PVC pipes, gratings, traps and all other necessary fittings. Automatic flushing shall be approximately once every five minutes for a number of urinals located together may be served by cistern of adequate capacity. All fittings shall be chrome plated.

### 2.5.3 Wash basin.

It shall be made of glazed vitreous china. The basin shall be flat back, wall hung by painted cast iron brackets and complete with pillar Cocks. PVC waste pipes with traps, perforated waste pipe complete with necessary fittings. All fittings, including faucets shall be chromium plated. Hot and cold mixer waste



## STANDARD TECHNICAL SPECIFICATION FOR DRAINAGE AND SANITATION

PEDC/STD.SPEC/  
23- REV 00

Page 10 of 17

HYDERABAD

chin and waste washers shall be provided where specified in the Schedule of items.

### 2.5.4 Sink

It shall be made of glazed stoneware. It shall be wall hand by painted cast iron brackets and complete with one brass faucet with nylon washers, chin, waste washers, PVT waste pipes with traps, perforated waste with necessary fittings. All fittings including facets shall be chromium plated.

### 2.5.5 Bathroom mirror

It shall be made of the best quality 6 mm thick beveled glass and produced by a reputed mirror manufacturer. It shall be wall mounted with adjustable revolving brackets. The brackets, screws and other fitting shall be chromium plated, fixed type square edged installed mirrors shall be provided where indicated and flush with the wall face.

### 2.5.6 Glass shelves

Glass shelves shall consist of 6 mm thick clear glass with guard rails and shall be wall mounted with brackets. All brackets, guard and screws shall be chromium plated.

### 2.5.7 Towel rail

Towel rail shall be 20 mm dia . chromium plated MS pipes wall mounted with steel brackets. The brackets, screws etc, shall also be chromium plated.

### 2.5.8 Soap holder

It shall be made of chromium plated strong members. The holders shall be Wall mounted with chromium plated screws.

### 2.5.9 liquid soap dispenser

It shall be round and easily revolving with removable threaded nozzle. The body, bracket for wall mounting and screw shall be chromium plated.

### 2.5.10 Toilet roll holder

It shall be made of glazed vitreous china with suitable cover cum cutter Wall mounting screws shall be chromium plated.

### 2.5.11 Installation

All plumbing fitting and fixtures shall be installation in most workman like manner by skilled workers. These shall be perfect in level, plump , plane, location and symmetry. All items shall be securely anchored to walls and floors. All cuttings in walls and floors shall be made good by the Contractor.



## STANDARD TECHNICAL SPECIFICATION FOR DRAINAGE AND SANITATION

PEDC/STD.SPEC/  
23- REV 00

Page 11 of 17

HYDERABAD

### 2.6.0 Septic tank & effluent disposal

#### 2.6.1 Septic tank

Septic tank shall consist of the tank itself with inlet and outlets there from complete with all necessary earthworks and back fitting. The details of septic tank shall be as shown on drawings. This items shall also including ventilating pipe of at least 100 mm dia whose top shall be provided with a suitable mosquito proof wire mesh and cowl. Ventilating pipe shall extend to a height of about 2 meter when the septic tank is at least 15 meter away from the nearest building and to a height of 2 meter above the top building when it is located closer then 15 meter. Ventilating pipes can be connected to the normal soil ventilating system of the building where allowed.

#### 2.6.2 Effluent Disposal

The effluent from the septic tank shall be disposed by allowing it into an open channel or a body of water if the concerned authority approves or in to a soak pit for absorption by soil or shall be allowed to be absorbed by soil through open pointed SW pipes laid in a trench filled with broken bricks.

#### 2.6.3 Soap pit

The soak pit shall be complete as shown on drawings. The pit shall be lined with stone, brick or concrete blocks set in cement mortar (1:6 ) and filled with brick bats. Inlet pipe shall be taken down to a depth of 900 mm from the top as an anti – mosquito measure.

#### 2.6.4 Open joined SW pipe/Dispersion Trenches

Minimum dia. Of the SW pipes shall be 150 mm nominal. The trench for laying the pipes shall be minimum 600 x 600 mm pipes. The joint of the pipes shall be left unsealed. The entire length of the pipe within the trench shall be buried in a 250 mm layer gravel or crushed stone of uniform size. On top of gravel/crushed stone layer is a 150 mm bed of well graded coarse aggregate. Ordinary soil is used for filling the top of trench.

#### 2.6.5 Commissioning Septic tank

After the septic tank has been proved water tight and the seawater system is checked the tank shall be filled with water to its outlet level before the sewage is let into the tank. . It shall be seeded with well-digested sludge obtained from septic tank or sludge digestion tank. In the absence of digested sludge a small quantity of decaying organic matter such as digested cow- dung may be introduced.

### 3.0.0 TESTING AND ACCEPTANCE



## STANDARD TECHNICAL SPECIFICATION FOR DRAINAGE AND SANITATION

PEDC/STD.SPEC/  
23- REV 00

Page 12 of 17

HYDERABAD

### 3.1.0 Inspection before Installtion

All pipes, fittings and fixtures shall be inspected, before delivery at to see

Whether they conform to accepted standards. The pipes shall again  
Inspected on site before laying by sounding to disclose cracks. All defective  
Items shall be clearly marked and forthwith removed from the site.

### 3.2.0 Testing of Pipelines

Comprehensive tests of all pipe lines shall be made by simulating conditions of  
use. The method of actual testes shall be decided by the Engineer. All test data  
shall be recorded and submitted to the Engineer for review and instruction. The  
Engineer's description regarding tolerance shall be final.

General guidance are given below.

#### a) Smoke test

All soil pipes, waste pipes and vent pipes and all other pipes when above  
ground shall be approved gas tight any a smoke test conducted under a  
pressure of 25 mm of water and minted for 15 minutes after all trap seals  
have been filled with water. The smoke is produced by burning oily waste  
or tar paper or similar material in the combustion chamber of a smoke  
machine. Chemical smokes are not satisfactory.

#### b) Water test

For pipes other then Cast Iron Glazed ware and concrete pipes shall be  
subjected to a test pressure of at least 1.5 m head of water at the highest  
point of the section under tests. The tolerance figure of two liters per  
centimeter of diameter per kilometer may be allowed during a period of 10  
(ten) minutes. The test shall be carried out by suitably plugging the low  
end of the drain and the ends of connections, if any , and filling the system  
with water. A knuckle bond shall be temporarily jointed in at the top end  
and a sufficient length of the vertical pipe jointed to it so as to provided  
required test head or the top end may be plugged with a connection to a  
hose ending in a funnel which could be raised or lowered till the required  
head is obtained and fixed suitably for observation.

Subsidence of test water may due to one or more of the following cases:

- a) Absorption by pipes and joints
- b) Sweating of pipes of joints
- c) Leakage at joints or from defective pipes
- d) Trapped air.



**STANDARD TECHNICAL  
SPECIFICATION FOR DRAINAGE AND  
SANITATION**

PEDC/STD.SPEC/  
23- REV 00

Page 13 of 17

HYDERABAD

Allowance shall be made for (a) by adding water until absorption has ceased and after which the test proper should commence. Any leakage and the defective part of the work shall be cut out and made good.

**For cast iron pipes**

Cast iron sewers and drains shall be tested as for glazed water and concrete pipes. The drain plug shall be suitably strutted to prevent their being forced out of the pipe during the test.

**c) For straightness**

- i) By inserting at the high end of the sewer or drain a smooth ball of a diameter 13 mm less than pipe bore. In the absence of obstruction. Such as yarn or mortar projecting through the joint, the ball will roll down the invert of the pipe end emerge at the lower end and
- ii) By means of a mirror at one end of the line and lamp at the other. If the pipe line is straight, the full circle of light may be observed. The mirror will also indicate obstruction in the barrel if the pipeline is not straight.

**3.3.0 Tasting septic tank**

The septic tank shall be tested for water tightness. It shall be filled up with water and allowed to soak for 24 hours. Then, it shall be topped up and allowed to stand again for 24 hours and loss of level recorded. The fall shall not be more than 15 mm.

**3.4.0 Fixtures etc.**

All fixtures and fitting shall be connected by water tight joints. No dripping shall be accepted.

**4.0.0 RATES**

Rates shall be unit rates for the complete work as detailed out in the Specification unless any particular portion is specifically excluded in the Schedule of Items.

If any material fittings or fixtures are provided by the Owner free, the Contractor shall have to take delivery, keep in safe custody and be responsible till fitted and handed over.

**5.0.0 MEASUREMENT**

For method of measurement regarding work under scope of this Specification IS: 1200 ( part-XVI ) shall be followed unless contrary to the following:



**STANDARD TECHNICAL  
SPECIFICATION FOR DRAINAGE AND  
SANITATION**

PEDC/STD.SPEC/  
23- REV 00

Page 14 of 17

HYDERABAD

**5.1.0 Trenches**

Unless particular items are including in the Schedule, no separate measurement shall be made for lead, lifted dewatering, dressing, storing, backfilling consolidation etc., that may be required in this connection.

**5.2.0 Concrete, masonry**

Unless lumped with other items in the Schedule the measurement shall be on gross area or volume basis as mentioned under relevant items.

**5.3.0 Pipe Work**

No separate measurement shall be made for special supports and fixtures, cutting chases, holes and rectification unless specially indicated in the Schedule of items. If the specials and separately indicated in the schedule, the measurement for these shall be over and above the measurement, of the pipe work as mentioned below:

The pipes of different nominal bores shall be measured separately. The pipe work shall be measured in length inclusive of sockets specials, fittings etc., in position.

**5.4.0 Fittings and fixtures**

Measurement for fittings and fixtures where applicable shall be in number for the complete item inclusive of anchors, brackets and fasteners required. However, in special cases anchors, brackets and similar items may be measured separately if included as such in the Schedule of items.

**5.5.0 Chases and holes**

No measurement shall be made for cutting chases, holes etc., and making good for any work within the scope of this specification and shall be inclusive.

**5.6.0 Painting**

All items likely to rust shall be painted with one coat of primer which shall not be measured separately. Where finishing coat of paints are supplied that shall be measured as indicated in the Schedule of items. Usually, painting of pipes shall be measured in length for each different nominal diameter without giving any extra allowance for specials sockets, etc.

**5.7.0 Septic tank, Soak pit**

Usually it shall be measured in number for the complete septic tank or soak pit as per drawings. All earthwork, backfilling masonry, concrete, manhole, pipes



## STANDARD TECHNICAL SPECIFICATION FOR DRAINAGE AND SANITATION

PEDC/STD.SPEC/  
23- REV 00

Page 15 of 17

HYDERABAD

and fittings including. In case, it is intended to pay for individual items the same shall be indicated in the Schedule and measured in number, length area or volume as appropriate.

### 6.0.0 CODES AND STANDARDS

#### Some of the important Codes and Standards relevant to this specification

Shall be follow : Latest editions shall always be consulted.

- IS : 1172 - Code of basic requirements for water supply drainage and Sanitation.
- IS : 1200 - Laying of water and sewer lines including appurtenant (Pt: XVI)
- IS : 1239 - Mild steel Tubes and Mild steel Tubular and other wrought (Part I & II) steel pipe fittings.
- IS : 1536 - Centrifugally cast (Spun) iron pressure pipes for water gas Sewage.
- IS : 1537 - Vertically cast iron pressure pipe for water, gas & sewage
- IS : 3486 - Cast iron spigot & socket drain pipes.
- IS : 1742 - Code of Practice for building drainage.
- IS : 5329 - Code of Practice for sanitary pipe work above ground for Buildings.
- IS : 2470 - Code of Practice for designs and construction of septic Tank for small and large installations.
- IS : 3076 - Low density polyethylene pipes for potable water supplies
- IS : 4984 - High density polyethylene pipes for potable water supplies.
- IS : 1537 - Vertically cast iron pressure pipe for water, gas & sewage
- IS : 1538 - Cast Iron fittings for pressure pipes for water, gas & sewage
- IS : 1230 - Cast Iron rain water pipes and fittings
- IS : 3889 - Centrifugally cast (spun ) iron spigot & socket soil waste and ventilating pipes, fittings and accessories



**STANDARD TECHNICAL  
SPECIFICATION FOR DRAINAGE AND  
SANITATION**

PEDC/STD.SPEC/  
23- REV 00

Page 16 of 17

HYDERABAD

- IS : 1729 - Sand cast iron spigot & socket soil, waste and ventilating pipes and accessories
- IS : 1626 - Asbestos cement building pipes, gutters and fittings ( Spigot & socket types )
- IS : 458 - Concrete pipes ( with and without reinforcement )
- IS : 783 - Code of practice of laying of concrete pipes
- IS : 784 - Prestressed Concrete pipes
- IS : 651 - Salt glazed stoneware pipes & fittings
- IS : 4127 - Code of practice of laying of glazed stoneware pipes.
- IS : 1726 - Cast Iron manhole covers & frames intended for use in drainage works
- IS : 5961 - Cast Iron gratings for drainage purposes
- IS : 5219 - 'P' & 'S' traps  
(Part I)
- IS : 771 - Glassed earth-ware sanitary appliance
- IS : 772 - general requirements of enamelled cast iron sanitary appliances
- IS : 774 - Flushing Cistern for water closets & urinals (Valueless Siphonic type)
- IS : 775 - Cast Iron brackets & supports for wash basins and sinks
- IS : 2548 - Plastic water closed seats & covers
- IS : 2527 - Code of practice for fixing rain water gutters and down-pipes for roof drainage



**STANDARD TECHNICAL  
SPECIFICATION FOR DRAINAGE AND  
SANITATION**

PEDC/STD.SPEC/  
23- REV 00

Page 17 of 17

**HYDERABAD**



**STANDARD TECHNICAL  
SPECIFICATION FOR SUPPLY AND  
LAYING R.C.C. PIPES**

PEDC/STD.SPEC/  
24- REV 00

Page 1 of 4

HYDERABAD

**SUPPLY AND LAYING R.C.C. PIPES**

REV. NO.	PRAPARED	APPROVED	DATE

**COPYRIGHT AND CONFIDENTIAL**

The information on this document is the property of BHARAT HEVY ELECTRICAL LTD.It must not be used directly or indirectly in any way detrimental to the interest of the Company.



**STANDARD TECHNICAL  
SPECIFICATION FOR SUPPLY AND  
LAYING R.C.C. PIPES**

PEDC/STD.SPEC/  
24- REV 00

Page 2 of 4

HYDERABAD

**1.0 SCOPE**

This specification covers the supply and laying of R.C.C Hume Pipes as per drawings and instruction of the Engineer. The entire work shall be carried out as per latest editions of Indian Standards IS:458 and IS:783.

**2.0 Supply of PIPES**

The Contractor shall supply the R.C.C Hume Pipes of various diameters along with complete fittings required for carrying out the work. All R.C.C Hume Pipes should conform to IS:458 and should be in a good condition. The Contractor must furnish, on being demanded by the Engineer, manufacturer's certification and/or test certificates from recognized authorities.

**3.0 ALIGNMENT, LEVELS AND GRADE**

The work shall be carried out in conformance to the alignments, levels, and grades specified in the drawings. The layout and levels shall be made by him at his own cost from one reference grid and bench mark given by the Engineer. He shall give all help in instruments, materials and men to the Engineer for checking and detailed layout and levels as and when required.

Making of reference layout and level pillars along the pipeline route and maintaining them

Upto completion of the work shall be the responsibility of the Contractor.

No extra payment shall be made for these.

**4.0 LAYING OF PIPES**

**a) General:**

The laying of R.C.C. Pipes shall conform to the Clause 9 of IS:783.

**b) Conditions for laying:**

The conditions for laying of pipes to suit the conditions at site and/or as per drawings and instructions of the Engineer shall be as classified below.

**i) Culvert Condition**

In this condition the pipe is laid under combankment and may project wholly or partly above the original ground surface.

**ii) Trench Condition**



HYDERABAD

**STANDARD TECHNICAL  
SPECIFICATION FOR SUPPLY AND  
LAYING R.C.C. PIPES**

PEDC/STD.SPEC/  
24- REV 00

Page 3 of 4

In this condition the pipe is laid in a trench excavated for the purpose. The trench shall be refilled with thoroughly tampered earth after laying and jointing of pipes in approved manner.

**iii) Open Condition**

In this condition the pipe is laid such that it projects wholly or partly above original ground surface, there being no superimposed overburden on the pipe.

**c) Bedding & Supports**

**i) Culvert Condition**

In this condition the pipes shall be laid generally on First Class Bedding” as per Clause No. 4.3. of IS:783, unless directed otherwise.

**ii) Trench Condition**

In this condition the pipes shall be laid generally on “First Class Bedding” as per Clause No.4.2.3 of IS:783, unless directed otherwise.

**iii) Concrete Cradlic Bedding**

If required by the drawing or so instructed by the Engineer, the pipes, shall be laid on Concrete cradles, conforming to Clause No.4.2.3 of IS:783 in case of trench condition and conforming to Clause 4.3.4 of IS:783 in case of culvert condition.

**iv) Open Condition**

In open condition the pipeline shall be supported over rigid pedestal constructed at intervals not greater than the length of one individual piece of pipe. As per drawings and instructions of the Engineer. In no case shall the joint between two pieces of pipe shall lie at center of the span between two supports. The pedestal shall be of rubble masonry, or brick masonry or plain/reinforced concrete with a properly shaped out top to receive the pipe.

**d) Handling of Pipes**

The pipes shall be handled with all possible care while loading, unloading, transporting and lowering them in position. The method of handling during all the stages of the work should be to the approval of the Engineer and should preferably employ mechanical means like use of chain pulley block and the like.

**e) Jointing of Pipes**



**STANDARD TECHNICAL  
SPECIFICATION FOR SUPPLY AND  
LAYING R.C.C. PIPES**

PEDC/STD.SPEC/  
24- REV 00

Page 4 of 4

HYDERABAD

The Clause 10 of IS:783 shall be applicable for jointing of pipes and every possible care shall be taken. The Contractor to ensure that the joints made are leak proof, Curing of joints shall be done for a period of 10 days. No extra payment shall be made for making and curing of joints.

**5.0 MEASUREMENT**

R.C.C. Pipes shall be measured on running meter basis and paid for at the unit rate quoted by the Contractor. The rate shall include supply, laying in position, preparation of "First Class bedding", jointing with supply of all fittings, fixtures and joint materials, complete as per drawings and schedule of items.

Payments for excavation of trenches, backfilling of trenches, making of embankments, brickwork, rubble masonry work, plain and /or reinforced concrete work in concrete cradle beddings, pedestals for pipe supports and other associated works shall be made as per relevant unit rates quoted by the Contractor in the Schedule of Items.



**STANDARD TECHNICAL  
SPECIFICATION FOR PREMOULDED  
BITUMINOUS JOINT FILLER  
AND SEALING COMPOUND**

PEDC/STD.SPEC/  
25- REV 00

Page 1 of 2

HYDERABAD

**PREMOULDED BITUMINOUS JOINT FILLER  
AND SEALING COMPOUND**

REV. NO.	PRAPARED	APPROVED	DATE

**COPYRIGHT AND CONFIDENTIAL**

The information on this document is the property of BHARAT HEVY ELECTRICAL LTD.It must not be used directly or indirectly in any way detrimental to the interest of the Company.



**STANDARD TECHNICAL  
SPECIFICATION FOR PREMOULDED  
BITUMINOUS JOINT FILLER  
AND SEALING COMPOUND**

PEDC/STD.SPEC/  
25- REV 00

Page 2 of 2

HYDERABAD

### **1.0 .0 SCOPE**

The work under this section sources supply of all materials and all operations required for sealing of joints in concrete.

### **2.0 Material**

Premoulded joint fillers shall be of non-deteriorating and resilient type conforming to IS:1833. Sealing Compound shall be of grade “B” as per IS:1834, Bitumen shall conform to IS:3384.

### **3.0 Fixing of Joint Filler**

3.1 The concrete surface shall be made clean , smooth and free from dirt or loose particles. When the surface is completely dry, a coat of hot blown bitumen conforming to IS:702 of grade 85/25 shall be given with brush or spray. When the bitumen is still hot, the premoulded joint filler fibre board shall be pressed against the surface held in position, till the time it automatically remains fixed in position. Where the joint filler has been specified in two layers, the second board will be fixed as above with a few jacking patches of bitumen between the two. After placing the filler in position, the surface of filler against which further concreting is to be done is given a coat of bitumen.

### **4.0 Filling of Joint Sealing Compound**

4.1 Before application of the sealing compound, the sides of the joints are sprayed of brushed with bitumen primer. The primer is then allowed to dry out thoroughly for at least 24 hours and then filled with a mix of 30% fine sand and 70% sealing compound by weight.

### **5.0 Measurement**

5.1 Joint filler shall be measured in square meter and sealing compound in lineal meters as per dimensions shown in drawings both correct to two decimal places.



**STANDARD TECHNICAL  
SPECIFICATION FOR DEMOLITION  
AND DISMANTLING**

PEDC/STD.SPEC/  
26- REV 00

Page 1 of 5

HYDERABAD

# DEMOLITION AND DISMANTLING

REV. NO.	PRAPARED	APPROVED	DATE

**COPYRIGHT AND CONFIDENTIAL**

The information on this document is the property of BHARAT HEVY ELECTRICAL LTD.It must not be used directly or indirectly in any way detrimental to the interest of the Company.



# STANDARD TECHNICAL SPECIFICATION FOR DEMOLITION AND DISMANTLING

PEDC/STD.SPEC/  
26- REV 00

Page 2 of 5

HYDERABAD

## 1.0 SCOPE

This specification defines the demolition, dismantling of reinforced concrete, plain concrete, brick work and structural steel work or any such other work. Any special requirement as shown or noted on the drawing shall govern provision of this specification.

## 1.1 DEMOLITION

The term demolition implies breaking up. This shall consist of demolishing whole or part of work including all relevant items as specified or shown on the drawings.

## 1.2 DISMANTLING

The term dismantling implies carefully removing without damage (up or down). This shall consist of dismantling one or more part of the buildings as specified or shown on the drawings.

## 2.0 GENERAL

### 2.1 PRECAUTIONS

- 2.1.1 All materials obtained from dismantling or demolition shall be the property of the "Owner" unless otherwise specified and shall be kept in surface custody handed over to the Engineer-in-Charge.
- 2.1.2 The demolition shall always be planned before hand and shall be done in reverse order of those in which the structure was constructed. The scheme shall be got approved from the Engineer-in-Charge before starting the work.
- 2.1.3 Necessary propping and/or under – pinning shall be provided for the safety of the adjoining work or property before dismantling and demolishing is taken up and the works shall be carried out in such a way that no damage is caused to the adjoining work or property. Whenever specified temporary enclosures or partition shall also be provided.
- 2.1.4 Necessary precautions shall be taken to keep down, dust, nuisance.
- 2.1.5 Dismantling shall be done in a systematic manner. All materials which are likely to be damaged by dropping from a height of demolishing roofs, masonry etc. shall be carefully removed first. The dismantled articles shall be passed by hand, where necessary lowered to the ground (and not thrown) and then properly stacked as directed by the Engineer – in – Charge.
- 2.1.6 Where fixing is done by nails, screws, bolts etc. dismantling shall be done by taking out the fixing with proper tools and not by tearing or ripping off.



**STANDARD TECHNICAL  
SPECIFICATION FOR DEMOLITION  
AND DISMANTLING**

PEDC/STD.SPEC/  
26- REV 00

Page 3 of 5

**HYDERABAD**

2.1.7 Any serviceable materials, obtained during dismantling or demolition, shall be separated out and stacked properly as directed by the Engineer-in Charge within a lead of 50meters. All unserviceable materials etc. shall be disposed off as directed by the Engineer-in-Charge.

2.1.8 The contractor shall maintain disconnected services whether temporary or permanent, if required.

**2.2.0 PAYMENT**

2.2.1 All works shall be measured in the decimal system, as fixed in its place, subject top  
The following limits unless otherwise stated hereinafter:-

- a. Dimensions shall be measured correct to a cm.
- b. Areas shall be worked out correct to two places of decimal.
- c. Cubic contents shall be worked out to the nearest 0.01.

2.2.2 Parts of work required to be dismantled and demolished shall be measured separately.

2.2.3 Measurement of all works except hidden work shall be taken before demolition or dismantling and no allowance for increase in bulk shall be allowed.

2.2.4 Specifications for deductions for voids, openings etc., shall be on the same basis as that employed for construction of the work.

2.2.5 The rate shall include the cost of all labour involved and tools used in demolishing including scaffolding. The rate shall also include the charges for separating out and stacking the serviceable material properly within a distance of 50 meters and disposing off unserviceable materials as directed by Engineer-in-charge.

**3.0 Roofs**

Ridges, heaps and valleys shall be girthed and included with the roof area. Corrugated or semi corrugated surfaces shall be measured flat and not girthed.

Supporting members, such as rafters, purlins, beams, joints, trusses etc. shall be measured in metric tonnes.

**4.0 Concrete and Brick Roofs and Suspended Floors**

Demolition of floors and roof of concrete or brick shall be measured in cubic



**STANDARD TECHNICAL  
SPECIFICATION FOR DEMOLITION  
AND DISMANTLING**

PEDC/STD.SPEC/  
26- REV 00

Page 4 of 5

**HYDERABAD**

meters(M) beams, cantilevers or other subsidiary supports of similar materials, shall be included in the item. In measuring thickness of roofs provided with water proofing treatments with bitumen felts, the thickness of water proofing treatment shall be ignored.

**5.0 Walls and Piers**

5.1 Taking down walls and independent piers or columns of brick stone or concrete shall be measured in cubic metres (M). All copings, corbels, cornices and other projections shall be included with the measurements.

In measuring thickness of plaster, walls, the thickness of plaster shall be ignored.

5.2 Ashlar face stones, dressed stone work, precast concrete article etc. if required to be taken down shall be so stated, and measured separately in cubic meters (m).

5.3 Cleaning bricks, stacking for measurements including all extra handling and Removed and disposing rubbish as stated shall be enumerated in the thousand of cleaned bricks.

5.4 Cleaning stone obtained from demolished/dismantled stone masonry of any Description including ashlar facing, dressed stone slabs or flanging and precast concrete blocks including all extra handling and disposing of rubbish as stated shall be measured in cubic meters (m) of cleaned stone.

5.5 Honey comb work of cavity walls of bricks , stone or concrete as solid.

**6.0 Reinforced Concrete and Brick work**

Reinforced concrete structures and reinforced brick roofs and walls shall be measured in cubic meters and square metres as specified in schedule of rates and reinforcement if required to be salvaged, shall be stated.

Where reinforcement is required to be separated, scraped and cleaned, the work shall be measured separately in metric tonnes (MT) of salvaged steel.

**7.0 Steel and Iron Work**

7.1 All steel and iron work shall be measured in metric tonnes(MT). The weight shall be computed from standard tables unless the actual weight can readily to determined.

7.2 Riveted work, where rivets are required to be cut, shall be measured.

7.3 Marking of structural steel required top be re-erected shall be measured



**STANDARD TECHNICAL  
SPECIFICATION FOR DEMOLITION  
AND DISMANTLING**

PEDC/STD.SPEC/  
26- REV 00

Page 5 of 5

**HYDERABAD**

separately.

- 7.4 In framed steel items, the weight of any covering material or filling such as iron sheets and expanded metal shall be included in the weight of the main article unless such covering is not ordered to be taken out separately.



**STANDARD TECHNICAL  
SPECIFICATION FOR TYPE AND MAKE  
OF MATERIALS TO BE USED**

PEDC/STD.SPEC/2  
7- REV 00

Page 1 of 2

HYDERABAD

**TYPE AND MAKE OF MATERIALS TO BE  
USED**

REV. NO.	PRAPARED	APPROVED	DATE

**COPYRIGHT AND CONFIDENTIAL**

The information on this document is the property of BHARAT HEVY ELECTRICAL LTD.It must not be used directly or indirectly in any way detrimental to the interest of the Company.



**STANDARD TECHNICAL  
SPECIFICATION FOR TYPE AND MAKE  
OF MATERIALS TO BE USED**

PEDC/STD.SPEC/2  
7- REV 00

Page 2 of 2

HYDERABAD

Only the following makes of materials are approved for use the contractor on this work. In case of items not listed here and also if products of listed vendors are not available in the market for some reason, advice of Project Engineering Department, BHEL, Hyderabad shall be sought for suggesting alternate vendors.

All the material shall be got approved by site incharge prior to their use

- |   |   |
|---|---|
| 1. Mortice lock                           | Godrej/Harrison   |
| 2. Hinges/tower bolt                      | ECIE/GARNISH/Everite  |
| 3. GLUE                                   | Movicol/Fevicol   |
| 4. Door Handles                           | Godrej/ECIE/HARDIMA   |
| 5. Screws                                 | Nettle Fold/Guest keen william  |
| 6. Hydraulic door closer                  | Everite/Prabhat/Garnish   |
| 7. Double action hydraulic door closer    | Everite/Prabhat/Garnish   |
| 8. Ply Wood                               | Mysore/Seastic/National/Indian Plywood  |
| 9. Teak wood                              | First class Indian Teak wood.   |
| 10. Flush door shutter                    | Sitapur/Mysore with phenol formal dehyde resin  |
| 11. Wooden panned shutter                 | 1 <sup>st</sup> class teak wood frame work with 12mm thk Nova teak/Novapan/Eco board. |
| 12. Prelaminate board                     | Novapan/Anchor/Bhutan/Ecoboard.   |
| 13. Mirror                                | Modi/Atual/Swastic  |
| 14. Sanitary ware                         | Hidustan/Nycer/Parry/Classica   |
| 15. Plumbing fixture                      | Parco,Gem.  |
| 16. False ceiling tiles                   | Nova teak/Jolly lotone/Armstrong  |
| 17. Metallic false ceiling                | Tracdek/Luxalon   |
| 18. Interior Paints                       | ICI/Berger/Asian paints/Jenson&Nicolson<br>Garware/Goodlac nerolac/ shalimar          |
| 19. Exterior water proof                  | Snowcem.  |
| 20. PVC tiles                             | Caliplast/Brite.  |
| 21. Acid proof tiles                      | Coromandel.   |
| 22. Floor tiles                           | Spartek/Kataria/Bell/Decora/Murudeshwar/<br>Regency/Cera.                             |
| 23. PVC tiles                             | Bhor.   |
| 24. Gypsum Board                          | India Gypsum/Trac.  |
| 25. Plate glass                           | Modi-Gurdian/Atual.   |
| 26. Asbestos cement sheets & accessories. | Charminar/Everest/Visakha/Ramco   |
| 27. Non shrink grout                      | Shrinkomp 30/Conbextra GP2/Pagel V12  |
| 28. MS Doors                              | Shaktimet.  |
| 29. Polymeric Waterproofing               | IWL Ltd.  |



**STANDARD TECHNICAL  
SPECIFICATION FOR FALSE  
FLOORING**

PEDC/STD.SPEC/2  
8 REV 00

Page 1 of 4

HYDERABAD

# FALSE FLOORING

REV. NO.	PRAPARED	APPROVED	DATE

**COPYRIGHT AND CONFIDENTIAL**

The information on this document is the property of BHARAT HEVY ELECTRICAL LTD.It must not be used directly or indirectly in any way detrimental to the interest of the Company.



## STANDARD TECHNICAL SPECIFICATION FOR FALSE FLOORING

PEDC/STD.SPEC/2  
8 REV 00

Page 2 of 4

HYDERABAD

### 1.0 SCOPE

This specification covers furnishing, installation, finishing, testing, protection and maintenance till handing it over of recoverable free access false flooring systems consisting of an assembly of panels mounted on adjustable pedestal and supporting steel grid system to provide an under floor space for the accommodation of flexible electrical cables and ground panels for Computer and Control room Equipment.

### 2.0 FALSE FLOORING SYSTEM

#### 2.1 Base

The system shall be placed over a base of R.C.C. Floor slab and Beams as indicated in the drawing, Any grouting etc. that is necessary to fix the supporting structure shall be done by the false flooring contractor without any additional cost to the Owner.

#### 2.2 SUPPORTING STRUCTURE

Pedestals shall be made of steel and will be of height as indicated in drawing. Pedestal shall be vertically true, located on centers to conform with size of pencil and shall be equipped with locking devices to prevent loss of finished elevation. Base of pedestal shall have integral load dispersion ribs to transmit load evenly to the base floor. Adjustment of pedestal shall be provided by threaded rod member and use of an elevating nut. The pedestal head shall prevent lateral shifting. Pedestal head shall be equipped with conducting grounding pad if so desired by Engineer-in charge. The grid channels shall be made of steel and shall be levelled to support the floor panel units.

#### 2.3 FLOOR PANELS

The floor panels be made either of steel panels, die-cast aluminium or particle board treated with fire resistant chemicals as per schedule of items. Size of each of panels shall be 600mmx600mm with all panel edges finished to a tolerance of  $\pm 0.2$ mm. All panels shall be completely interchangeable and easily removable with a suction lift tool, Panel shall be square to within a tolerance of  $\pm 0.25$ mm on the diagram.

#### 2.4 STRENGTH

Each 600mm x 600mm floor panel must be capable of supporting an uniform live minimum load load of 1220 kg/sq.M. or a contracted minimum load of 460kg applied through a phenolic caster 75mm in diameter and 45mm. Wide, or rolling minimum load of 460Kg. At any point with a maximum deflection of 2mm. The ultimate strength shall provide a 3.0 safety factor. Each pedestal shall be capable of carrying a 2,300 Kg. Axial without deformation of any part.

One additional pedestal shall be provided under floor stringer along front panel area of each control board for taking possible additional load that may occur from time to time.



## STANDARD TECHNICAL SPECIFICATION FOR FALSE FLOORING

PEDC/STD.SPEC/2  
8 REV 00

Page 3 of 4

HYDERABAD

### 2.5 SURFACE FINISH

All removable panels shall have the top surface finished with either « Decomet » polymer flooring 2mm. Thick or BHOR vinyl flooring 2mm thick or 2mm thick, ‘ Micalam’ double wear high pressure fire resistance décorative laminate bonded to the surface with compatible high creep resistant adhesive.

### 2.6 SKIRTING

Skirting shall be 150mm high and 2mm thick, completely matching with the false flooring surface finish materials and fixed to the wall surface as per manufacturers installation instructions.

### 2.7 INSTALLATION

The concrete sub floor shall be sealed with two coats of polyurethane paint to prevent moisture for contacting cables and to minimise dust problem.

Any damage to the sub floor during installation of the false flooring system shall be made good by the Contractor without any extra cost to Owner.

All steel surface are to be protected by two coats of polyurethane paint over a compatible primer and any damage to the paint during installation shall be made good. Finished floor surface, when specified by the Engineer-in-charge shall be protected by the Contractor with kraft paper taped and sealed at edges to prevent tearing. In case the loads exerted by the weight of machines are above the stated characteristics of floor covering materials, the floor shall be protected by overlaying here after during installation of machine or equipment. Such hard board shall be supplied by the Owner.

All installation work of good flooring system shall be supervised by the manufacturer's representative.

### 3.0 ACCEPTANCE CRITERIA

The false flooring system shall be checked specially for :

- a) Level.
- b) Alignment of joints.
- c) Thickness of joints.
- d) Surface finish.
- e) Colour and texture.
- f) Details at edges junctions.
- g) Performance.
- h) Criteria specified for strength.



**STANDARD TECHNICAL  
SPECIFICATION FOR FALSE  
FLOORING**

PEDC/STD.SPEC/2  
8 REV 00

Page 4 of 4

HYDERABAD

**4.0 I.S. CODES**

Important codes applied to this section are :

IS : 2571 : Code of practice for laying in situ concrete flooring.

IS : 3461 : 7 VC ( vinyl) asbestos floor tiles.

IS : 5310 : Code of practice for laying of flexible PVC sheet and tile flooring.

IS : 2046 : Specification for Decorative Thermosetting Synthetic Resin Bonded Laminated sheets.

**5.0 METHOD OF MEASUREMENT**

5.1 Actual area of work done shall be measured

5.2 No deduction shall be made for openings upto 0.25 sq.m in area each.



**TECHNICAL SPECIFICATION  
FOR PILING.**

PAGE 1 OF 7

**RUBBLE MASONRY**

REV. NO.	DATE	APPROVED

**COPYRIGHT AND CONFIDENTIAL**  
The information on this document is the property of BHARAT HEVY ELECTRICAL LTD. It must not be used directly or indirectly in any way detrimental to the interest of the Company.

Issued PED HYD	RAV.	DATE:
Prepared:	Approved:	Date:

**1. Random rubble Masonry :**

**1.1 Stone :**

Stone shall be of approved quality . it shall be sound, uniform in colour and free from decay and weathering. Stone with round surface shall not be used. Unless otherwise approved stones from one single quarry shall be used for any one work

**1.2** Stone shall be hammer- dressed on the face and side. The ‘busing’ on the face shall not project more then 20 mm on an exposed face and 15 mm on the face to be plastered.

**1.3 Mortar:**

The mortar to be used for jointing shall be as specified on the schedule of rates.

**1.4 Laying :**

All stones shall be wetted before use. They may laid at random without being brought up to any level except at plinth, window sills and roof level and top legal in case of compound wall. The bond shall be obtained by fitting in closely the adjacent stones and by using bound stones. Face stones shall extend and bond well in to the backing . proper breaking of joints shall be done. Their height shall not be grater then the breadth at that face or the depth inward. Interior filling of carefully laid, hammered down with a wooden mallet into position and solidly bedded in mortar. No hollow space shall be left anywhere in the masonry. Chips not more then 20% of quality of stones in hearting wherever necessary to avoid thick upward about 50 to 200 mm shall be firmly embedded to from a bond between successive courses. The masonry in a structure shall be carried regularly.

**1.5 Bond Stone :**

Bond or through stone running right through the thickness of wall shall be provided in the walls having thickness upto 60 mm. If the walls are thick then 600 mm, two or more bond stones overlapping each other by at least 150 mm shall be stones shall be provided for every 0.5 sq.m. of wall surface.

**1.6 Quoins :**

The quoins shall be of selected stones neatly dressed to the required angle and shall be of the same height as the course in which they occur and laid header and stretcher alternately. No quoin stone shall be less then 0.03 Cu.M.

**1.7 Joints :**

Stones all be so laid that all joints are full of mortar. Face joints shall vary from 12 mm to 25 mm thick, but not less then 12 mm. Joints shall be struck/flush/and finished with C.M. : 3 at the time of laying when plastering and pointing is not required. Joings shall be raked to a depth of 20 mm during construction, if walls

are to be plastered or pointed. For the faces of walls which are not to be plastered stone surfaces shall be cleared of mortar dropping to give uniform appearance.

**1.8 Curing**

Green work shall be protected front rain by suitable coverage. Masonry work shall be kept constantly wet for a minimum perior of 10 days.

**1.9 payments :**

Stone masonry shall be measured in cubic metres (m<sup>3</sup> ). The rate shall include cost of all operations involved at all the stages of work.

**2.0 Exposed Coursed Rubbic Masonry:**

**2.1 Stone :**

Stone shall be type specified. It shall be hard, sound and free from decay and weathering.

**2.2 Dressing:**

Face stone shall be hammer dressed and to be squared on all sides and joints so as to give them ret angular block shape. The bed joint shall be rough chisel dressed, true and 'Squares' for the least 75 mm back from the face and the side joints for at least 40 mm, such that no portion of the dressed surface is more then 6mm from a straight edge placed on it. The "Bushing " on the face shall not project more then 40 mm on exposed face.

**2.3 Mortar:**

The mortar to be used for jointing shall be as specified in schedule of rates.

**2.4 Laying:**

All stones shall be wetted before use. The stones shall be laid in horizontal courses and each course shall be of equal height.

Into the work for length not less then twice their height. The hearting or interior filling of the wall shall consist of flat bedded stones carefully laid on their proper beds solidly bedded in mortar. Chips not more then 10% of quantity of stone masonry may be used where necessary to fill interstices between adjacent stones to avoid thick beds or joints of mortar.

The mensonry in structure shall be carried up regularly, but where breaks are unavoidable, the joint shall be raked at an angle not exceeding 45. teething shall not be allowed.

**2.5 Bond Stone :**

Same as for random masonry given under para 1.5 except that a bond stone or a set of bond stones shall be inserted 1.5 m apart, in every course.

**2.6 Quoins :**

The quoins shall be of the same height as the course in which they occur, shall be formed of stones at least 0.5m long, laid stretcher and header alternately They shall be laid square on their beds, which shall be rough chisel dressed to depth of at least 100 mm.

**2.7 Jointing & Pointing :**

All bed joints shall be horizontal and all side joints vertical. All joints shall be full of mortar. Face joints shall not be more than 12 mm thick unless otherwise specified. The joint shall be either flush or struck with c.m. 1:3. Raised or cut pointing if specified in items, shall be done with c.m. 1:3 using wooden mould/template of minimum 12mm depth for uniformity.

**2.8 Curing :**

Same as per "Random Rubble" given in para 1.8.

**2.9 Payment :**

Same as for "Random Rubble" given in para 1.9.



**STANDARD TECHNICAL  
SPECIFICATION FOR CHAIN LINK  
FENCING**

PEDC/STD.SPEC/3  
2 REV 00

Page 1 of 3

HYDERABAD

**CHAIN LINK FENCING**

REV. NO.	PRAPARED	APPROVED	DATE

**COPYRIGHT AND CONFIDENTIAL**

The information on this document is the property of BHARAT HEVY ELECTRICAL LTD.It must not be used directly or indirectly in any way detrimental to the interest of the Company.



**STANDARD TECHNICAL  
SPECIFICATION FOR CHAIN LINK  
FENCING**

PEDC/STD.SPEC/3  
2 REV 00

Page 2 of 3

HYDERABAD

**INDEX**

<b>CLAUSE</b>	<b>DESCRIPTION</b>	<b>PAGE</b>
1.0.0	SCOPE	F : BC 31 :1
2.0.0	METERIAL	F : BC 31 :1
3.0.0	FIXING	F : BC 31 :1
4.0.0	RATE	F : BC 31 :1
5.0.0	MESUREMENTS	F : BC 31 :2
6.0.0	CODES AND STANDARDS	F : BC 31 :2



**STANDARD TECHNICAL  
SPECIFICATION FOR CHAIN LINK  
FENCING**

PEDC/STD.SPEC/3  
2 REV 00

Page 3 of 3

HYDERABAD

**1.0.0 SCOPE**

The work under this specification covers the supply and fixing of galvanised steel chain link fencing with galvanised steel posts and chain link fabric.

**2.0.0 MATERIAL**

The fencing shall consist of 80 mm 50 mm nominal diameter galvanised steel pipe posts, galvanised steel chain link fabric and galvanised steel binding wires. The galvanised steel chain link fabric shall conform to IS 2721. The mesh size of fabric shall be 50 mm. The diameter of mesh wire and line wire shall be 3.15 mm and 4.0 mm respectively. 1'6 gauge galvanised wires shall be used for binding the fabric to the stretched bars and posts. The pipe posts shall conform to IS: 1161 and shall be of medium grade and galvanised.

**3.0.0 FIXING**

The GI pipe posts shall be embedded in plain cement concrete not leaner than 1:4. 8 foundations. The height of posts above top of foundations and spacing of post shall not be more than 3 m. the chain link fabric shall be fixed to the fencing posts with the help of stretcher galvanised bars (25 X 6 flats) which will be bolted to the lugs welded to the post. The stretcher bars shall be provided in the lapping of fabric also.

**4.0.0 RATE**

The rate for fencing shall include the cost of labour and all materials such as fabric. GI stretcher bars, line wires, fabric bolts, nuts, binding wires, involved.



**TECHNICAL SPECIFICATION  
FOR PILING.**

**BC : 16 : SHEETING WORK IN ROOF AND SIDING**

REV. NO.	DATE	APPROVED

**COPYRIGHT AND CONFIDENTIAL**  
The information on this document is the property of BHARAT HEVY ELECTRICAL LTD. It must not be used directly or indirectly in any way detrimental to the interest of the Company.

Issued PED HYD	RAV.	DATE:
Prepared:	Approved:	Date:

**INDEX**

<b><u>CLAUSE</u></b>	<b><u>DESCRIPTION</u></b>	<b><u>PAGE</u></b>
1.0.0	SCOPE	F : BC 16 : 1
2.0.0	METERIAL	F : BC 16 : 1
3.0.0	INSTALLATION	F : BC 16 : 2
3.1.0	Storage of Materials	F : BC 16 : 2
3.2.0	Work man ship	F : BC 6 : 2
4.0.0	SAMPELS	F : BC 61: 3
5.0.0	ACCEPTANCE CRITERIA	F : BC 61: 3
6.0.0	RATES	F : BC 61: 3
7.0.0	METHOD OF MEASUREMENT	F : BC 61: 3
8.0.0	CODES AND STANDARDS	F : BC 61: 4

### 1.0.0 SCOPE

This specification covers the technical requirements for the furnishing of all labour, materials, supervision, tools, equipment and services necessary for or incidental to the fabrication and installation of asbestos cement, C.G.I., Fibreglass reinforced plastic roofing and siding in accordance with the drawings and as specified herein.

### 2.0.0 MATERIALS

Corrugated asbestos- cement sheets shall be composed of a combination of asbestos fibre and hydraulic cement with no more than 1 weigh percent of organic fabric.

Asbestos cement roofing and siding shall be of the following types as indicated on the Contract drawings: -

- a) Corrugated sheet
- b) Trafford sheet and
- c) 'S' Type Louvres

Corrugated asbestos-cement sheets shall be 6 mm thick unless otherwise directed by the Engineer or specified in the Schedule of Items.

Flashing shall be G.I. sheet metal, aluminium, etc.

The thickness of C.G.I. sheets vary with purlin spacings. Spacings shall not be greater then the following for the sicknesses mentioned:

Thickness of CGI sheets	Spacing of Purlins
0.63 mm 24 G	1.6 m
0.80 mm 22 G	1.8 m
1.0 mm 20 G	2.0 m
1.25 mm 18 G	2.4 m
1.60 mm 16 G	2.8 m

Fibreglass reinforced plastic sheets shall be translucent translucent or opaque as shown on drawings. These sheets be shatterproof and should not crack, chip or rot.

The sheets shall have uniform ; thickness, translucency (if specified ) and strength. The sheets shall be of approved manufacture and shall match the roofing profiles.

Wherever necessary and as shown on the drawing, caulking shall be non-hardening and non – staining type.

The Contractor shall also supply all necessary louvers special fittings, fasteners, Flashing, caulking and bituminous paint required for installation of the sheets in strict accordance with manufacturer’s instructions.

Roof & siding sheets shall be capable of withstanding 200 kg/sq.m wind loads.

### **3.0.0 INSTALLATION**

#### **3.1.0 Storage of materials**

All materials shall be stored by the Contractor in proper way to prevent any damage.

#### **3.2.0 Workmanship**

The erection shall be according to the best construction practice to give a water-tight finish to the satisfaction of the Engineer. Fixing of gutters and downpipes shall be according to the relevant Indian standard specification.

Asbestos sheets of profiles as stated in the drawings shall be fixed with minimum, 150 mm end lap and side laps as per manufacturer’s specification Unless otherwise specified in the drawing hook bolts or j-bolts shall be 8mm diameter placed at 300 mm centres maximum. 6 mm dia galvanised iron seam bolt and nut with G.I. flat washers and bitumen washers shall be used for stitching ridge cappings, corner pieces, Ventilators, north light curves, etc.

##### a) C.G.I.Sheeting

Side laps shall be 2 corrugations for roof and one corrugation for side sheeting .end laps shall be minimum 150 mm for roof and 100 mm for side sheeting. In ridges and hips where plain sheets are used, the end laps shall be minimum 100 mm. Holes in C.G.I. sheets shall preferably be made on the ground; the sheets should be placed on trestles and holes punched in the ridge of the corrugation from the outside inward for obtaining proper seating of limpet washers. Sheets shall be secured to sheet framing by 8 mm dia. Galvanised iron hooks or j-bolts and maximum 305 mm apart. the length of the hook of j-bolts shall be to suit the sections of the bearers. Sheets shall also be bolted at the ends at every third corrugation with 6 mm dia. Galvanised iron seam bolts and G.I. flat washers and bituminous washers.

##### b) Fibreglass reinforced plastic Sheeting

These shall be of thickness and profile as mentioned in the Schedule of Items. Colour and light transmittance shall be as mentioned on drawings and or Schedules. Where used in conjunction with C.G.I. or Asbestos Sheeting, the end and side laps and fixing device shall be same as used for

general sheeting. Where used in lieu of glass, the fixing shall be by means of timber or metal glazing beads as completely watertight and able to withstand the designed wind-pressure as mentioned in schedule.

**4.0.0 SAMPLES**

Samples of different types of sheets with method of fastening shall be submitted for approval.

**5.0.0 ACCEPTANCE CRITERIA**

The Installation shall present a neat appearance and shall be checked for watertightness. The following shall be checked.

- a) Side and end laps
- b) Absence of cracks, holes or damages of sheet
- c) Spacing of bolts
- d) Provision of double washers (G.I. and asbestos or bituminous washers)
- e) Proper installation of flashings., etc.

**6.0.0 RATES**

Rates shall be unit rate for complete item described in the Schedule of Items including all wastages.

**7.0.0 METHOD OF MEASUREMENT**

- a) No allowance shall be made for laps.
- b) Roofing and side sheeting shall be measured for flat area of work done. Corrugated or trapezoidal sheeting shall be measured flat and not girthed. Openings less than 0.1 sq.m. shall not be deducted.
- c) Special features like flashings, ridge pieces, corner pieces, north-light curves, etc. shall be length of installation.
- d) Gutters and downcomers shall be measured for length along their centre lines and bends, junctions, shoes, ends, etc. shall not be paid separately.
- e) S-type asbestos louvers shall be measured for area of opening for which it is installed.
- f) Curved asbestos roofing sheets shall be measured for area of curve.
- g) Asbestos ventilators, roof lights, etc. shall be measured for actual numbers used.
- h) Structural supports to sheeting work shall be measured and paid separately under relevant item.

- i) Glazing to asbestos roof lights shall be measured and paid separately.

**8.0.0 CODES AND STANDARDS**

The following are some of the important I.S. codes relevant to this section:-

- IS: 459 : Unreinforced corrugated and semi corrugated asbestos  
Cement sheets
- IS : 2096 : Asbestos cement flat sheets
- IS :3007 : Code of practice for laying asbestos cement sheets
- IS : 730 : Fasteners for corrugated sheet roofing.
- IS :8869 : Washers for corrugated sheet roofing.
- IS :3451 : Fibre reinforced translucent sheets.



**TECHNICAL SPECIFICATION  
FOR MISCELLANEOUS STEEL  
WORKS**

HYDERABAD

PAGE\_5 OF\_7\_

# TANK PADS

REV. NO.	DATE	APPROVED

**COPYRIGHT AND CONFIDENTIAL**  
The information on this document is the property  
of BHARAT HEVY ELECTRICAL LTD.  
It must not be used directly or indirectly in any  
way detrimental to the interest of the Company.

Issued PED HYD	RAV.	DATE:
Prepared:	Approved:	Date:



# TECHNICAL SPECIFICATION FOR MISCELLANEOUS STEEL WORKS

HYDERABAD

PAGE 5 OF 7

## 1. SCOPE

This specification description the technical requirements for the materials and construction of tank of tanks pads of sand fill or Murrum fill construction.

## 2. REFERENCE STANDAREDS

- IS 383            Aggregates – Coarse and fine, from natural sources for concrete.
- IS 2720           Part VII – Determination of water content- dry density relation using light compaction
- IS 2720           Part VIII – Determination of water content – dry density relation using heavy compaction.
- IS 2720           Part IV – Grain size analysis.
- IS 1498           Classification and identifications of soil for general Engineering purposes.

## 3. SUB GRADE PERPARATION

The surface of natural siol exposed at the bottom of excavated pit shall be throughly compacted by rolling or other means as directed by Engineer-in-Charge to obtain 90% of Max. laboratory dry density for the siol as per Is 2720 part VII.

## 4. TANK PAD CONSTRUCTION

The tank pad shall be either of sand fill or Murum fill construction as specified in construction drawings.

### 4.1 SAND FILL

Sand for filling shall be clean and well graded conforming to IS 383 with grading Zone II or III> It shall not contain any vegetable and organic materials. Sand shall be obtained from a source approved by Engineer – in – Charge.

### 4.2 SAND FILL

Sand for filling shall be clean and well graded conformings to Is : 383 with grading zone II or III. It shall not cotain any vegetable and organic materials. Sand shall be obtained from a source approved by Engineer – in – Charge. Sand shall contain an average 15% of cohesive fines such as clay (grain size less than 0.074) in natural state or artificially mixed with it. If artificially mixed, the mixture shall be subjected to through mixing to obtain a uniform mix.

### 4.3 MURRUM FILL

It shall of coarse and granual murrum containing not more than 20<sup>0</sup> Cohesive



## TECHNICAL SPECIFICATION FOR MISCELLANEOUS STEEL WORKS

HYDERABAD

PAGE\_5 OF\_7\_

finer than 0.075mm. The murrum shall be of 20 mm and covered size and shall be taken from approved qualities.

4.4 Sand murrum shall be spread in nit conceding 15cm in loose increase over than area each of these shall be uniform on density. Quality of materials and moisture content before compaction. The moisture content shall be within (2) two percent of optimum moisture content (OMC) on side OMC as per IS : 2720.

4.5 Compaction of each layers shall be done Mechanical means as per the directions of Engineer-in – Charge shall be worked manually. Each layer should be uniformly compacted to obtain 90<sup>0</sup>, of standard perfection in the material fails to achieve the required density, the layer should be renewed. With necessary alteration in the composition So that the required compaction is obtained.

4.6 Further layer shall be placed only after the layer already laid has been compacted to the required density.

4.7 The finished surface must be dressed to required grade and stops Excess material must removed from Compaction site.

### 4.8 PAYMENT

Payment for sand/Murrum filling shall be made on the basis of volume of fill, after placement and Compaction. The rate quoted should include cost of material royalties, transportation, handling compacting, watering, testing at various stages, dressing removal of surplus material and other work incidental to this.

### 5. CRUSHED ROCK RING

5.1 A crushed rock ring shall provided below the tank shall as per details given in construction drawings. The stone aggregates for the ring wall shall be 50 mm and down grade size and shall be of hard black trap, granite or such other approved materials, sand used shall be medium to coarse grade as per IS 383 and shall be clean and free organic/clayey materials.

### 5.2 LAYING

The stone aggregate shall be laid in laid layers of 150mm thickness and such shall be compacted to obtain a hard core ring wall to the satisfaction of Engineer – in – charge. The surface shall be checked from time to time during spreading and compaction to ensure a finished surface true to levels and grade as per drawings. Use of fine aggregate such as sand or finer stone aggregates may be required to fill voids and pockets, to obtain a uniform compacted hard core. Over the final compacted layer of stone aggregate sand shall be evenly spread and compacted by tamping rolling.



**TECHNICAL SPECIFICATION  
FOR MISCELLANEOUS STEEL  
WORKS**

HYDERABAD

PAGE\_5 OF\_7\_

**5.3 PAYMENT**

The rate shall include the supply of all materials, feels, labour including cutting a trench, supporting the sand suitably, during such a cutting, placing, the hard core and compacting the same to the satisfaction of Engineering- in – Charge. The payment shall be made on the cubic metre basis, with the finished cross section of the hard core.

**6.0 ANTI CORROSIVE LAYER**

6.1 Anti corrosive layer shall of succeeded coarse sand mixed with 80,100 bitumen or equivalent 8 to 10 inches by volume.

6.2 Bitumen shall be heated to a temperatur 175<sup>0</sup> C to 190<sup>0</sup> C with 3 kerosene if required and sand shall be throughly moved with in in a mixing drum to give uniform mixture and shall be laid over the compacted surface of paid in line, grade and levels as shown on the drawings, as shown on the drawings, as directed by the Engineer- in – charge Bitumem shall not be heated bryoned the temperature limits....above.

6.3 The layer shall be temped to from hard mass of uniform compacted thickness as per the schedule of items and drawings.

**6.4 PAYMENT**

The payment shall be made on Squire Meter basis of the area of layer laid on top Of Tank pads. The quoted rate shall include cost of Materials. Transportation. Mixing, Laying, Tamping finishing etc. all complete.

**7. PERMIX CARPET FOR TANKPADS**

**7.1 MATERIALS**

**7.1.1 SAND**



**TECHNICAL SPECIFICATION  
FOR MISCELLANEOUS STEEL  
WORKS**

HYDERABAD

PAGE\_5 OF\_7\_



**TECHNICAL SPECIFICATION  
FOR MISCELLANEOUS STEEL  
WORKS**

HYDERABAD

PAGE\_5 OF\_7\_



HYDERABAD

**STANDARD TECHNICAL  
SPECIFICATION FOR ANTI TERMITE  
TREATMENT**

PEDC/STD.SPEC/3  
6REV 00

Page 1 of 4

# ANTI TERMITE TREATMENT

REV. NO.	PRAPARED	APPROVED	DATE

**COPYRIGHT AND CONFIDENTIAL**

The information on this document is the property of BHARAT HEVY ELECTRICAL LTD.It must not be used directly or indirectly in any way detrimental to the interest of the Company.



HYDERABAD

**STANDARD TECHNICAL  
SPECIFICATION FOR ANTI TERMITE  
TREATMENT**

PEDC/STD.SPEC/3  
6REV 00

Page 2 of 4

**CONTENTS**

- 1.0.0 SCOPE
- 2.0 EXECUTION
  - 2.1.0 GENERAL
  - 2.2.0 CHEMICALS AND RATE OF APPLICATION
  - 2.3.0 METHOD OF TREATMENT
    - 2.3.1 TREATMENT OF COLUMN PITS, WALL TRENCHES AND BASEMENT EXCAVATIONS
    - 2.3.2 TREATMENT OF TOP SURFACE OF PLINTH FILING
    - 2.3.3 TREATMENT OF SOIL SURROUNDING PIPES AND CONDUITS
    - 2.3.4 TREATMENT OF EXPANSION JOINTS
- 3.0.0 ACCEPTANCE CRITERIA
- 4.0.0 RATES
- 5.0.0 METHOD OF MEASUREMENT
- 6.0.0 I.S. CODES



HYDERABAD

# STANDARD TECHNICAL SPECIFICATION FOR ANTI TERMITE TREATMENT

PEDC/STD.SPEC/3  
6REV 00

Page 3 of 4

## 1.0.0 SCOPE

The scope of work is to set up a chemical barrier against attack by subterranean termites while the building is under construction.

## 2.0.0 EXCAVATION

### 2.1.0 GENERAL

All work shall in general be executed as specified in IS :6313 part 11 and per approved specification of the agency having special know-how for the job.

All necessary work to ensure uniform distribution and proper penetration of treating solution shall be done according to the instruction of the engineer.

Soil treatment shall not be done when it is raining or when the soil is wet with rain or subsoil water. Once formed, the treatment soil barrier shall not be disturbed.

### 2.2.0 CHEMICAL AND RATE APPLICATION

Any of the following chemical (conforming to relevant Indian Standards) in water emulsion shall be applied by pressure pumps, uniformly over the area treated.

Chemicals	Concentration by Weight. Percentage
Dieldrin(IS :1052-1962) :	0.5
Heptachlor	0.5
Aldrim (IS :1306-1958) :	0.5
Chlodane (IS :2863-1964) :	1.0

### 2.3.0 METHOD OF TREATMENT

#### 2.3.1 Treatment of column pits. Wall Trenches and Basement Excavations.

Foundations, basements etc., may either be fully enveloped by the chemical barrier or the treatment may start 500mm below ground level. The bottom surface and sides of excavation (upto a height of about 300mm) for column pits, walls trenches and basements shall be treated with chemical at the rate of 5 liters / m<sup>2</sup> of surface area. Backfills around columns. Walls etc. Shall be treated at the rate of 15 liters / m<sup>2</sup> of the vertical surface. Chemical treatment shall be done in stages following the compaction of earth in layers. The treatment shall be carried out after the ramming operation is done by rodding the earth at 150mm centers close to the walls surface and spraying the chemicals in the specified dose.



HYDERABAD

## STANDARD TECHNICAL SPECIFICATION FOR ANTI TERMITE TREATMENT

PEDC/STD.SPEC/3  
6REV 00

Page 4 of 4

### 2.3.2 Treatment of Top Surface of Plinth Filling

Holes 50mm to 75mm deep at 150mm centers both ways shall be made crow-bars on the surface of compacted plinth fill. Chemical emulsion at the rate of 5liters/m<sup>2</sup> of surface shall be applied prior to laying soiling or sub-grade. Special care shall be taken to maintain continuity of the Chemical barrier at the junction of vertical and horizontal surface.

### 2.3.3 Treatment of soil surrounding pipes and conduits

Special care shall be taken at the points where pipes and conduits enter the building and the soil be treated for a distance of 150mm and a depth of 75mm at the point where they enter the building.

### 2.3.4 Treatment of Expansion Joints

These shall receive special attention and shall be treated in a manner approved by the Engineer.

### 3.0.0 ACCEPTANCE CRITERIA

The Contractor shall given a 10 years service guarantee in writing supplemented by a separate and unilateral guarantee from the specialised agency for the job to keep the building free of termitee for the specified period at no extra cost to the Owner.

### 4.0.0 RATES

Rates shall be lump sum rate per m<sup>2</sup> of plinth area for the complete treatment.

### 5.0.0 METHOD OF MEASUREMENT

Treatment to building shall be measured in m<sup>2</sup> of the building for the buildings where treatment has made and accepted.

No separate measurement shall be done for treatment to foundation walls of trenches, DPC at plinth level, top surface of plinth filling, treatment around pipes, etc.

### 6.0.0 I.S.CODE

Relevant code applicable for this Specification.

IS :6313 (Part II) : Code of Practice for Anti-Termite Measures in Buildings.



**STANDARD TECHNICAL  
SPECIFICATION FOR PILING PART –  
I PREAMBLE**

PEDC/STD.SPEC/4  
0 (A) REV 00

Page 1 of 2

HYDERABAD

# PILING PART – I PREAMBLE

REV. NO.	PRAPARED	APPROVED	DATE

**COPYRIGHT AND CONFIDENTIAL**

The information on this document is the property of BHARAT HEVY ELECTRICAL LTD.It must not be used directly or indirectly in any way detrimental to the interest of the Company.



**STANDARD TECHNICAL  
SPECIFICATION FOR PILING PART –  
I PREAMBLE**

PEDC/STD.SPEC/4  
0 (A) REV 00

Page 2 of 2

HYDERABAD

**1.0 GENERAL**

This part technical Specifications Covers the installation and testing of Piles forming foundations to buildings and structures.

**1.2 GENERAL REQUIREMENTS**

The construction and testing of the Piles and shall conform to the recommendations of the following :

- i) Current edition of India Standard IS : 2911- code of practice for design and construction of pile foundation.
  - a) Part I – Concrete Piles
  - b) Part II – Timber Piles
  - c) Part III – Under-reamed Piles
  - d) Part IV – Load Test on piles
- ii) BHEL Standard Specifications enclosed herewith : (Part IV to VI)
  - a) PEDC/STD.SPEC/0040(d) Material for reinforced concrete Piles.
  - b) PEDC / STD.SPEC /0040(e) Testing of Concrete Piles ‘
  - c) PEDC/STD.SPEC/0040(f) Design Construction and Installation of R.C.C Bored Cast-in-Situ Piles
- iii) General Specifications for Design, installation and Testing of Piles (enclosed-PartII)
- iv) Specification requirements for bored cast in situ uniform dia / bored / for this Project (Enclosed Part III)

In the event of any conflict between various Specifications the order of precedence will be from (iv) to (i) above.



**STANDARD TECHNICAL  
SPECIFICATION FOR PILING PART II  
- I GENERAL  
SPECIFICATIONS**

PEDC/STD.SPEC/4  
0(B)REV 00

Page 1 of 4

HYDERABAD

**PILING PART II - I GENERAL  
SPECIFICATIONS**

REV. NO.	PRAPARED	APPROVED	DATE

**COPYRIGHT AND CONFIDENTIAL**

The information on this document is the property of BHARAT HEVY ELECTRICAL LTD.It must not be used directly or indirectly in any way detrimental to the interest of the Company.



HYDERABAD

**STANDARD TECHNICAL  
SPECIFICATION FOR PILING PART II  
- I GENERAL  
SPECIFICATIONS**

PEDC/STD.SPEC/4  
0(B)REV 00

Page 2 of 4

**PART II – I GENERAL SPECIFICATIONS**

**1.0 SUBMISSIONS WITH THE TENDER**

The contractor shall submit with his tender the following information in relation to his proposals:

A) Proposed specialist Firm to undertake piling-outline data including.

- i) Name and Address of firm.
- ii) Summary or firms experience with piling system.
- iii) Key personal controlling the piling work.

B) **PLANT PROPOSED**

Number, Type and size of main Plant items to be employed on the work  
Including

- i) Cranage
- ii) Piling Equipment
- iii) Concreting Equipment

c) **QUALITY CHECKS**

Outline proposals for installation and testing of trial piles and tests on work piles.

**2.0 INITIAL PILE TESTING**

2.1 Test shall be conducted of Test Piles and work Piles as per specifications.

2.2 At least three weeks before installation of trial piles the Contractor shall submit in triplicate for the approval of the Engineer – in – charge, final of the test piling installation. These details include location, procedure for installation and testing together with list of associated equipment to be provided for construction and testing of the same.

2.3 The report on Pile testing shall be submitted within 10 days of completion of the testing of each trial Pile.

2.4 Following completion of testing of trial pile and less than Three Weeks before working Pile installation is scheduled to commence the contractor shall submit, in triplicate, for the approval of the Engineer- in – charge, report discussing the over all results of the on trial piles.



**STANDARD TECHNICAL  
SPECIFICATION FOR PILING PART II  
- I GENERAL  
SPECIFICATIONS**

PEDC/STD.SPEC/4  
0(B)REV 00

Page 3 of 4

HYDERABAD

**3.0 TECHNICAL SUPERVISION**

The contractor's site staff shall include a senior qualified and experienced engineer in attendance full time on site during piling work to be responsible for over all Technical control of the work. This person shall be fully conversant with the procedures for installation and testing of piles.

**4.0 PILING**

**4.1 GENERAL**

The Contractor shall be responsible for the quality as well as the number of Pile cast per day. Work should be done as per specification as well targets fixed. The Contractor's site representative shall give full time attention to the piling work in progress.

**4.2 PROGRAMME**

The Contractor shall inform the Engineer-in-charge each day of programme of piling for the following day and shall give adequate notice of his intention to work out side normal hours and week ends.

**4.3 SETTING OUT**

Setting out shall be carried out from the main grid lines of the proposed structure immediately before installation of the Piles, the Piles position shall be marked with suitable identifiable pins or markets. All layouts shall be checked with theodolite from original grid lines only and not from the Co – Ordinates of nearby Piles.

**4.4 RECORDING OF DAY TO DAY WORK**

Each pile being cast shall be recorded in a format as is given in respective specifications. There should be four copies of each record in different colours for easy differentiation. Two are to be submitted to engineer in charge. Out of the remaining, one to be submitted along with RA Bills and should be for the Contractor's records.

(The original shall be attached along with the RA Bill 2<sup>nd</sup> and 3<sup>rd</sup> copies to the Engineer – in – charge and the 4<sup>th</sup> one for the Contractor. The format shall be submitted to the Engineer- in- charge immediately after completion of concreting of the particular Pile. Any unexpected boring conditions reported in accordance with the particular obligation as specified in the format shall briefly be noted in the records.



**STANDARD TECHNICAL  
SPECIFICATION FOR PILING PART II  
- I GENERAL  
SPECIFICATIONS**

PEDC/STD.SPEC/4  
0(B)REV 00

Page 4 of 4

HYDERABAD

**4.5 FINISHING OF PILE HEAD**

Following excavation subsequently for pile cap construction the contractor shall carefully remove excess concrete above specified cut off level without damaging the remainder of the Pile including the Projecting reinforcement. Any cracked or defective concrete occurring below specified cut off level shall be cut away and made good with new concrete properly bonded to the old, at contractor's cost.

**4.6 VERTICALITY**

The maximum permitted deviation of the finished Pile from the vertical shall be as given in respective standard specifications.

**4.7 FORCIBLE CORRECTION**

Forcible corrections to concrete Piles shall not be made.

**4.8 NOISE DISTURBANCE**

The contractor shall carry out the work in such a manner and at such times as to minimum noise and disturbance.

**4.9 DAMAGE TO ADJACENT STRUCTURES**

If during the execution of the work damage is, or is likely to be, caused to mains services or adjacent structures the contractor shall submit to the Engineer – in – charge his proposal for repair and avoidance of such damage.

**4.10 DAMAGES TO PILES**

The contractor shall ensure that damage does not occur to completed Piles.



HYDERABAD

**STANDARD TECHNICAL  
SPECIFICATION FOR PILING PART  
III-SPECIFIC REQUIREMENTS**

PEDC/STD.SPEC/4  
0(C)REV 00

Page 1 of 6

**PILING PART III-SPECIFIC  
REQUIREMENTS**

REV. NO.	PRAPARED	APPROVED	DATE

**COPYRIGHT AND CONFIDENTIAL**

The information on this document is the property of BHARAT HEVY ELECTRICAL LTD.It must not be used directly or indirectly in any way detrimental to the interest of the Company.



HYDERABAD

**STANDARD TECHNICAL  
SPECIFICATION FOR PILING PART  
III-SPECIFIC REQUIREMENTS**

PEDC/STD.SPEC/4  
0(C)REV 00

Page 2 of 6

**PART III – SPECIFIC REQUIREMENTS**

**INDEX**

- 1.0 GENERAL REQUIREMENTS
- 2.0 PILE TYPE
- 3.0 SAFE LOAD CARRYING CAPACITY
- 4.0 MATERIALS
- 5.0 INSTALLATION
- 6.0 CONSTRUCTION
- 7.0 DEFECTIVE PILES
- 8.0 PILE TESTING
- 9.0 CRITERIA FOR ASSESSMENT OF SAFE LOADS
- 10.0 MEASUREMENT



**STANDARD TECHNICAL  
SPECIFICATION FOR PILING PART  
III-SPECIFIC REQUIREMENTS**

PEDC/STD.SPEC/4  
0(C)REV 00

Page 3 of 6

HYDERABAD

**1.0 GENERAL REQUIREMENTS**

All work shall be carried out in accordance with specifications enclosed herewith and the Contractor shall ensure minimum requirements as laid down hereunder.

**2.0 PILE TYPE**

The piles shall be 450mm diameter driven cast-in-situ RCC piles, up to 15m long and 10m long below cut-off level.

**3.0 SAFE LOAD CARRYING CAPACITY:**

The piles are designed for the following minimum safe load capacities.

- safe vertical load capacity = 70 T & 40T
- safe lateral load carrying capacity = 5T & 4T
- pull out capacity = 20T & 12T

**4.0 MATERIALS:**

4.1 Materials shall conform to BHEL specification no PEDC/STD/001 enclosed and forming a part of this bid document.

**4.2 Concrete:**

The concrete shall be of M-30 grade with minimum strength of 30N/mm<sup>2</sup> at 28 days. The other concrete specification shall be as per relevant clauses of standard specification for construction & installation of bored cast-in-situ piles BHEL specification No PEDC/STD/003.

**4.3 Cement:**

OPC / PPC-calcined based / PPC-Fly ash based / SRC shall be used. However, the cement content shall not be less than 400kg/m<sup>3</sup> maximum water/cement ratio of 0.45. the allowable slump shall be as per IS:2911 part1/sec1. The engineer-in-charge may also allow marginal adjustment of water/cement ratio to obtain concrete of good workability.

**4.4 Reinforcement:**

**4.4.1 Reinforcement**

The reinforcement requirement is as follows:

- a) Longitudinal reinforcement as per drawing to be submitted later.
- b) Links as per drawing to be submitted later.
- c) Clear cover shall be 50mm.



**STANDARD TECHNICAL  
SPECIFICATION FOR PILING PART  
III-SPECIFIC REQUIREMENTS**

PEDC/STD.SPEC/4  
0(C)REV 00

Page 4 of 6

HYDERABAD

**5.0 INSTALLATION:**

- 5.1 Installation of piles shall be carried out in accordance with pile layout drawings which shall be available to the contractor at the time of execution of work.
- 5.2 Cutoff level of the piles shall correspond to those given in the working drawings. For broad guidance, however, this may be assumed as 1.50 m below the NGL.
- 5.3 In case the reinforcement cage is made up of more than one segment, the same shall be assembled by welding only before lowering as per IS: 456 by providing necessary laps.
- 5.4 The vertical reinforcement shall project 55times its diameter above he cutoff level.

**6.0 CONSTRUCTION:**

- 6.1 Driven cast-in-situ piles
  - 6.1.1 The construction of piles shall be in accordance with the provision of bhel standard specification no PEDC/STD.SPEC/003.
  - 6.1.2 To ensure dense and sound concrete up to cutoff level concreting shall be as per IS :2911 part1/sec1 above the cut off level. However, no extra payment shall be made for this and quoted rate shall be inclusive of this.

**7.0 DEFECTIVE PILES:**

Defective piles shall be removed or left in place and replace by additional piled as directed by the engineer-in-charge at no additional cost.

**8.0 PILE TESTING:**

**8.1 Type of loading test**

**8.1.1 Initial loading test**

a) prior to commencement of the job piling, initial vertical and lateral tests shall be carried out on separate test piles cast for the purpose. The number of tests in each category shall be as given n schedule of quantities.

b) the contractor shall be allowed to proceed with the job piping only after successful completion of the various initial piles load tests to the satisfaction of the engineer-in-charge.

**8.1.2 Routine load tests**

The number of tests in each category shall be as given in schedule of quantities. The piles for the various tests shall be randomly selected by engineer-in-charge.

**8.2 Pile load test**

- 8.2.1 For various tests, the test set up shall be as “specification for testing of concrete piles (BHEL Standard Specification No PEDC/STD/005).



**STANDARD TECHNICAL  
SPECIFICATION FOR PILING PART  
III-SPECIFIC REQUIREMENTS**

PEDC/STD.SPEC/4  
0(C)REV 00

Page 5 of 6

HYDERABAD

8.2.2 All testing shall be done by the cyclic/direct loading test in minimums eight stages as per the relevant clause of “specification for testing of concrete piles” BHEL Standard PEDC/STD/005.

8.2.3 Each stage of loading for various tests should be maintained till the rate of movement of piles is less than 0.02mm/hr. however, this rate is not permitted to be extrapolated for 24hrs. And settlements shall be observed every hr. during this period.

8.2.4 Maximum test loads for various tests shall be as follows:

- a) Initial vertical pile load tests- twice the pile vertical load capacity
- b) Initial lateral pile load tests- twice the pile lateral load capacity.
- c) Initial pull out test - twice the pile pullout load capacity
- d) Routine vertical load test- one and half times pile vertical load capacity.
- e) Routine pullout load test – one and half times pile pullout load capacity

**9.0 CRITERIA FOR ASSESSMENT OF SAFE LOADS:**

**9.1 Safe vertical load**

It shall be the latest of the following:

-2/3 of final load at which the total settlement attains a value of 12mm.

-50% of the total at which load at which the total settlement equate 10% of the pile diameter.

The criteria for the safe load form routine load test shall also be the same.

**9.2 Safe lateral load**

Safe lateral load shall be the latest of the following:

-50% of the final load at which the pile deflection attains a values of 12mm

-Final load at which the total pile deflection corresponds to 5mm.

The criteria for the safe load form routine load test shall also be the same.

**9.3 Safe up lift load**

Safe up lift load on pile shall be the latest of the following:

a) Two-third of the load at which the total displacement attains a value of 12mm.

b) Half of the load at which the total displacement curve shows a clear break.

(downward trend)

A full record of pile load tests results shall be submitted to the engineer-in-charge immediately on completion of each test. The record shall also include the plots of load-settlement and time-settlement (for various stage of loads) characteristics of pile and also the interpretation of the pile load test curve as per criteria for safe loads as mentioned in clause 9.0 of “Specification Requirements”. Further it should also include driving record of tested piles. Any special observations shall be duly explained by the contractor.

**10.0 RATE:**

1. Rate to be quoted for piles shall be inclusive of all equipments, lab our and



HYDERABAD

**STANDARD TECHNICAL  
SPECIFICATION FOR PILING PART  
III-SPECIFIC REQUIREMENTS**

PEDC/STD.SPEC/4  
0(C)REV 00

Page 6 of 6

materials(excluding reinforcement) including boring, betonies slurry, concrete , chipping of excess concrete over cut off length, disposal of surplus earth , used slurry and debris beyond 2 KM distance, shifting of plant and equipment from pile to another etc, complete.

2. Rate for providing reinforcement to be quoted separately.

**11.0 MEASURMENT OF PILES**

1. The piles shall be measured and paid for the actual pile length from pile tip to cut-off level, given in the working drawings or as indicated by the engineer-in-charge. No extra payment shall be made for empty up to cut-off-level of 1.50mm below N.G.L or for concrete cast above cut-off-level (ref.clause 6.1.6)
2. If actual cut-off-length as per construction drawing is more than 1.50mm form N.G.L, payment for boring beyond 1.50m will be made.
3. Reinforcement will be measured as per actuals and paid for by weight as a separate item



HYDERABAD

**STANDARD TECHNICAL  
SPECIFICATION FOR PILING PART-IV  
– MATERIAL FOR REINFORCED  
CONCRETE PILES**

PEDC/STD.SPEC/4  
0(D) -- REV 00

Page 1 of 8

**PILING PART-IV – MATERIAL FOR REINFORCED  
CONCRETE PILES**

REV. NO.	PRAPARED	APPROVED	DATE

**COPYRIGHT AND CONFIDENTIAL**

The information on this document is the property of BHARAT HEVY ELECTRICAL LTD.It must not be used directly or indirectly in any way detrimental to the interest of the Company.



HYDERABAD

**STANDARD TECHNICAL  
SPECIFICATION FOR PILING PART-IV  
– MATERIAL FOR REINFORCED  
CONCRETE PILES**

PEDC/STD.SPEC/4  
0(D) -- REV 00

Page 2 of 8

**SPECIFICATION OF MATERIALS FOR REINFORCEMENT CONCRETE  
PILES**

**CONTENTS :**

1. GENERAL
2. MATERIALS FOR CONCRETE
3. ADMIXTURES
4. REINFORCEMENT



HYDERABAD

**STANDARD TECHNICAL  
SPECIFICATION FOR PILING PART-IV  
– MATERIAL FOR REINFORCED  
CONCRETE PILES**

PEDC/STD.SPEC/4  
0(D) -- REV 00

Page 3 of 8

**GENERAL**

**1.1 SCOPE :**

- 1.1.1 This specification establishes the material specification of reinforced Cement Concrete to be used in Pile foundations. Any special requirements as shown or noted on the drawings shall govern over the provisions of these specifications.
- 1.1.2 For specific work requirements concerning design and construction or otherwise modifying or supplementing the provision of this specification, refer to the specific requirements. In case of conflict between requirements. In case of conflict between specific requirements and provision of this specifications, former shall govern.

**1.2 DEFINITIONS**

- 2.1 Reference to Indian Standard Codes shall always mean reference to the latest issue of the relevant standards including all its amendments upto date.

**1.3 CODES :**

All design and construction shall be performed in accordance with the Indian Standard Code of Practice for plain and Reinforced Concrete IS : 456.

**2 MATERIALS FOR CONCRETE :**

**2.1 GENERAL :**

All materials which may be used in the Plain or Reinforced Cement Concrete work shall be of Standard quality manufactured by renowned concerns conforming to IS or equivalent and shall have IS certification mark as far as possible unless otherwise approved by the Engineer-in-charge. The contractor shall get all materials approved by Engineer-in-charge prior to its procurement and before actual use. The Engineer-in-charge shall have the right to determine whether all or any of the materials offered or delivered for use in the works are acceptable. Any material brought to site and conforming to specification and instruction of Engineer-in-charge shall be rejected and the contractor shall remove the same immediately from site at his own expenses.

**2.2 CEMENT :**

- 2.2.1 The cement used shall be ordinary Portland Cement conforming to IS : 8112 or Blast furnace slag cement conforming to IS : 455 or Portland pozzolona cement conforming to IS : 1489 or as specified and/or directed by the Engineer-in-charge.



HYDERABAD

**STANDARD TECHNICAL  
SPECIFICATION FOR PILING PART-IV  
– MATERIAL FOR REINFORCED  
CONCRETE PILES**

PEDC/STD.SPEC/4  
0(D) -- REV 00

Page 4 of 8

**2.2.2 TESTS AFTER DELIVERY :**

Each consignment of cement may, after delivery on the site and of the discretion of the Engineer-in-charge, be subjected to any or all of tests and analysis required by the relevant Indian Standard Specifications Facilities for testing shall be provided by contractor of his own cost.

**2.2.3 STORAGE ON THE SITE :**

The Cement shall be stored in a suitable weather-light building and in such a manner as to permit easy access for proper inspection to prevent deterioration. Cement of different types and brands shall be kept in separate storage.

All accepted cement stored on the site shall be arranged in batches, and used in the same order as received from the manufacturer. The contractor shall maintain a cement register in which all entries shall be completed day to day showing the quantities received, date of receipt, source of despatch, type of cement, etc. and also the daily cement consumption on site. The register shall be accessible to the Engineer-in-charge for his verification.

**2.2.4 REJECTION OF CEMENT :**

The Engineer-in-charge may reject any cement as a result of any tests thereof, notwithstanding the manufacturer's certificate. He may also reject cement which has deteriorated owing to inadequate protection from moisture or due to intrusion of foreign matter or other causes. Any cement which is considered defective by the engineer-in-charge shall not be used, and shall be promptly removed from the site of the work by the contractor at his own expense.

**2.3 AGGREGATES FOR CONCRETE :**

**2.3.1 GENERAL :**

Coarse and Fine Aggregates for concrete shall conform in all respects to IS : 383, 'Specification for Coarse and Fine Aggregates from Natural Sources for Concrete'. Aggregate, shall be obtained from a source known to produce those satisfactory for concrete. Aggregates shall consist of naturally occurring sand and gravel or stone, crushed or uncrushed, or a combination thereof. They shall be chemically inert, hard, strong, dense, durable, clean and free from veins, adherent coatings and shall be of limited porosity.

Flaky and elongated pieces shall not be used. Wherever required by the Engineer-in-charge the aggregates shall be washed by the contractor before use in the work.



HYDERABAD

**STANDARD TECHNICAL  
SPECIFICATION FOR PILING PART-IV  
– MATERIAL FOR REINFORCED  
CONCRETE PILES**

PEDC/STD.SPEC/4  
0(D) -- REV 00

Page 5 of 8

The source of aggregate shall be approved by the Engineer-in-charge and shall not be changed during the course of the job without this approval. Rejected aggregates shall be removed from the work site by the contractor of his own expense.

**2.3.2 DELETERIOUS MATERIALS :**

Aggregate shall not contain any harmful materials, such as iron pyrites, coal, mica, shale or similar laminated materials, clay, alkali, soft fragments, sea shells, organic impurities etc. in such quantities as to affect the strength or durability of the concrete in addition to the above, for reinforced concrete, any materials which might cause corrosion of the reinforcement, and aggregates which are chemically reactive with alkali of cement shall not be used.

The maximum quantities of deleterious materials in the aggregates, as determined in accordance with IS.2386 (part-II). Methods of Test for Aggregates for concrete, shall not exceed the limits given in Table –I of IS 383.

The sum of the percentages of all deleterious materials shall not exceed five. Deleterious materials also include materials passing 75 micron IS sieve.

**2.3.3 COARSE AGGREGATES**

Coarse aggregate is aggregate most of which is retained on 4.75mm sieve.

These may be obtained from crushed or uncrushed gravel or stone as per Cl. 2.3.1 and may be supplied as single sized or graded aggregates given in table II of IS :383.

The Engineer-in-charge may allow all-in-Aggregate to be used provided they satisfy, the requirements of clause 4.4 and Table – IV of IS :383.

**2.3.4 FINE AGGREGATES**

Fine aggregate is aggregate most of which passes 4.75mm IS : Sieve but not more than 10% pass through 150 microns IS : Sieve. These shall comply with the requirements of grading Zone II of IS :383. Fine aggregate conforming to grading Zone shall not be normally used in reinforced concrete unless tests have been made by the contractor to ascertain the suitability of the proposed mix proportions and approved by the Engineer-in-charge.

Fine aggregates shall consist of natural sand resulting from natural disintegration of rock which has been deposited by streams or glacial agencies, or crushed stone sand or crushed gravel sand.

**2.3.5 SAMPLING AND TESTING**

In case of doubt the Engineer-in-charge may require the contractor to carry out tests, at the contractor's expense in accordance with



HYDERABAD

**STANDARD TECHNICAL  
SPECIFICATION FOR PILING PART-IV  
– MATERIAL FOR REINFORCED  
CONCRETE PILES**

PEDC/STD.SPEC/4  
0(D) -- REV 00

Page 6 of 8

IS :516- Method of Tests for Strengths of Concrete and

IS :2386-Methods of tests Aggregates for Concrete.

**2.3.6 STORAGE OF AGGREGATES**

The contractor shall at all times maintain at the site of work such quantities of aggregate as considered by the Engineer-in-charge to be sufficient to ensure continuity of work.

Each type and grade of aggregate shall be stored separately on hard firm ground having sufficient slope to provide adequate drainage to rain water.

Any aggregate delivered to site in a wet condition or becoming wet at site due to rain shall be kept in storage for at least 24hrs. To obtain adequate drainage, before it is used for concreting, or the water content of mix must be suitably adjusted as directed by Engineer-in-charge.

**2.4 WATER**

Water used for concrete shall be clear and free from injurious amounts of Oil, Alkali, Organic matters or other harmful substances in amounts that may impair the strength or durability of the structure. Potable water shall generally be considered satisfactory for mixing and curing concrete.

The Engineer-in-charge may require the contractor to prove at latter's expense, that the concrete mixed with water proposed to be used should not have a compressive strength, lower than 90% of the strength of concrete mixed with distilled water.

The Engineer-in-charge may require the contractor to get the water tested from an approved laboratory at his own expense and in case the water contains any sugar or an excess acid, alkali, any injurious salts etc. the Engineer-in-charge may refuse to permit its use.

**3. ADMIXTURES.**

3.1 Admixtures such as CICO grade I or puddle or equivalent may be used in concrete only with the approval of Engineer-in-charge.

**4. REINFORCEMENT**

4.1 Mild steel Bars

4.1.1 The reinforcement shall normally be mild steel in the form of round bars, conforming to IS : 432 Grade I unless specified otherwise.



**STANDARD TECHNICAL  
SPECIFICATION FOR PILING PART-IV  
– MATERIAL FOR REINFORCED  
CONCRETE PILES**

PEDC/STD.SPEC/4  
0(D) -- REV 00

Page 7 of 8

HYDERABAD

4.2 Hard Drawn Steel Wire fabric.

4.2.1 When specified on the drawings, hard drawn steel wire fabric shall be used conforming to IS : 1566 - It shall be of an approved type and of weights and dimensions shown on the drawing.

4.3 High yield Deformed Steel Reinforcement conforming to IS :1786

4.3.1 Cold twisted high yeild deformed steel bars, shall conform to IS :1139.

4.4 Other Bars & Sections

4.4.1 Any other type of reinforcement bars specified on the drawings shall conform to its respective Indian standard Specification. Medium Tensile Steel Bars when specified on the

4.5 **WELDING**

4.5.1 Field welding of reinforcing bars not be permitted without the written consent of the Engineer-in-charge. Where welding is permitted it must be at staggered locations. Tests shall be made to prove that the joints are of the full strength of bars connected. Welding of reinforcement shall be done in accordance with the recommendation of IS : 2751.

4.6 **STORAGE**

4.6.1 The Steel reinforcement shall be stored in such a way as to avoid distoration and to prevent distoration and corrosion.

4.7 **OTHER SPECIFICATION**

4.7.1 General construction details and workmanship relative to reinforcement including bar bends, lap splices and installation shall be in accordance with IS : 2502 – Code of practice for Bonding and Fixing of bars for concrete reinforcement, as well as the detaining of reinforcement given in IS : 456.

4.7.2 Hot bending of bars shall not be allowed.

4.7.3 The number sizes, shape and position of all the reinforcement shall, unless otherwise directed or authorised by the Engineer-in-Charge, be strictly in accordance with the drawings. The reinforcement shall be adequately secured and held in position by metal chairs and spacers. Ties at inter-sections shall be made with 16 SWG soft block annealed binding wire.

4.7.4 The contractor must obtain the approval of the Engineer-in-charge for the reinforcement placed, before any concrete is placed in the forms. The reinforcement at this time shall be free from loose rust or scale of other coatings that will destroy or reduce bond.



HYDERABAD

**STANDARD TECHNICAL  
SPECIFICATION FOR PILING PART-IV  
– MATERIAL FOR REINFORCED  
CONCRETE PILES**

PEDC/STD.SPEC/4  
0(D) -- REV 00

Page 8 of 8

- 4.7.5 Concrete spacer blocks of the same strength as parent concrete, shall be used to ensure correct cover to the reinforcement. This clear cover shall be as shown on the drawings or as per instructions of the Engineer – in-charge.
- 4.7.6 All the reinforcing bars shall be so tied as to form a rigid cage to prevent displacement before or during concreting.



HYDERABAD

**STANDARD TECHNICAL  
SPECIFICATION FOR PILING PART-V  
TESTING OF CONCRETE PILES**

PEDC/STD.SPEC/4  
0(E)REV 00

Page 1 of 11

**PILING PART-V  
TESTING OF CONCRETE PILES**

REV. NO.	PRAPARED	APPROVED	DATE

**COPYRIGHT AND CONFIDENTIAL**

The information on this document is the property of BHARAT HEVY ELECTRICAL LTD.It must not be used directly or indirectly in any way detrimental to the interest of the Company.



HYDERABAD

**STANDARD TECHNICAL  
SPECIFICATION FOR PILING PART-V  
TESTING OF CONCRETE PILES**

PEDC/STD.SPEC/4  
0(E)REV 00

Page 2 of 11

**CONTENTS**

1. GENERAL
2. VERTICAL LOADING TESTS
3. LATERAL LOADING TEST
4. PULL OUT CAPACITY OF PILES
5. COMBINED VERTICAL AND LATERAL LOADING
6. SPECIAL TYPE OF LOADING

APPENDIX 1 – PILE LOADING TEST RECORD



**STANDARD TECHNICAL  
SPECIFICATION FOR PILING PART-V  
TESTING OF CONCRETE PILES**

PEDC/STD.SPEC/4  
0(E)REV 00

Page 3 of 11

HYDERABAD

**1. GENERAL**

**1.1 Scope**

1.1.1 This specification covers the requirements and methods of testing of a single pile for evaluating its safe capacity in :

- a) Vertical Loading (compression )
- b) Lateral loading
- c) Pull out.
- d) Combined vertical and lateral loading.
- e) Special type of loading such as vibratory loadings.

1.1.2 These specifications shall be applicable for all types of piles in general excepting sheet piles.

1.1.3 For specific work requirements or otherwise modifying or supplementing the provisions of this specification, refer to specific requirements. In case of conflict between requirements set forth in the specific requirements and the provisions of this specification, the specific requirements and the provisions of this specification, the specific requirements shall govern.

**1.2 Definitions**

1.2.1 Reference to Indian Standard codes shall always mean reference to the latest issue of the relevant standards, including all the amendments up to date.

**1.3 Codes**

1.3.1 All testing shall be performed in accordance with the following codes and the provisions of these specifications:

IS: 2911 – (part-IV) – Codes of practice for design and Construction of Pile Foundations – Load test on piles.

**1.4 Requirements**

1.4.1 The load test shall be required to provide data regarding the load – deformation characteristics of the pile up to failure or otherwise specified and the safe design capacity.



**STANDARD TECHNICAL  
SPECIFICATION FOR PILING PART-V  
TESTING OF CONCRETE PILES**

PEDC/STD.SPEC/4  
0(E)REV 00

Page 4 of 11

HYDERABAD

1.4.2 Full details of the equipment proposed to be used and the test set up shall be submitted to the Engineer-in-Charge with detailed sketches for approval. Approval of the Engineer-in-Charge shall be also be obtained after the test set up is complete, prior to commencement of loading.

1.4.3 All measuring devices shall be tested satisfactory performance and accuracy at an approved institution and certificate to that effect obtained and submitted to the Engineer –in-charge, prior to use.

1.4.4 The test pile shall be constructed using the same equipment and technique as for the job piles.

1.4.5 A minimum time period of one week shall be allowed between the time of installation and testing in case of a precast pile and less than four weeks from the time of vesting in case of a cast-in situ pile.

1.4.6 Recodes

A full record giving all details of the test in the Proforma in appendix-1 shall be submitted in TRIPLICATE to the Engineer-in-Charge immediately on COMPLETION of each test. The record shall also include the plot of load- time settlement characteristics of the piles.

**2 VERTICAL LOADING TEST:**

2.1 Equipment and test Set-up

**2.1.1 Test pile**

2.1.1.1 The test pile shall be decided by the Engineer-in-Charge. It may be one of the working piles or separate test pile.

2.1.1.2 The head of the test pile shall be brought to the proper level and provided with a pile cap with a moral and plane surface and with adequate space for proper seating of a jack and dial gauges.

2.1.1.3 Test pile surface shall be prepared for testing purposes on the expiry of one week after casting the pile.

**2.1.2 Loading Systems**

2.1.2.1 Loading shall be applied by the reaction method consisting of an hydraulic jack reacting centrally against a loaded platform. Supports of the platforms shall be adequately designed. Special anchor piles or any other suitable type of anchorage system may also be used. However, use of the uplift supply of neigh boring piles for providing the reaction shall normally not be permitted.



**STANDARD TECHNICAL  
SPECIFICATION FOR PILING PART-V  
TESTING OF CONCRETE PILES**

PEDC/STD.SPEC/4  
0(E)REV 00

Page 5 of 11

HYDERABAD

2.1.2.2 The loading system shall be adequate to ensure that the test can be carried up to the specified limit. The reaction to be made available for the test shall be at least 25% greater than the maximum jacking force required.

**2.1.3 Measuring System**

**2.1.3.1 Loading on piles**

The load applied on the pile shall be recorded on a calibrated pressure gauge mounted on the jack.

**2.1.3.2 Settlement of pile**

- a) Settlement of pile shall be recorded by dial gauges suspended from datum bars.
- b) The datum bars shall have rigid supports preferably of concrete pillars or steel section, embedded well into the ground. The supports shall be locked more than three times the piles diameter, subject to a minimum of 1.5 M, clear away from the pile face and also sufficiently away from the supports of the loaded plat from to avoid any disturbance on these accounts. Movements near the supports of the datum bar shall be avoided while the test is in progress.

**2.2 Method of conducting Test**

The test shall be carried out by the direct method of loading in successive increments or by the cyclic loading method as specified and as directed by the engineer-in-charge.

**2.2.1 Direct Method of Loading in Successive Increments**

The test shall be carried out as per the procedure outlined.

- a) The load shall be applied to the pile top in increments of about one fifth the rated capacity of the pile or as specified. Settlement readings shall be taken before and after the application of cash new load increment and at 2, 4, 8,15,30,60 minutes and at every two hours until application of the next load increment.
- b) Each stage of loading shall be maintained till the rate of movement of the pile top is not more than, 0.1 mm in first 30minutes, 0.2 mm per hours or until two labours have elapsed, whichever is later.
- c) (I) Yield of soil-pile system occurs causing progressive settlement of the pile exceeding a value of one tenth of the pile diameter.



**STANDARD TECHNICAL  
SPECIFICATION FOR PILING PART-V  
TESTING OF CONCRETE PILES**

PEDC/STD.SPEC/4  
0(E)REV 00

Page 6 of 11

HYDERABAD

(II) The loading on the pile top equals twice the rated capacity or as specified in the case of a separate test pile and 1.5 times the rated capacity of the pile in case of a working pile.

- d) Where yielding of the soil does not occur, the full test load shall be maintained on the pile head for 24 hours or more if necessary and settlement reading shall be taken at 6hours interval during the period.
- e) Unloading shall be carried out in the same steps as loading. A minimum period of ½ hour shall be allowed to elapse between two successive stages of load decrement. The final rebound shall be recorded 6 hours after the entire test load has been removed.
- f) If so directed by the Engineer-in- charge, loading and unloading cycles shall be carried out for all load stages within the assumed working load.
- g) Assessment of Safe Load:  
  
The safe of the pile shall be the least of following values:
  - i) 2/3 of final load at which the total displacement attains a value of 12mm. Unless otherwise required, in given case on the basis of nature and type structure in which case, the safe load should be corresponding to the stated total displacement permissible.
  - ii) 50 percent of final load at which the total settlement equate the 10% of pile diameter in case of bored piles and 7.5 percent of bulb diameter in case of under – reamed piles.

**2.2.2 Cycle Loading Test**

The test shall be carried out as per the procedure outlined by IS: 2911 – (part – IV) and as described below:

- a. The load shall be supplied to the pile top in increments of about one fifth the estimated safe capacity of the pile or as specified. Settlement readings shall be taken before and the application of each new load increment and at 2, 4, 8,15,30,60 minutes and at every two hours until application of the next load increment.
- b. Alternate loading and unloading shall be carried out at each stage and the total and net settlements recorded as specified. If so directed by the Engineer-in-charge, more then one cycle of loading and unloading shall be carried out at any or all of the stages.



HYDERABAD

**STANDARD TECHNICAL  
SPECIFICATION FOR PILING PART-V  
TESTING OF CONCRETE PILES**

PEDC/STD.SPEC/4  
0(E)REV 00

Page 7 of 11

c. Each stage of loading or unloading shall be maintained till the rate of movement of the pile top is not more than 0.2 mm per hour provided that the minimum period is two hours for loading and one hour for unloading. The following load stages shall however be maintained for longer periods as given below:

- i) At 1.5 times assumed safe Capacity (for routine test only) - 24 hours.
- ii) At load of twice assumed safe capacity ( for initial test only ) - 24 hours

This loading shall be continued till one of the following occurs:

- i) Yield of the soil pile system occurs causing progressive settlement exceeding one tenth of the pile diameter.
- ii) The loading on the pile top equals twice the estimated safe load in case of a separate test pile and 1.5 times the rated capacity of the pile in case of working pile.

d) Assessment of Safe Load :

The safe capacity of the pile shall be the least of the following:

- i) Two thirds of the final load at which the total settlement attains a value of 6 mm.
- ii) Two thirds of the final load at which the total settlement attains a value of 6 mm.
- iii) Half of the final load at which the total settlement equals one tenth of the pile diameter.

### **3. LATERAL LOADING TEST:**

#### **3.1. Equipment and test set-up**

##### **3.1.1 Test Pile**

The test pile shall be decided by the Engineer-in-Charge. It may be one of the working piles or a separate test pile.

The test pile shall be cut off at the proper level and provided with a cap with vertical plane sides having an adequate area for proper seating of the jack and dial gauges.

##### **3.1.2 Loading System**



**STANDARD TECHNICAL  
SPECIFICATION FOR PILING PART-V  
TESTING OF CONCRETE PILES**

PEDC/STD.SPEC/4  
0(E)REV 00

Page 8 of 11

HYDERABAD

Loading shall be applied by an hydraulic jack of adequate capacity, abutting the pile horizontally and reacting against a suitable system. The reaction may be provided by the wall of the excavated-pit when the test is being conducted below ground level or by a neighbouring pile in which case thrust pieces shall be inserted on either end of the jack to make up the gap.

**3.1.3 Measuring System**

3.1.3.1 Lateral load applied on the pile shall be measured by a calibrated pressure gauge mounted on the jack, having a least count of 500 Kg.

3.1.3.2 Deflection of the pile head shall be measured by dial gauges, fixed to datum bars and having a least count of 0.01 mm. The datum bars shall be provided with rigid supports as described in Clause 2.1.3.2 (b) above.

**3.2 Method of Conducting Test :**

The test shall be carried out in accordance with the provisions of IS: 2911– (part-I) and as detailed below:

3.2.1 Loading shall be applied in increments of 500 kgs. or as specified.

3.2.2 Each stage shall be maintained for a period till the rate of movement of the pile head is not more than 0.1 mm / 30 min. or 1 hr. whichever is greater.

3.2.3 Loading shall be continued till one of the following occurs:

- a) Deflection of the pile head exceeds 12 mm.
- b) The applied load on the pile is twice the assumed lateral load capacity of the pile in case of a separate test pile and  $1 \frac{1}{3}$  Times the rates capacity in the cast of a working pile.

**3.2.4 Assessments of Safe Load :**

The safe load shall be the smaller of the following:

- i) Half the final load for which the total deflection is 12 mm.
- ii) Loading corresponding to 5 mm total defection.

NOTE: The deflection is at the cut off level of the pile.

**4. PULL OUT CAPACITY OF PILES**

**4.1 Equipment and test Set up**

**4.1.1 Test pile**



**STANDARD TECHNICAL  
SPECIFICATION FOR PILING PART-V  
TESTING OF CONCRETE PILES**

PEDC/STD.SPEC/4  
0(E)REV 00

Page 9 of 11

HYDERABAD

The test pile shall be decided by the Engineer-in-Charge. The test shall be conducted on a separate pile installed separate pile installed specifically for this purpose.

4.1.1.2 The test pile shall be built upto the proper length and the proper length and the head provided with suitable arrangements for anchoring the load applying system.

**4.1.2 Loading System**

4.1.2.1 Load shall be applied using an approved reaction system uplift force on the pile may be applied directly to the test pile or through a lever system. The reaction may be provided by neighbouring piles or blocks may be constructed for the purposes. A hydraulic jack shall be used for load application.

**4.1.3 Measuring System**

4.1.3.1 Load applied by jack shall be measured by a calibrated pressure gauge with a least count of 1000 kgs.

4.1.3.2 Movement of the pile shall be measured by dial gauges, fixed to datum bar and having a least count of 0.01 mm. A minimum of two dial gauges, placed diametrically opposite shall be used. Datum bars shall be provided with rigid supports as described in 2.1.3.2 (b) above.

**4.2 Method of Conducting Test**

The test shall be conducted as outlined below:

4.2.1 Loading shall be applied to the pile top increments of one fifth the rated capacity of pile.

4.2.2 Each stage shall be maintained for a period till the rate of movement of the pile head is not more then 0.1 mm / 30 min. or one hour, whichever is greater.

4.2.3 Loading shall be continued till one of the following occurs:

- a) Yield of soil pile system occurs causing progressive movement of the pile exceeding 12 mm.
- b) The loading on the pile top equals twice the estimated safe load or as specified.

**4.3 Assessment of Safe Load**

The safe capacity of the pile shall be the smaller of the following:



**STANDARD TECHNICAL SPECIFICATION FOR PILING PART-V TESTING OF CONCRETE PILES**

PEDC/STD.SPEC/40(E)REV 00

Page 10 of 11

HYDERABAD

- a) Two-thirds of the load at which the total displacement is 12 mm or the load corresponding to a specified permissible up lift, and
- b) Half of the load at which the load-displacement curve show as a clear break (downward trend).

**5. COMBINED VERTICAL AND LATERAL LOADING :**

**5.1 Equipment and Test Set-up**

5.1.1 The equipment and test set up shall be same described in Clause 3.. In addition a platform shall be constructed on the pile top, and loaded to 1.0 times the pile capacity in vertical loading.

The pile shall be first subjected to the full vertical load. The lateral load shall commence after all settlements due to the vertical load have ceased and while the full vertical load is in position.

5.1.2 The loading system, measuring system and recording of results shall be the same as described in Clause – 3.

**5.2 Method of Conducting Test and Assessment of Safe Load**

This shall be in accordance with the provision of Clause 3.2 above.

**6. SPECIAL TYPE OF LOADING**

This shall include evaluating the pile response to vibratory loads, both horizontal and vertical in nature. The test set up and method of conducting the test shall be covered under specific requirements.

APPENDIX

FILE NO.....DATE OF ..... WT. OF HAMMER.....

TYPE.....DRIVING .....AVR. DROP OF HAMMER.....

DIAMETER (CM).....CASTING.....TOTAL NO. OF BOWS.....

LENGTH BELOW COMMENCEMENT OF TEST... SUM OF TEMPORARY

G.L.(M)..... COMPRESSION IN CMS.....

LOCATION ..... COMPLETION OF TEST..... GROUND LEVEL .....

TYPE OF TEST: DIRECT/CYCLE LOADING

SETTLEMENT

AVRSETTLEMENT



**STANDARD TECHNICAL  
SPECIFICATION FOR PILING PART-V  
TESTING OF CONCRETE PILES**

PEDC/STD.SPEC/4  
0(E)REV 00

Page 11 of 11

**HYDERABAD**

DATE	TIME	TOTAL TIME	LOAD ON	LOAD OFF	TOTAL LOAD	(DEFLECTION) GAUGE	(DEFLECTION)	SOUND REMARKS	
								I	II
								TOTAL	NETT

HR.MINS TONNES TONNES MM MM MM MM M



**STANDARD TECHNICAL  
SPECIFICATION FOR PILING-PART VI**

PEDC/STD.SPEC/4  
0(H) REV 00

**CONSTRUCTION AND INSTALLATION  
OF DRIVEN CAST-IN-SITU PILES**

Page 1 of 6

HYDERABAD

**PILING-PART VI**

**CONSTRUCTION AND INSTALLATION OF  
DRIVEN CAST-IN-SITU PILES**

REV. NO.	PRAPARED	APPROVED	DATE

**COPYRIGHT AND CONFIDENTIAL**

The information on this document is the property of BHARAT HEVY ELECTRICAL LTD.It must not be used directly or indirectly in any way detrimental to the interest of the Company.



**STANDARD TECHNICAL  
SPECIFICATION FOR PILING-PART VI**

PEDC/STD.SPEC/4  
0(H) REV 00

**CONSTRUCTION AND INSTALLATION  
OF DRIVEN CAST-IN-SITU PILES**

Page 2 of 6

**HYDERABAD**

**CONTENTS :**

**SECTION DESCRIPTION**

- 1.0 SCOPE
- 2.0 CODES
- 3.0 MATERIALS
- 4.0 DESIGN CONSIDERATIONS
- 5.0 EQUIPMENT AND ACCESSORIES
- 6.0 CONTROL OF PILE DRIVING



**STANDARD TECHNICAL  
SPECIFICATION FOR PILING-PART VI**

PEDC/STD.SPEC/4  
0(H) REV 00

**CONSTRUCTION AND INSTALLATION  
OF DRIVEN CAST-IN-SITU PILES**

Page 3 of 6

HYDERABAD

**1.0 SCOPE :**

- 1.1 This standard specification covers the construction and installation of driven cast-in-situ load bearing concrete piles.
- 1.2 For specific work requirements concerning construction or otherwise modifying or supplementing the provisions of this specifications, reference may be made to 'Specific Requirements' In the case of may conflict between the requirements set forth in specific Requirements and the provisions of this specification, the 'Specific Requirements' shall govern.

**2 CODES :**

- 2.1 IS : 2911 (PartI/SecI). Indian Standard code of practice for Design and Construction of pile foundations : Part I Concrete Piles, section 1 Driven Cast – In- Situ load bearing concrete piles, shall be referred to in conjunction with these specifications during the entire design, construction and installation work.
- 2.2 Reference to any code shall always mean reference to the latest revised edition of The code including all its amendements upto date, unless otherwise specified. In the event of any conflict between the requirements of this specification and those of the refered codes, the former shall govern.

**3 MATERIALS :**

- 3.1 All materials, viz, cement, steel, aggregates, water etc, which are to be used in the construction work, shall conform to BHEL, Standard Specification for Material for Reinforced concrete Piles, No PEDC /STD.SPEC /040-d.

**3.2 CONCRETE :**

- 3.2.1 Method of the manufacture of cement concrete shall in general, be in accordance with IS : 2911 (PartI/ Sec. I) and as per following clauses.
- 3.2.2 Consistence of concrete shall be suitable to the method of installation of piles.
- 3.2.3 The min. slump shall be 100mm when concrete in the pile is not compacted. It shall not exceed 175mm in any case.
- 3.2.4 The min. grade of concrete to be used for pilling shall be M-30. For the concrete not exposed to sulphate attack, the min. cement content shall be 400 kg/m<sup>3</sup>.
- 3.2.5 The average compressive stress under working load shall not exceed 25% of the specified works cube strenth at 28 days calculated on the total cross sectional area of the pile. Where the casing of the pile is a) Permanent, b) of adequate strenth



**STANDARD TECHNICAL  
SPECIFICATION FOR PILING-PART VI**

PEDC/STD.SPEC/4  
0(H) REV 00

**CONSTRUCTION AND INSTALLATION  
OF DRIVEN CAST-IN-SITU PILES**

Page 4 of 6

HYDERABAD

and c) of suitable shape, the allowable compressive stress may be increased.

**4 DESIGN CONSIDERATIONS :**

4.1 Pile shall be designed in such a way that the load from the structure or supports should be transmitted to the soil without causing any soil failure and without causing such settlement differential /total under permanent/transient loading which may result in structural damage and /or functional distress. The pile shaft have adequate structural capacity to withstand all loads and moments which are to be transmitted to the subsoil.

**4.2 REINFORCEMENT :**

4.2.1 The design of reinforcement cage and the min. reinforcement shall be in accordance with is : 2911 (Part I Sec. I)

4.2.2 The reinforcement shall be normally provided upto the full depth of pile the designed quantity of reinforcement may be curtailed at appropriate level as per design requirements in case of piles subject to compressive load only provided it could be ensured that there shall be no danger to green concrete due to driving of adjacent piles. The minimum area of longitudinal reinforcement within the pile shaft shall be 0.4% of the sectional area.

4.2.3 The min. clear cover to reinforcement shall be 50mm. The lateral of the reinforcement cage in spacing shall be chosen to impart adequate rigidity of the reinforcing cage during handling and installations. For aggressive soil conditions, the clear cover shall be suitably increased in case special cement is not used.

**5 EQUIPMENT AND ACCESSORIES :**

5.1 Equipment and accessories shall in general confirm to requirements but not limited to that, stated in the relevant clause of IS : 2911 (Part I/Sec I).

5.2 List of equipments and accessories to be used for a specific project shall be submitted along with the bids ; demonstrating that the piles would be installed to the design penetration. The equipment and accessories shall also be approved by Engineer-in-Charge at the time mobilisation.

5.3 Based on the site investigation data, contractor should also submit list of anticipated problems and remedial actions proposed by him to overcome these anticipated problems including requirement of mobilization and use of necessary equipments for the purpose.

**6. CONTROL OF PILE INSTALLATION**

6.1 CONTROL OF ALIGNMENT :



**STANDARD TECHNICAL  
SPECIFICATION FOR PILING-PART VI**

PEDC/STD.SPEC/4  
0(H) REV 00

**CONSTRUCTION AND INSTALLATION  
OF DRIVEN CAST-IN-SITU PILES**

Page 5 of 6

HYDERABAD

Pile shall be installed as accurately as possible either vertical or to the specified inclination. As a guide for vertical piles, a deviation of 1.5% and for raker a deviation of 4% shall be normally permitted. Piles shall not be out of position by more than 75 mm from the designed location at the working level of piling rig. In case of a single pile in a column, positional tolerance shall not exceed 50 mm. In case of piles deviating beyond these limits and to such an extent that the resulting eccentricity cannot be taken care of by a redesign of the pile cap or pile tiles, piles shall be replaced or supplemented by one or more additional piles.

6.2 WITHDRAWAL OF CASING :

6.2.1 It shall be ensured that volume of concrete poured in at least equal the volume of pile shaft being concreted and the rate of concreting should match with the rate of withdrawal of casings. It should be ensured that minimum 1 m height of concrete should always be maintained in the casing.

6.2.2 When withdrawing the casing, the head of concrete in the hole shall always be more than the head of ground water table outside the casing to prevent inflow of water inside.

6.3 ADJACENT STRUCTURES :

6.3.1 When Working near existing structures care shall be taken to avoid any damage to such structure. Fig 1 of IS : 2974 (Part I) may be followed as a guide.

6.3.2 In case of deep excavation adjacent to piles, proper shoring or other suitable arrangement shall be made to guard against the lateral movement of soil stratum or releasing the confining soil stress.

6.4 SEQUENCE OF PILING :

6.4.1 In a pile group, the sequence of installation of piles shall normally be from the centre to the periphery of the group or from one side to the other.

6.4.2 In case of compact soil specially, the consideration shall be given to the possibility of doing harm to a pile recently formed by driving the tube nearby before the concrete has sufficiently set.

6.4.3 Driving piles in loose sand tends to compact the sand which in turn increases the skin friction. Therefore, the order of installing such a pile in a group shall avoid creating a compacting block of ground into which further piles cannot be driven.



**STANDARD TECHNICAL  
SPECIFICATION FOR PILING-PART VI**

PEDC/STD.SPEC/4  
0(H) REV 00

**CONSTRUCTION AND INSTALLATION  
OF DRIVEN CAST-IN-SITU PILES**

Page 6 of 6

**HYDERABAD**

In case where stiff clay or compact sand layer have to be penetrated, similar precautions need to be taken. This may be overcome by driving the piles from the centre outwards or by beginning at a selected edge or working across a group. However, in case of soft soils, the driving may have to proceed from outside to inside so that the soils is restrained from flowing out during operations.

**6.5 JETTING**

Jetting of casings by means of water shall not normally be permitted. In every special circumstances however, it may be carried out only with the express permission of the Engineer-in-Charge without impairing the bearing capacity of piles already in place, the stability of soil, or the safety of any adjoining building.

6.6 The top of concrete in a pile shall be brought above the cut-off level to remove all laitance and weak concrete before capping and to ensure good concrete at the cut-off level. The reinforcing cage shall be left with adequate protruding length above the cut off level for embedment into the pile cap.

6.7.1 As a general guide line for cut-off level upto 1.5m below working level, the concrete shall be cast to a min. of 1000mm above cut off level or upto the ground. For each additional 0.3m increase in cut-off level below working level, an additional coverage of 50mm shall be allowed.

**6.8 DEFECTIVE PILE**

Defective pile shall be removed or left in place without affecting the performance of the adjacent piles or the cap as a whole. Additional piles shall be provided to replace them when required.

6.9.1 Any deviation from designed location alignment or load capacity of any pile shall be noted and adequate measures taken well before concreting of the pile cap and plinth beam.

6.9.2 During chipping of the pile cap, manual chipping may be permitted after three days of pile casting while pneumatic tool for chipping shall not be used before seven days after pile casting.

**6.10 RECORDING OF DATA**

Typical data sheets for recording piling data shall be as shown in IS : 2911 (Part I/Sec I).

**FORMAT FOR NO DEVIATION CERTIFICATE**  
**(To be submitted in the bidder's letter head)**

BHARAT HEAVY ELECTRICALS LIMITED,  
Power Sector - Eastern Region,  
Plot no 9/1, DJ Block, Sector – II, Salt Lake City,  
Kolkata – 700 091

Sub	No Deviation Certificate.	
Job	Civil, structural, architectural work including piling work of main plant, BOP etc; erection, testing, commissioning etc of 2x80 TPH utility boiler & aux, 2x80 TPH HRSG & aux, 2xFr5 GTG & aux, 1x13.5 MW STG & aux, 2 nos steel chimney for utility boiler, 2 nos steel chimney for HRSH, associated piping, associated electrical, associated C&I etc for 53 MW Combined Cycle Power Plant at BCPL, Lepetkata, Assam.	
Ref	1.0	Tender no PSER:SCT:LPT-A1114:10.
	2.0	BHEL's NIT, vide reference no PSER:SCT:LPT-A1114:2310, dated 23-07-10.
	3.0	BHEL's TCN-01, vide reference no PSER:SCT:LPT-A1114:TCN-01, dated 16-08-10.
	4.0	BHEL's TCN-02, vide reference no PSER:SCT:LPT-A1114:TCN-02, dated 30-08-10.
	5.0	BHEL's TCN-03, vide reference no PSER:SCT:LPT-A1114:TCN-03, dated 08-09-10.
	6.0	BHEL's TCN-04, vide reference no PSER:SCT:LPT-A1114:TCN-04, dated 20-09-10.
	7.0	BHEL's TCN-05, vide reference no PSER:SCT:LPT-A1114:TCN-05, dated 22-09-10.
	8.0	BHEL's TCN-06, vide reference no PSER:SCT:LPT-A1114:TCN-06, dated 23-09-10.
	9.0	BHEL's TCN-07, vide reference no PSER:SCT:LPT-A1114:TCN-07, dated 24-09-10.
	10.0	All other pertinent issues till date.

Dear Sirs,

With reference to above, this is to confirm that as per tender conditions, we have visited site before submission of our offer and noted the job content & site conditions etc. We also confirm that we have not changed/ modified the tender documents as appeared in the website/ issued by you and in case of such observance at any stage, it shall be treated as null and void.

We hereby confirm that we have not taken any deviation from tender clauses together with other references as enumerated in the above referred NIT. We hereby confirm our unqualified acceptance to all terms & conditions, unqualified compliance to technical specification, integrity pact (if applicable) and acceptance to reverse auctioning process.

In the event of observance of any deviation in any part of our offer at a later date whether implicit or explicit, the deviations shall stand null & void.

We confirm to have submitted offer in accordance with tender instructions and as per aforesaid references.

Thanking you,

Yours faithfully,

(Signature, date & seal of authorized  
representative of the bidder)