

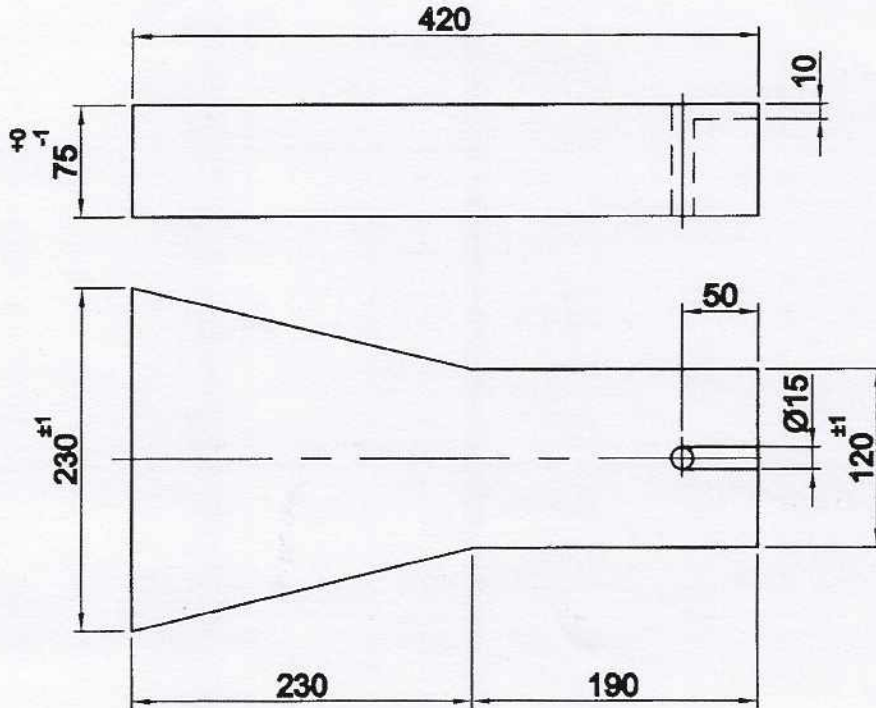



CAUTION: THE INFORMATION ON THIS DOCUMENT IS THE PROPERTY OF BHARAT HEAVY ELECTRICALS LTD  
IT MUST NOT BE DIRECTLY OR INDIRECTLY IN ANYWAY DETERMINAL TO INTEREST OF THE COMPANY

REV	DATE	ALTERED
		CHECKED
		APPROVED



**NOTES:**

- 1) THE REFRACTORIES SHALL BE COMPACT, OF HOMOGENEOUS TEXTURE AND FREE FROM CRACKS, VOIDS AND OTHER FLAWS. THEY SHALL BE BURNT EVENLY THROUGHOUT AND SHALL HAVE SUFFICIENT MECHANICAL STRENGTH AND NO SOFT CORNERS.
- 2) ALL CORNERS TO BE MIN. 5mmRADI.

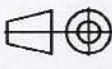
					55%-60% AL <sub>2</sub> O <sub>3</sub>	400	
ITEM NO	DESCRIPTION	DRAWING NO			MATL CODE	UNIT WT	
					MATL SPEC	QTY	
EQPT: <b>ROTARY HEARTH FURNACE</b>							
		Bharat Heavy Electricals Ltd SEAMLESS STEEL TUBE PLANT TIRUCHIRAPALLI - 620014		DRN	NAME P. RAMAKRISHNAN	SIGNATURE <i>P. Ramakrishnan</i>	DATE 29.12.04
				CHD	SSNJKUMAR	<i>S. Sankar</i>	1/1/05
				APPD	S.SHANMUGABUNDARAM	<i>S. Shanmugabundaram</i>	01/01/05
DEPT MPG	GRADE OF UNTOL DIM C/M/F		SCALE 1:5	WEIGHT (Kg) 11.8	REF TO ASSY DRG	ITEM NO	
CODE					REF TO OLD DRG 358105 1/2-11		
TITLE <b>ANCHOR BRICK</b>				CARD CODE U 01	DRAWING NO : <b>4-7-1101-01-06311</b>		REV <b>00</b>

CAUTION: THE INFORMATION ON THIS DOCUMENT IS THE PROPERTY OF BHARAT HEAVY ELECTRICALS LTD  
IT MUST NOT BE USED DIRECTLY OR INDIRECTLY IN ANYWAY DETERMINANT TO INTEREST OF THE COMPANY

ALL DIMENSIONS ARE IN MM

REV 01	DATE	ALTERED
		CHECKED
		APPROVED

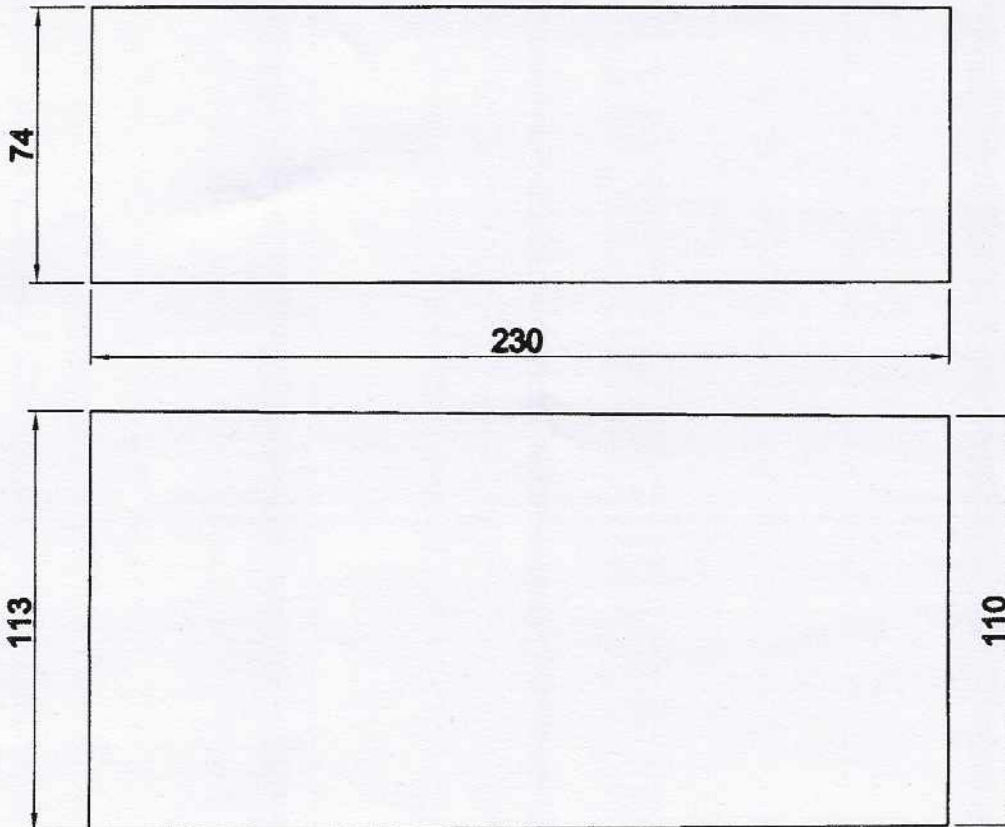

**NOTES:**

- 1) THE REFRACTORIES SHALL BE COMPACT, OF HOMOGENEOUS TEXTURE AND FREE FROM CRACKS, VOIDS AND OTHER FLAWS. THEY SHALL BE BURNT EVENLY THROUGHOUT AND SHALL HAVE SUFFICIENT MECHANICAL STRENGTH AND NO SOFT CORNERS.
- 2) ALL CORNERS TO BE MIN. 5mm RADII.

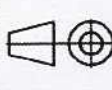
					55%-80% AL <sub>2</sub> O <sub>3</sub>	6050	
ITEM NO	DESCRIPTION	DRAWING NO			MATL CODE	UNIT WT	
					MATL SPEC	QTY	
<b>EQPT: ROTARY HEARTH FURNACE</b>							
		Bharat Heavy Electricals Ltd SEAMLESS STEEL TUBE PLANT TIRUCHIRAPALLI - 620014		DRN	NAME P. RAMAKRISHNAN	SIGNATURE <i>[Signature]</i>	DATE 29.12.04
				CHD	SSN.KUMAR	<i>[Signature]</i>	1/1/05
				APPD	S.SHANMUGASUNDARAM	<i>[Signature]</i>	01/01/05
DEPT MPG	GRADE OF UNTOL DIM C/M/F		SCALE 1:2	WEIGHT (Kg) 4.8	REF TO ASSY DRG	ITEM NO	
CODE					REF TO OLD DRG 368106 1/2-1		
TITLE OUTER WALL SUPPORTING BRICK-I				CARD CODE U 01	DRAWING NO : 4-7-1101-01-06301		REV 00

CAUTION: THE INFORMATION ON THIS DOCUMENT IS THE PROPERTY OF BHARAT HEAVY ELECTRICALS LTD  
IT MUST NOT BE USED DIRECTLY OR INDIRECTLY IN ANYWAY DETERMINAL TO INTEREST OF THE COMPANY

ALL DIMENSIONS ARE IN MM

REV	DATE	ALTERED
01		CHECKED
		APPROVED

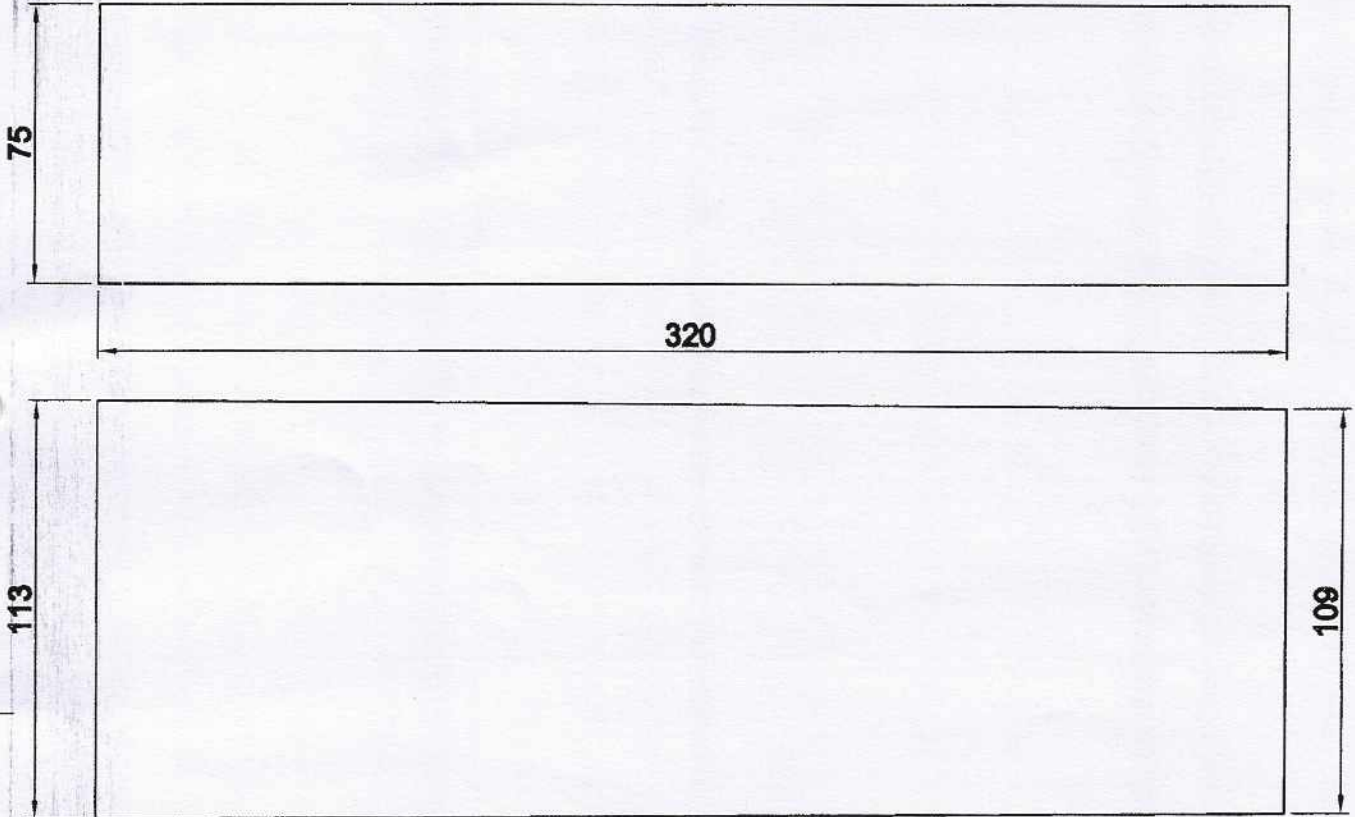

**NOTES:**

- 1) THE REFRACTORIES SHALL BE COMPACT, OF HOMOGENEOUS TEXTURE AND FREE FROM CRACKS, VOIDS AND OTHER FLAWS. THEY SHALL BE BURNT EVENLY THROUGHOUT AND SHALL HAVE SUFFICIENT MECHANICAL STRENGTH AND NO SOFT CORNERS.
- 2) ALL CORNERS TO BE MIN. 5mmRADI.

			55%-60% AL <sub>2</sub> O <sub>3</sub>	1290
ITEM NO	DESCRIPTION	DRAWING NO	MATL CODE	UNIT WT
			MATL SPEC	QTY

EQPT: **ROTARY HEARTH FURNACE**



Bharat Heavy Electricals Ltd  
SEAMLESS STEEL TUBE PLANT  
TIRUCHIRAPALLI - 620014

DRN	NAME	SIGNATURE	DATE
	P. RAMAKRISHNAN	<i>[Signature]</i>	29.12.04
CHD	SSN.KUMAR	<i>[Signature]</i>	1/1/05
APPD	S.SHANMUGASUNDARAM	<i>[Signature]</i>	01/01/05

DEPT	GRADE OF UNTOLED DIM	SCALE	WEIGHT (Kg)	REF TO ASSY DRG	ITEM NO
MPG	C/M/F	1:2	6.7	REF TO OLD DRG	
CODE				368105 1/2-2	

TITLE	CARD CODE	DRAWING NO :	REV
OUTER WALL SUPPORTING BRICK-II	U 01	4-7-1101-01-06302	00

CAUTION: THE INFORMATION ON THIS DOCUMENT IS THE PROPERTY OF BHARAT HEAVY ELECTRICALS LTD  
IT MUST NOT BE REPRODUCED DIRECTLY OR INDIRECTLY IN ANYWAY DETERMINANT TO INTEREST OF THE COMPANY

REV	DATE	ALTERED
01		CHECKED
		APPROVED

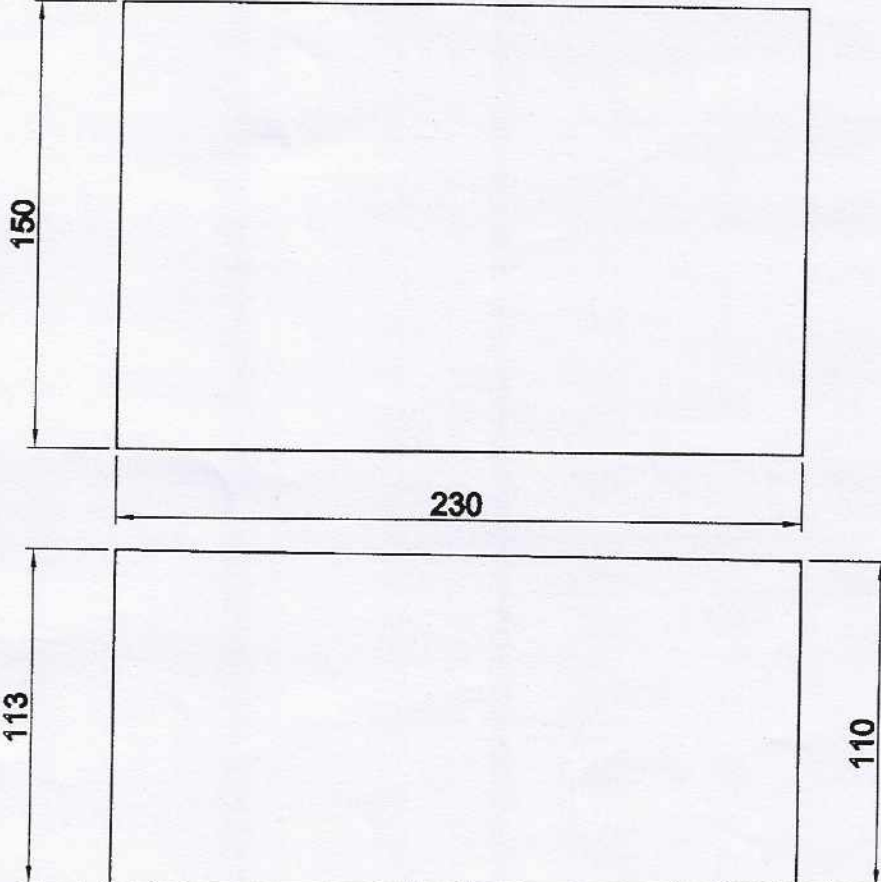

**NOTES:**

- 1) THE REFRACTORIES SHALL BE COMPACT, OF HOMOGENEOUS TEXTURE AND FREE FROM CRACKS, VOIDS AND OTHER FLAWS. THEY SHALL BE BURNT EVENLY THROUGHOUT AND SHALL HAVE SUFFICIENT MECHANICAL STRENGTH AND NO SOFT CORNERS.
- 2) ALL CORNERS TO BE MIN. 5mmRADII.

			55%-60% AL <sub>2</sub> O <sub>3</sub>	455
ITEM NO	DESCRIPTION	DRAWING NO	MATL CODE	UNIT WT
			MATL SPEC	QTY

EQPT: **ROTARY HEARTH FURNACE**



Bharat Heavy Electricals Ltd  
SEAMLESS STEEL TUBE PLANT  
TIRUCHIRAPALLI - 620014

DRN	NAME P. RAMAKRISHNAN	SIGNATURE	DATE 29.12.04
CHD	SSN.KUMAR	SIGNATURE	1/1/05
APPD	B.SHANMUGASUNDARAM	SIGNATURE	01/01/05

DEPT MPG	GRADE OF UNTOL DIM C/M/F		SCALE 1:2.5	WEIGHT (Kg) 9.6	REF TO ASSY DRG	ITEM NO
CODE					REF TO OLD DRG 358105 1/2-3	
TITLE <b>OUTER WALL SUPPORTING BRICK-III</b>				CARD CODE U 01	DRAWING NO : <b>4-7-1101-01-06303</b>	REV <b>00</b>

CAUTION: THE INFORMATION ON THIS DOCUMENT IS THE PROPERTY OF BHARAT HEAVY ELECTRICALS LTD  
IT MUST NOT BE USED DIRECTLY OR INDIRECTLY IN ANYWAY DETERMINAL TO INTEREST OF THE COMPANY

ALL DIMENSIONS ARE IN MM

REV 01	DATE	ALTERED
		CHECKED
		APPROVED

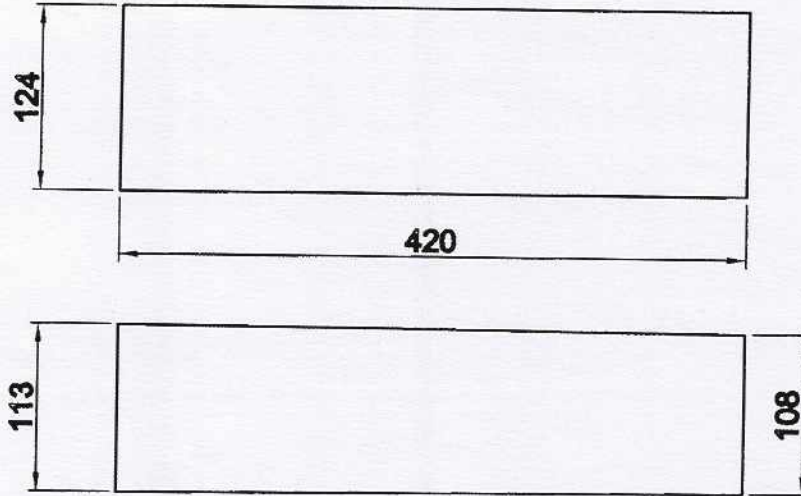

**NOTES:**

- 1) THE REFRACTORIES SHALL BE COMPACT, OF HOMOGENEOUS TEXTURE AND FREE FROM CRACKS, VOIDS AND OTHER FLAWS. THEY SHALL BE BURNT EVENLY THROUGHOUT AND SHALL HAVE SUFFICIENT MECHANICAL STRENGTH AND NO SOFT CORNERS.
- 2) ALL CORNERS TO BE MIN. 5mmRADI.

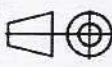
				55%-60% AL <sub>2</sub> O <sub>3</sub>		730	
ITEM NO	DESCRIPTION	DRAWING NO		MATL CODE		UNIT WT	
				MATL SPEC		QTY	
EQPT: <b>ROTARY HEARTH FURNACE</b>							
 Bharat Heavy Electricals Ltd SEAMLESS STEEL TUBE PLANT TIRUCHIRAPALLI - 620014		DRN	NAME P. RAMAKRISHNAN	SIGNATURE <i>P. Ramakrishnan</i>	DATE 29.12.04		
		CHD	SSN.KUMAR	<i>S. Shanmugasundaram</i>	1/1/05		
		APPD	S.SHANMUGASUNDARAM	<i>S. Shanmugasundaram</i>	01/01/05		
DEPT MPG	GRADE OF UNTOLE DIM C/M/F		SCALE 1:5	WEIGHT (Kg) 14.5	REF TO ASSY DRG		ITEM NO
CODE					REF TO OLD DRG 358105 1/2-4		
TITLE <b>OUTER WALL SUPPORTING BRICK-IV</b>				CARD CODE U 01	DRAWING NO : <b>4-7-1101-01-06304</b>		REV <b>00</b>

CAUTION: THE INFORMATION ON THIS DOCUMENT IS THE PROPERTY OF BHAKA HEAVY ELECTRICALS LTD IT MUST NOT BE USED DIRECTLY OR INDIRECTLY IN ANYWAY DETERMINAL TO INTEREST OF THE COMPANY

REV	DATE	ALTERED
		CHECKED
		APPROVED

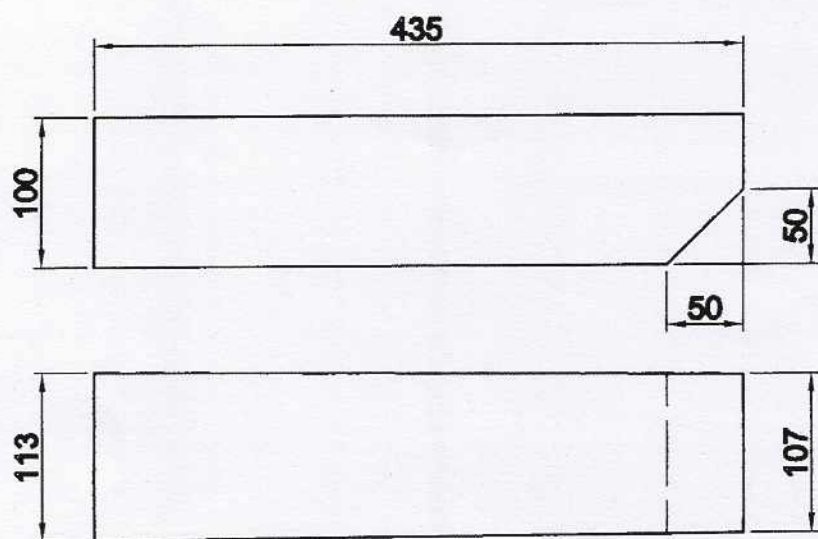

**NOTES:**

- 1) THE REFRACTORIES SHALL BE COMPACT, OF HOMOGENEOUS TEXTURE AND FREE FROM CRACKS, VOIDS AND OTHER FLAWS. THEY SHALL BE BURNT EVENLY THROUGHOUT AND SHALL HAVE SUFFICIENT MECHANICAL STRENGTH AND NO SOFT CORNERS.
- 2) ALL CORNERS TO BE MIN. 5mmRADII.

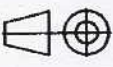
				55%-60% AL <sub>2</sub> O <sub>3</sub>		460	
ITEM NO	DESCRIPTION	DRAWING NO	MATL CODE		UNIT WT		
			MATL SPEC		QTY		
EQPT: ROTARY HEARTH FURNACE							
 Bharat Heavy Electricals Ltd SEAMLESS STEEL TUBE PLANT TIRUCHIRAPALLI - 620014		DRN	NAME P. RAMAKRISHNAN	SIGNATURE <i>[Signature]</i>	DATE 29.12.04		
		CHD	SSN.KUMAR	<i>[Signature]</i>	1/1/05		
		APPD	S.SHANMUGASUNDARAM	<i>[Signature]</i>	01/01/05		
DEPT MPG	GRADE OF UNTOL. DIM C/M/F	 SCALE 1:5	WEIGHT (Kg) 12.56	REF TO ASSY DRG			ITEM NO
CODE				REF TO OLD DRG 358105 1/2-6			
TITLE OUTER WALL BASE BRICK-I			CARD CODE U 01	DRAWING NO : 4-7-1101-01-06306			REV 00

CAUTION: THE INFORMATION ON THIS DOCUMENT IS THE PROPERTY OF BHARAT HEAVY ELECTRICALS L.TD  
IT MUST NOT BE USED DIRECTLY OR INDIRECTLY IN ANYWAY DETERMINAL TO INTEREST OF THE COMPANY

KEY Q1	DATE	ALTERED
		CHECKED
		APPROVED

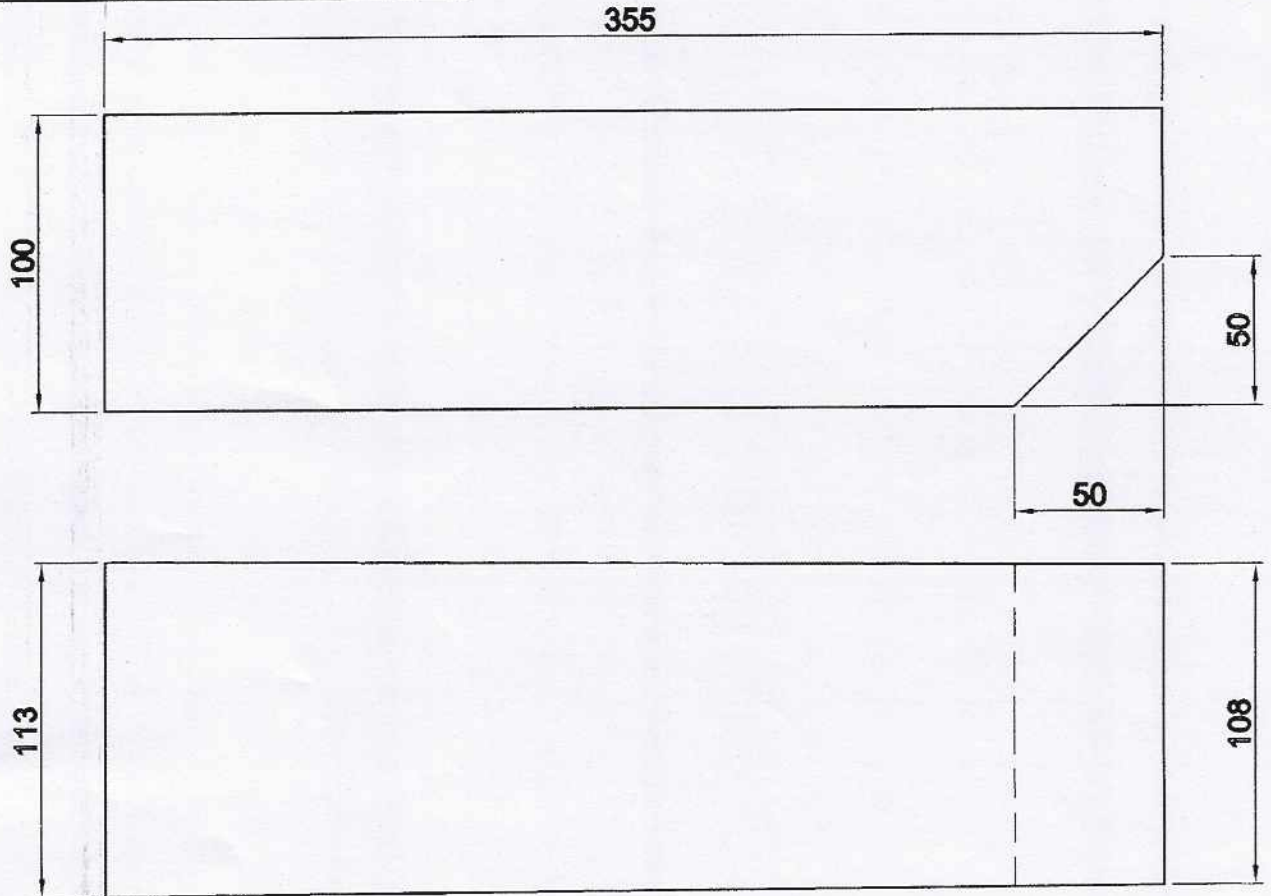

**NOTES:**

- 1) THE REFRACTORIES SHALL BE COMPACT, OF HOMOGENEOUS TEXTURE AND FREE FROM CRACKS, VOIDS AND OTHER FLAWS. THEY SHALL BE BURNT EVENLY THROUGHOUT AND SHALL HAVE SUFFICIENT MECHANICAL STRENGTH AND NO SOFT CORNERS.
- 2) ALL CORNERS TO BE MIN. 5mmRADII.

			55%-60% AL <sub>2</sub> O <sub>3</sub>	460
ITEM NO	DESCRIPTION	DRAWING NO	MATL CODE	UNIT WT
			MATL SPEC	QTY

EQPT: **ROTARY HEARTH FURNACE**

 Bharat Heavy Electricals Ltd SEAMLESS STEEL TUBE PLANT TIRUCHIRAPALLI - 620014	DRN	NAME P. RAMAKRISHNAN	SIGNATURE <i>P. Ramakrishnan</i>	DATE 29.12.04
	CHD	SSN.KUMAR	<i>S. Shanmugasundaram</i>	1/1/05
	APPD	B.SHANMUGASUNDARAM	<i>B. Shanmugasundaram</i>	01/01/05

DEPT MPG	GRADE OF UNTOL DIM C/M/F		SCALE 1:2.5	WEIGHT (Kg) 10.3	REF TO ASSY DRG	ITEM NO
CODE					REF TO OLD DRG 358105 1/2-7	

TITLE <b>OUTER WALL BASE BRICK-II</b>	CARD CODE U 01	DRAWING NO : <b>4-7-1101-01-06307</b>	REV <b>00</b>
--	----------------------	--	------------------

CAUTION: THE INFORMATION ON THIS DOCUMENT IS THE PROPERTY OF BHARAT HEAVY ELECTRICALS LTD. IT MUST NOT BE USED DIRECTLY OR INDIRECTLY IN ANYWAY DETERMINANT TO INTEREST OF THE COMPANY

REV	DATE	ALTERED
01		CHECKED
		APPROVED

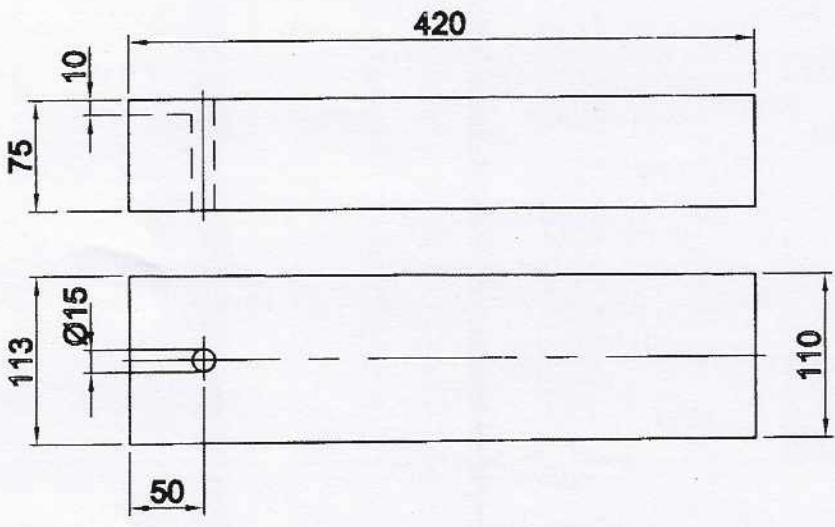

**NOTES:**

- 1) THE REFRACTORIES SHALL BE COMPACT, OF HOMOGENEOUS TEXTURE AND FREE FROM CRACKS, VOIDS AND OTHER FLAWS. THEY SHALL BE BURNT EVENLY THROUGHOUT AND SHALL HAVE SUFFICIENT MECHANICAL STRENGTH AND NO SOFT CORNERS.
- 2) ALL CORNERS TO BE MIN. 5mm RADII.

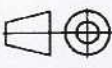
				55%-60% AL <sub>2</sub> O <sub>3</sub>	94
ITEM NO	DESCRIPTION	DRAWING NO		MATL CODE	UNIT WT
				MATL SPEC	QTY
EQPT: ROTARY HEARTH FURNACE					
 Bharat Heavy Electricals Ltd SEAMLESS STEEL TUBE PLANT TIRUCHIRAPALLI - 620014		DRN	NAME P. RAMAKRISHNAN	SIGNATURE <i>[Signature]</i>	DATE 29.12.04
		CHD	SSN.KUMAR	<i>[Signature]</i>	11/1/05
		APPD	S.SHANMUGASUNDARAM	<i>[Signature]</i>	01/01/05
DEPT MPG	GRADE OF UNTOL. DIM C/M/F		SCALE 1:2.5	WEIGHT (Kg) 8.78	REF TO ASSY DRG
CODE					REF TO OLD DRG 358105 1/2-8
TITLE OUTER WALL ANCHOR BRICK-I				CARD CODE U 01	DRAWING NO : 4-7-1101-01-06308
					REV 00

CAUTION: THE INFORMATION ON THIS DOCUMENT IS THE PROPERTY OF BHARAT HEAVY ELECTRICALS LTD. IT MUST NOT BE USED DIRECTLY OR INDIRECTLY IN ANYWAY DETERMINAL TO INTEREST OF THE COMPANY

REV 01	DATE	ALTERED
		CHECKED
		APPROVED

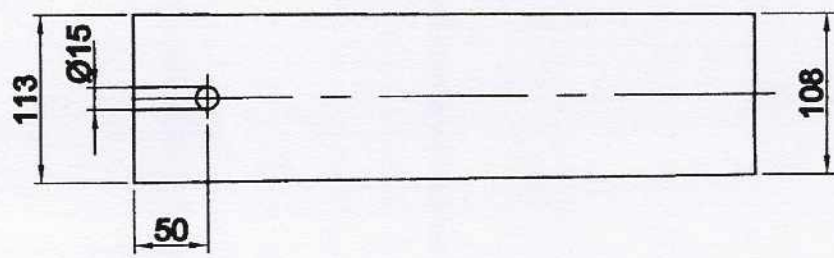
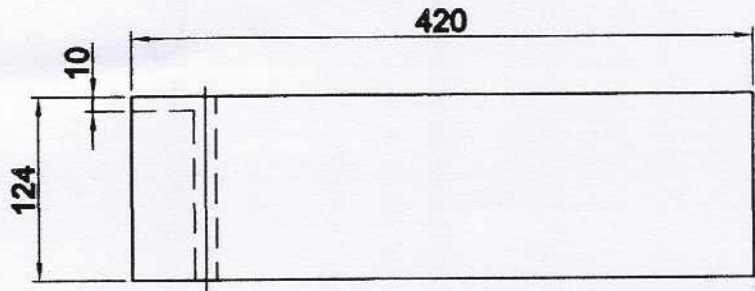

**NOTES:**

- 1) THE REFRACTORIES SHALL BE COMPACT, OF HOMOGENEOUS TEXTURE AND FREE FROM CRACKS, VOIDS AND OTHER FLAWS. THEY SHALL BE BURNT EVENLY THROUGHOUT AND SHALL HAVE SUFFICIENT MECHANICAL STRENGTH AND NO SOFT CORNERS.**
- 2) ALL CORNERS TO BE MIN. 5mmRADII.**

			55%-60% AL <sub>2</sub> O <sub>3</sub>	190
ITEM NO	DESCRIPTION	DRAWING NO	MATL CODE	UNIT WT
			MATL SPEC	QTY

EQPT: **ROTARY HEARTH FURNACE**



**Bharat Heavy Electricals Ltd**  
SEAMLESS STEEL TUBE PLANT  
TIRUCHIRAPALLI - 620014

DRN	NAME <b>P. RAMAKRISHNAN</b>	SIGNATURE <i>P. Ramakrishnan</i>	DATE <b>29.12.04</b>
CHD	<b>SBN.KUMAR</b>	<i>S. Sankar</i>	<b>11/1/05</b>
APPD	<b>S.SHANMUGASUNDARAM</b>	<i>S. Shanmugasundaram</i>	<b>01/01/05</b>

DEPT <b>MPG</b>	GRADE OF UNTOL DIM <b>C/M/F</b>		SCALE <b>1:2.5</b>	WEIGHT (Kg) <b>14.5</b>	REF TO ASSY DRG	ITEM NO
CODE					REF TO OLD DRG <b>358105 1/2-9</b>	

TITLE <b>OUTER WALL ANCHOR BRICK-II</b>	CARD CODE <b>U 01</b>	DRAWING NO : <b>4-7-1101-01-06309</b>	REV <b>00</b>
--	--------------------------	--	------------------

ALL DIMENSIONS ARE IN MM

CAUTION: THE INFORMATION ON THIS DOCUMENT IS THE PROPERTY OF BHARAT HEAVY ELECTRICALS LTD  
IT MUST NOT BE USED DIRECTLY OR INDIRECTLY IN ANYWAY DETERMINAL TO INTEREST OF THE COMPANY

REV 01	DATE	ALTERED
		CHECKED
		APPROVED

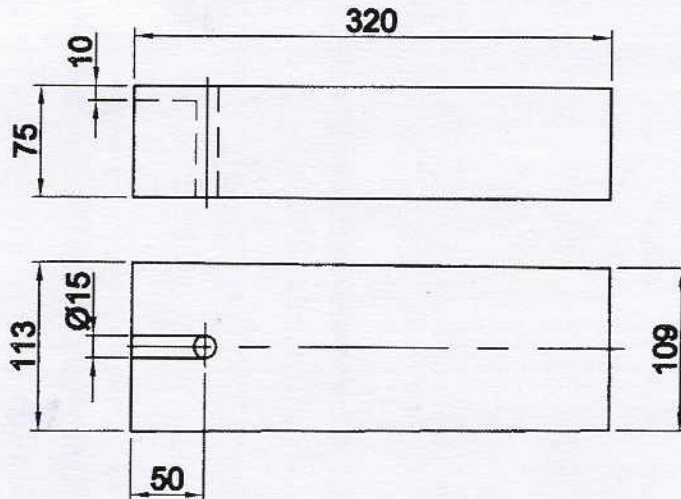

**NOTES:**

- 1) THE REFRACTORIES SHALL BE COMPACT, OF HOMOGENEOUS TEXTURE AND FREE FROM CRACKS, VOIDS AND OTHER FLAWS. THEY SHALL BE BURNT EVENLY THROUGHOUT AND SHALL HAVE SUFFICIENT MECHANICAL STRENGTH AND NO SOFT CORNERS.
- 2) ALL CORNERS TO BE MIN. 5mmRADI.

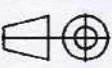
				55%-60% AL <sub>2</sub> O <sub>3</sub>		94	
ITEM NO	DESCRIPTION	DRAWING NO		MATL CODE		UNIT WT	
				MATL SPEC		QTY	
EQPT: <b>ROTARY HEARTH FURNACE</b>							
		Bharat Heavy Electricals Ltd SEAMLESS STEEL TUBE PLANT TIRUCHIRAPALLI - 620014		DRN	NAME P. RAMAKRISHNAN	SIGNATURE <i>P. Ramakrishnan</i>	DATE 29.12.04
				CHD	SSN.KUMAR	<i>S. Shanmugasundaram</i>	1/1/05
				APPD	S.SHANMUGASUNDARAM	<i>S. Shanmugasundaram</i>	01/01/05
DEPT MPG	GRADE OF UNTOL. DIM C/M/F		SCALE 1:5	WEIGHT (Kg) 6.8	REF TO ASSY DRG		ITEM NO
CODE					REF TO OLD DRG 358105 1/2-10		
TITLE <b>OUTER WALL ANCHOR BRICK-III</b>				CARD CODE U 01	DRAWING NO : <b>4-7-1101-01-06310</b>		REV <b>00</b>

3

CAUTION: THE INFORMATION ON THIS DOCUMENT IS THE PROPERTY OF BHARAT HEAVY ELECTRICALS LTD  
IT MUST NOT BE USED DIRECTLY OR INDIRECTLY IN ANYWAY DETERMINAL TO INTEREST OF THE COMPANY

REV	DATE	ALTERED
01		CHECKED
		APPROVED

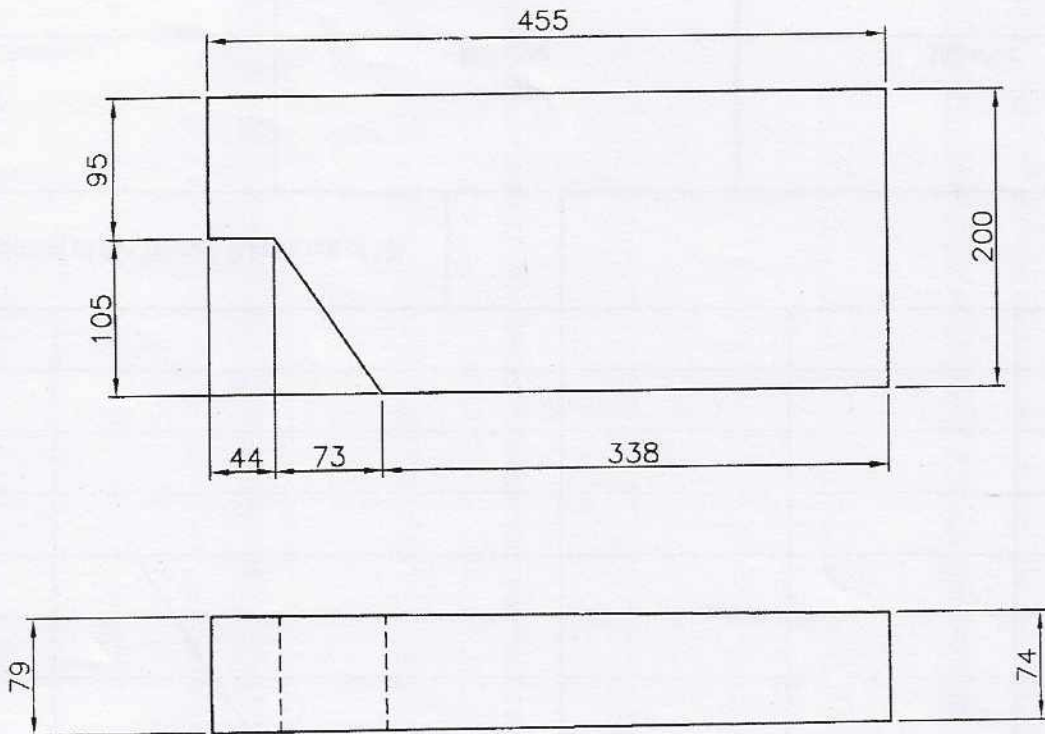

**NOTES:**

1. THE REFRACTORIES SHALL BE COMPACT, OF HOMOGENEOUS TEXTURE AND FREE FROM CRACKS, VOIDS AND OTHER FLAWS, THEY SHALL BE BURNT EVENLY THROUGHOUT, AND SHALL HAVE SUFFICIENT MECHANICAL STRENGTH AND NO SOFT CORNERS.
2. ALL CORNERS TO BE MINIMUM 3 mm. RADII, UNLESS OTHERWISE STATED.
3. TOLERANCE ON SIZE  $\begin{matrix} +0 \\ -1 \end{matrix}$

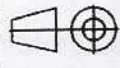
				80% AL <sub>2</sub> O <sub>3</sub>	600
ITEM NO	DESCRIPTION	DRAWING NO		MATL CODE	UNIT WT
				MATL SPEC	QTY
EQPT: ROTARY HEARTH FURNACE					
 Bharat Heavy Electricals Ltd SEAMLESS STEEL TUBE PLANT TIRUCHIRAPALLI - 620014		DRN	NAME SSN.KUMAR	SIGNATURE <i>S.S.N. Kumar</i>	DATE 15.12.04
		CHD			
		APPD	S.SHANMUGASUNDARAM	<i>S. Shanmugasundaram</i>	16/12/04
DEPT MPG	GRADE OF UNTOL. DIM ϕ/M/F		SCALE 1:5	WEIGHT (Kg) 17.6	REF TO ASSY DRG
CODE					REF TO OLD DRG FA-0427-3/2
TITLE HEARTH TOP OUTER SLAB BLOCK				CARD CODE U 01	DRAWING NO : 4-7-1101-01-06278
					ITEM NO REV 00

CAUTION: THE INFORMATION ON THIS DOCUMENT IS THE PROPERTY OF BHARAT HEAVY ELECTRICALS LTD IT MUST NOT BE REPRODUCED DIRECTLY OR INDIRECTLY IN ANYWAY DETERMINAL TO INTEREST OF THE COMPANY.

ALL DIMENSIONS ARE IN MM

REV	DATE	ALTERED
01		CHECKED
		APPROVED

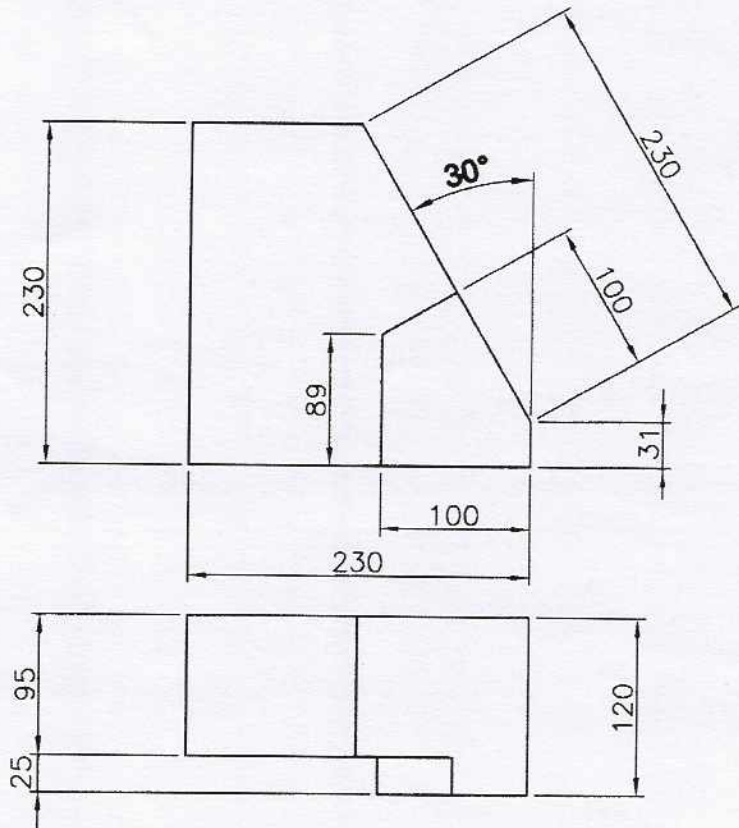

**NOTES:**

1. THE REFRACTORIES SHALL BE COMPACT, OF HOMOGENEOUS TEXTURE AND FREE FROM CRACKS, VOIDS AND OTHER FLAWS, THEY SHALL BE BURNT EVENLY THROUGHOUT, AND SHALL HAVE SUFFICIENT MECHANICAL STRENGTH AND NO SOFT CORNERS.
2. ALL CORNERS TO BE MINIMUM 3 mm. RADII, UNLESS OTHERWISE STATED.
3. TOLERANCE ON SIZE  $\begin{matrix} +0 \\ -1 \end{matrix}$

ITEM NO	DESCRIPTION	DRAWING NO	55-60% AL <sub>2</sub> O <sub>3</sub>	2
			MATL CODE	UNIT WT
			MATL SPEC	QTY

EQPT: **ROTARY HEARTH FURNACE**



Bharat Heavy Electricals Ltd  
SEAMLESS STEEL TUBE PLANT  
TIRUCHIRAPALLI - 620014

DRN	NAME SSN.KUMAR	SIGNATURE SSN.Kumar	DATE 15.12.04
CHD			
APPD	S.SHANMUGASUNDARAM	S. Shanmugam	16/12/04

DEPT MPG	GRADE OF UNTOL DIM G/M/F		SCALE 1:5	WEIGHT (Kg) 10	REF TO ASSY DRG	ITEM NO
CODE					REF TO OLD DRG FA-0427-3/8	
TITLE <b>SKEW BACK-R.H CHARGING &amp; DISCHARGING DOORS</b>				CARD CODE U 01	DRAWING NO : <b>4-7-1101-01-06284</b>	REV <b>00</b>

ALL DIMENSIONS ARE IN MM

CAUTION: THE INFORMATION ON THIS DOCUMENT IS THE PROPERTY OF BHARAT HEAVY ELECTRICALS LTD IT MUST NOT BE U DIRECTLY OR INDIRECTLY IN ANYWAY DETERMINANT TO INTEREST OF THE COMPANY

REV 01	DATE	ALTERED
		CHECKED
		APPROVED

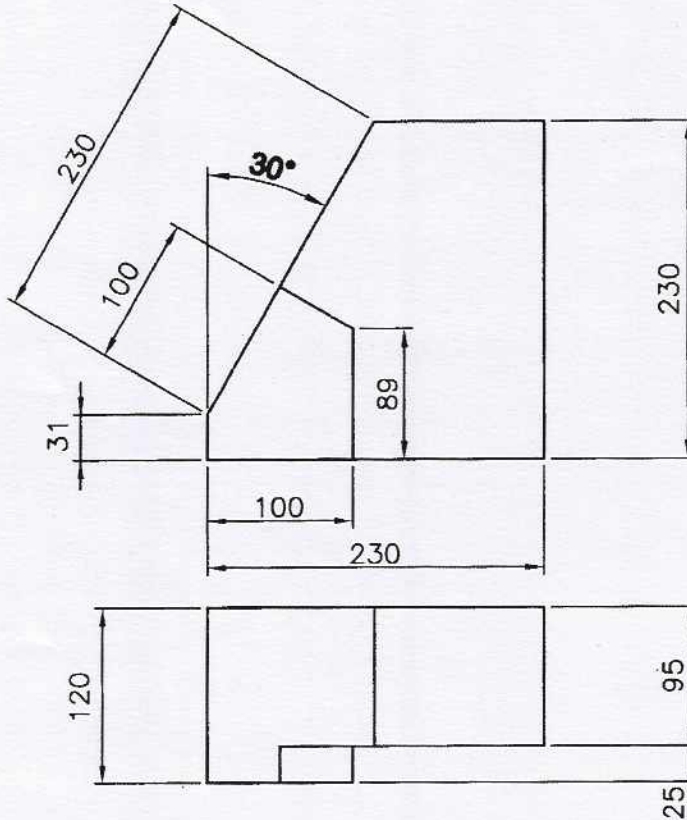

**NOTES:**

1. THE REFRACTORIES SHALL BE COMPACT, OF HOMOGENEOUS TEXTURE AND FREE FROM CRACKS, VOIDS AND OTHER FLAWS, THEY SHALL BE BURNT EVENLY THROUGHOUT, AND SHALL HAVE SUFFICIENT MECHANICAL STRENGTH AND NO SOFT CORNERS.
2. ALL CORNERS TO BE MINIMUM 3 mm.RADII, UNLESS OTHERWISE STATED.
3. TOLERANCE ON SIZE  $\begin{matrix} +0 \\ -1 \end{matrix}$

			55-60% AL <sub>2</sub> O <sub>3</sub>	2
ITEM NO	DESCRIPTION	DRAWING NO	MATL CODE	UNIT WT
			MATL SPEC	QTY

EQPT: **ROTARY HEARTH FURNACE**

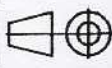
	Bharat Heavy Electricals Ltd SEAMLESS STEEL TUBE PLANT TIRUCHIRAPALLI - 620014		DRN	NAME SSN.KUMAR	SIGNATURE <i>SSN.Kumar</i>	DATE 15.12.04
			CHD			
			APPD	S.SHANMUGASUNDARAM	<i>S. Shanmugasundaram</i>	16/12/04
DEPT MPG	GRADE OF UNTOL DIM E/M/F	 SCALE 1:5	WEIGHT (Kg) 10	REF TO ASSY DRG		ITEM NO
CODE				REF TO OLD DRG <b>FA-0427-3/9</b>		
TITLE <b>SKEW BACK-L.H CHARGING &amp; DISCHARGING DOORS</b>			CARD CODE U 01	DRAWING NO : <b>4-7-1101-01-06285</b>		REV <b>00</b>

CAUTION: THE INFORMATION ON THIS DOCUMENT IS THE PROPERTY OF BHARAT HEAVY ELECTRICALS LTD. IT MUST NOT BE USED DIRECTLY OR INDIRECTLY IN ANYWAY DETERMINANT TO INTEREST OF THE COMPANY.

REV 01	DATE	ALTERED
		CHECKED
		APPROVED

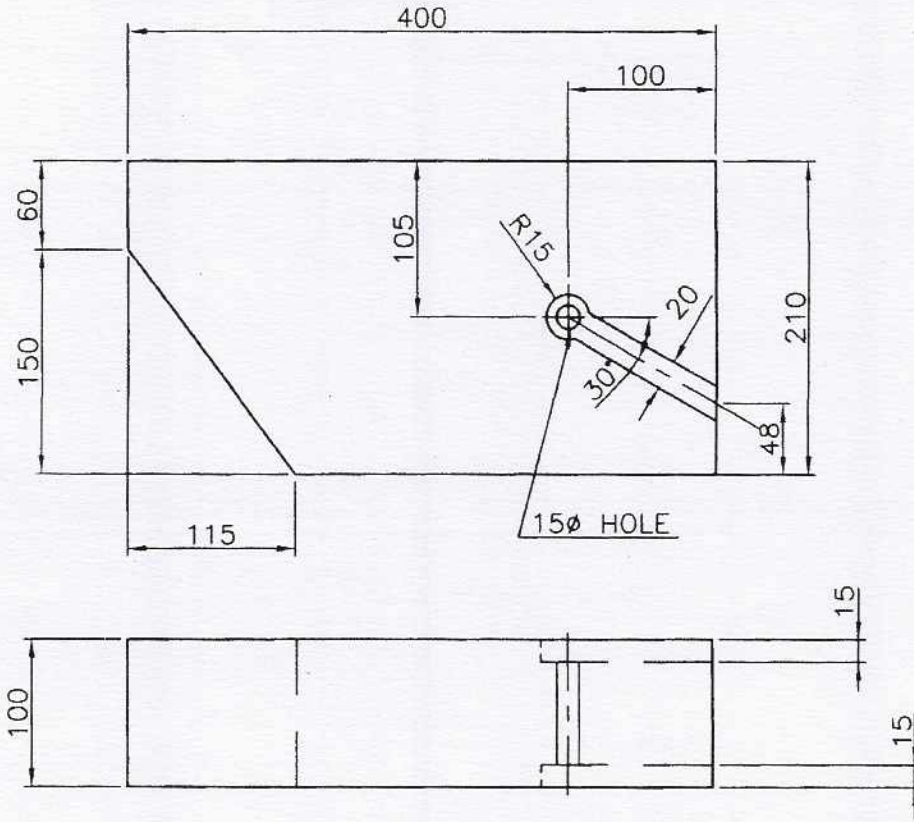

**NOTES:**

1. THE REFRACTORIES SHALL BE COMPACT, OF HOMOGENEOUS TEXTURE AND FREE FROM CRACKS, VOIDS AND OTHER FLAWS, THEY SHALL BE BURNT EVENLY THROUGHOUT, AND SHALL HAVE SUFFICIENT MECHANICAL STRENGTH AND NO SOFT CORNERS.
2. ALL CORNERS TO BE MINIMUM 3 mm. RADII, UNLESS OTHERWISE STATED.
3. TOLERANCE ON SIZE  $\begin{matrix} +0 \\ -1 \end{matrix}$

ITEM NO	DESCRIPTION	DRAWING NO	55-60% AL <sub>2</sub> O <sub>3</sub>	28
			MATL CODE	UNIT WT
			MATL SPEC	QTY

EQPT: **ROTARY HEARTH FURNACE**



Bharat Heavy Electricals Ltd  
SEAMLESS STEEL TUBE PLANT  
TIRUCHIRAPALLI - 620014

DRN	NAME SSN.KUMAR	SIGNATURE SSN.Kumar	DATE 15.12.04
CHD			
APPD	S.SHANMUGASUNDARAM	<i>S. Shanmugasundaram</i>	16/12/04

DEPT MPG	GRADE OF UNTOL. DIM φ/M/T		SCALE 1:5	WEIGHT (Kg) 16.6	REF TO ASSY DRG	ITEM NO
CODE					REF TO OLD DRG FA-0427-3/12	
TITLE <b>SILL BLOCK</b> <b>CHARGING &amp; DISCHARGING DOORS</b>				CARD CODE U 01	DRAWING NO : <b>4-7-1101-01-06288</b>	REV <b>00</b>

CAUTION: THE INFORMATION ON THIS DOCUMENT IS THE PROPERTY OF BHARAT HEAVY ELECTRICALS LTD. IT MUST NOT BE USED DIRECTLY OR INDIRECTLY IN ANYWAY DETERMINAL TO INTEREST OF THE COMPANY.

REV	DATE	ALTERED
		CHECKED
		APPROVED

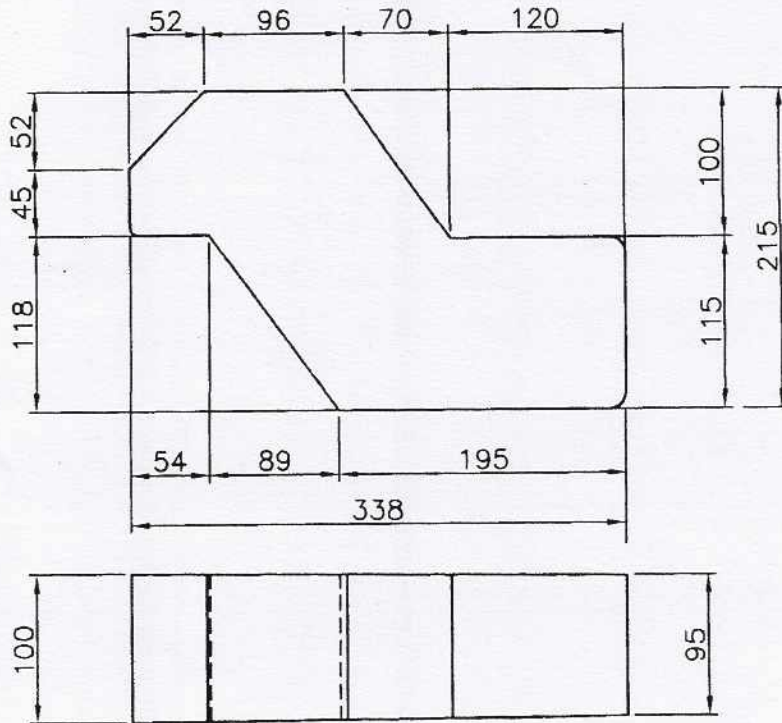

**NOTES:**

1. THE REFRACTORIES SHALL BE COMPACT, OF HOMOGENEOUS TEXTURE AND FREE FROM CRACKS, VOIDS AND OTHER FLAWS, THEY SHALL BE BURNT EVENLY THROUGHOUT, AND SHALL HAVE SUFFICIENT MECHANICAL STRENGTH AND NO SOFT CORNERS.
2. ALL CORNERS TO BE MINIMUM 3 mm. RADII, UNLESS OTHERWISE STATED.
3. TOLERANCE ON SIZE  $\pm 0.1$

ITEM NO	DESCRIPTION	DRAWING NO	80% AL <sub>2</sub> O <sub>3</sub>	480
			MATL CODE	UNIT WT
			MATL SPEC	QTY

EQPT: **ROTARY HEARTH FURNACE**



Bharat Heavy Electricals Ltd  
SEAMLESS STEEL TUBE PLANT  
TIRUCHIRAPALLI - 620014

DRN	NAME	SIGNATURE	DATE
	SSN.KUMAR	SSN.Kumar	15.12.04
CHD			
APPD	S.SHANMUGASUNDARAM	S. Shaylor	16/12/05

DEPT	GRADE OF UNTOL DIM	SCALE	WEIGHT (Kg)	REF TO ASSY DRG	ITEM NO
MPG		1:5	12.5		
CODE				REF TO OLD DRG	
				FA-0427-3/4	

TITLE	CARD CODE	DRAWING NO :	REV
HEARTH MIDDLE OUTER CIRCLE BLOCK	U 01	4-7-1101-01-06280	00

CAUTION: THE INFORMATION ON THIS DOCUMENT IS THE PROPERTY OF BHARAT HEAVY ELECTRICALS LTD. IT MUST NOT BE USED DIRECTLY OR INDIRECTLY IN ANYWAY DETERMINAL TO INTEREST OF THE COMPANY

REV. 01	DATE	ALTERED
		CHECKED
		APPROVED

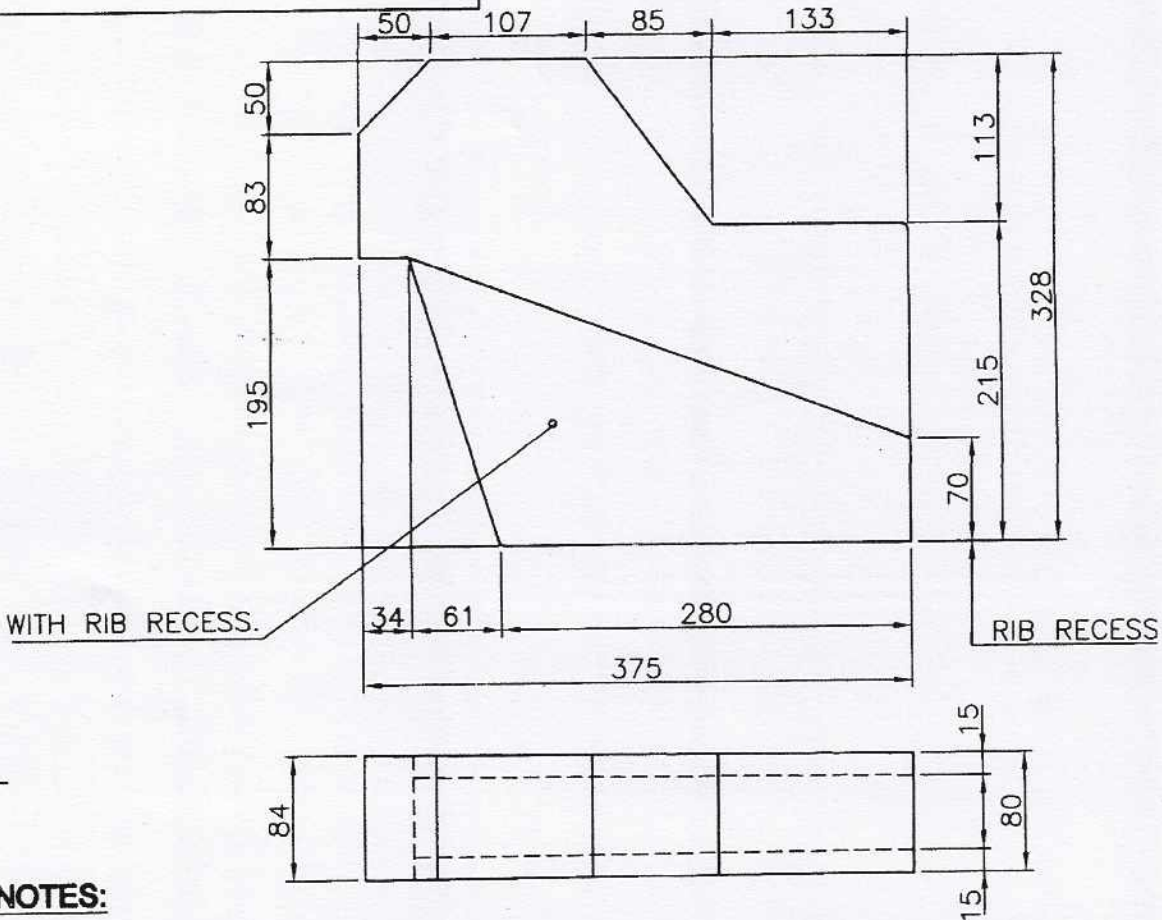

**NOTES:**

1. THE REFRACTORIES SHALL BE COMPACT, OF HOMOGENEOUS TEXTURE AND FREE FROM CRACKS, VOIDS AND OTHER FLAWS, THEY SHALL BE BURNT EVENLY THROUGHOUT, AND SHALL HAVE SUFFICIENT MECHANICAL STRENGTH AND NO SOFT CORNERS.
2. ALL CORNERS TO BE MINIMUM 3 mm. RADII, UNLESS OTHERWISE STATED.
3. TOLERANCE ON SIZE  $\begin{matrix} +0 \\ -1 \end{matrix}$

				80% AL <sub>2</sub> O <sub>3</sub>		576	
ITEM NO	DESCRIPTION	DRAWING NO	MATL CODE		UNIT WT		
			MATL SPEC		QTY		
EQPT: <b>ROTARY HEARTH FURNACE</b>							
		Bharat Heavy Electricals Ltd SEAMLESS STEEL TUBE PLANT TIRUCHIRAPALLI - 620014		DRN	NAME	SIGNATURE	DATE
				CHD	SBN.KUMAR	S.N. Kumar	15.12.04
				APPD	S.SHANMUGASUNDARAM	<i>S. Shanmugasundaram</i>	16/12/04
DEPT	MPG	GRADE OF UNTOL DIM	SCALE	WEIGHT (Kg)	REF TO ASSY DRG		ITEM NO
CODE		φ/M/F	1:5	18.1	REF TO OLD DRG		
						FA-0427-3/6	
TITLE				CARD CODE	DRAWING NO :		REV
HEARTH BOTTOM OUTER CIRCLE BLOCK				U 01	4-7-1101-01-06282		00

FIRST ANGLE PROJECTION (ALL DIMENSIONS IN MILLIMETRES)

S 27-009

CAUTION THE INFORMATION ON THIS DOCUMENT IS THE PROPERTY OF BHARAT HEAVY ELECTRICALS LTD. IT MUST NOT BE USED DIRECTLY OR INDIRECTLY IN ANY WAY DETRIMENTAL TO THE INTEREST OF THE COMPANY.

REV 01	DATE 31-12-01	ALTERED <i>[Signature]</i>
		CHECKED <i>[Signature]</i>
ZONE		APPROVED <i>[Signature]</i>
MATL SPEC REVISED AS PER WESMAN REVISION		

P  
↓

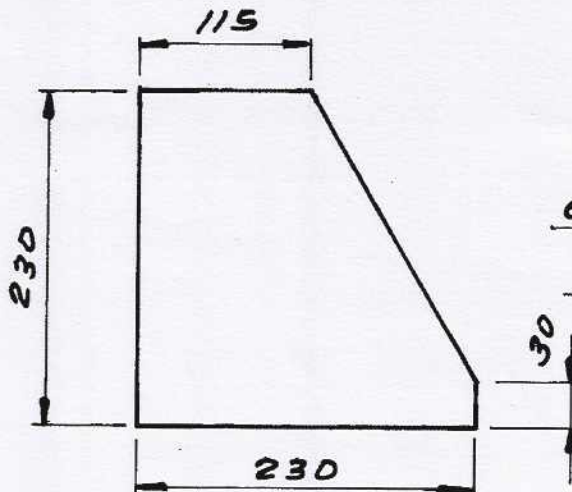
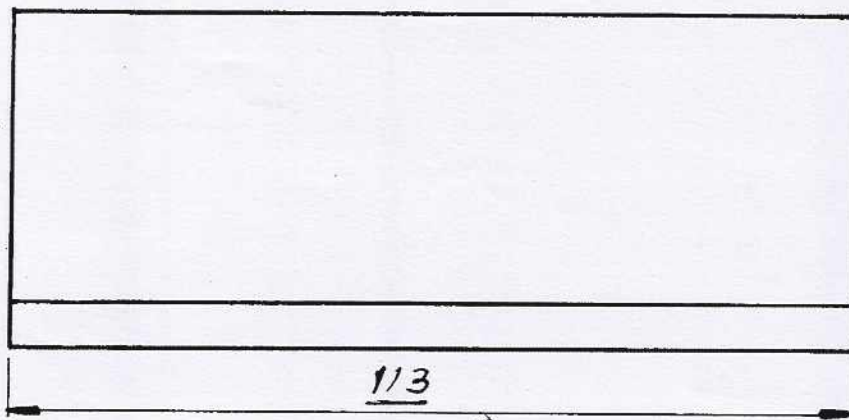

QUALITY:-  
55-60% Al<sub>2</sub>O<sub>3</sub>  
SILLIMANITE.

**VIEW-P**

ITEM NO.	DESCRIPTION	MATL CODE	UNIT WT
		MATL SPEC	QTY

EQPT: RHF



**Bharat Heavy Electricals Ltd.,**  
SEAMLESS STEEL TUBE PLANT  
TIRUCHIRAPALLI-620 014

DRN	NAME SSN.KUMAR	DATE 10.7.91
CHD	<i>[Signature]</i>	11.7.91
APPD	<i>[Signature]</i>	11.7.91

DEPT CODE	GRADE OF LINTOL DIM C/M/E	1:5	WEIGHT (kg)	REF TO ASSY/OLD DRG 4-1101-58-48*	ITEM NO.
--------------	---------------------------------	-----	-------------	--------------------------------------	----------

TITLE <b>SKEW BACK</b>	CARD CODE U 01	DRAWING NO. 4-7-1101-01-0445701	REV.
---------------------------	-------------------	------------------------------------	------

CAUTION: THE INFORMATION ON THIS DOCUMENT IS THE PROPERTY OF BHARAT HEAVY ELECTRICALS LTD  
IT MUST NOT BE I DIRECTLY OR INDIRECTLY IN ANYWAY DETERMINANT TO INTEREST OF THE COMPANY

REV 01	DATE	ALTERED
		CHECKED
		APPROVED

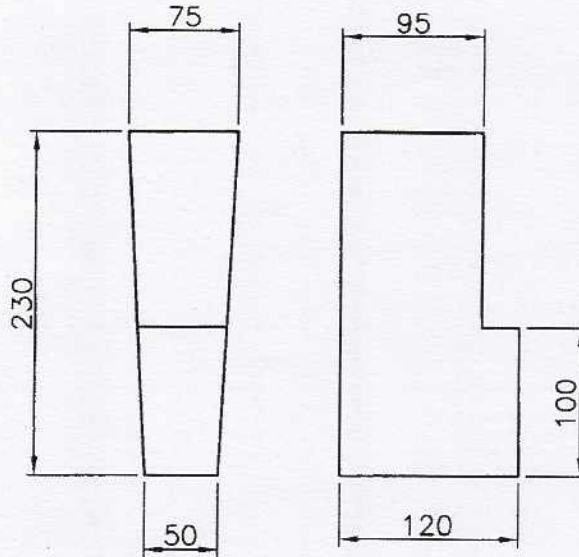

**NOTES:**

1. THE REFRACTORIES SHALL BE COMPACT, OF HOMOGENEOUS TEXTURE AND FREE FROM CRACKS, VOIDS AND OTHER FLAWS, THEY SHALL BE BURNT EVENLY THROUGHOUT, AND SHALL HAVE SUFFICIENT MECHANICAL STRENGTH AND NO SOFT CORNERS.
2. ALL CORNERS TO BE MINIMUM 3 mm. RADII, UNLESS OTHERWISE STATED.
3. TOLERANCE ON SIZE  $\begin{matrix} +0 \\ -1 \end{matrix}$

ITEM NO	DESCRIPTION	DRAWING NO	55-80% AL <sub>2</sub> O <sub>3</sub>	10
			MATL CODE	UNIT WT
			MATL SPEC	QTY

EQPT: **ROTARY HEARTH FURNACE**



Bharat Heavy Electricals Ltd  
SEAMLESS STEEL TUBE PLANT  
TIRUCHIRAPALLI - 620014

DRN	NAME SSN.KUMAR	SIGNATURE SSN.Kumar	DATE 15.12.04
CHD			
APPD	B.SHANMUGASUNDARAM	<i>[Signature]</i>	16/12/04

DEPT MPG	GRADE OF UNTOL DIM E/M/F		SCALE 1:5	WEIGHT (Kg) 3.8	REF TO ASSY DRG	ITEM NO
CODE					REF TO OLD DRG FA-0427-3/10	
TITLE <b>END ARCH CHARGING &amp; DISCHARGING DOORS</b>				CARD CODE U 01	DRAWING NO : <b>4-7-1101-01-06286</b>	REV <b>00</b>

CAUTION: THE INFORMATION ON THIS DOCUMENT IS THE PROPERTY OF BHARAT HEAVY ELECTRICALS LTD IT MUST NOT BE USED DIRECTLY OR INDIRECTLY IN ANYWAY DETERMINANT TO INTEREST OF THE COMPANY

ALL DIMENSIONS ARE IN MM

REV	DATE	ALTERED
01		CHECKED
		APPROVED

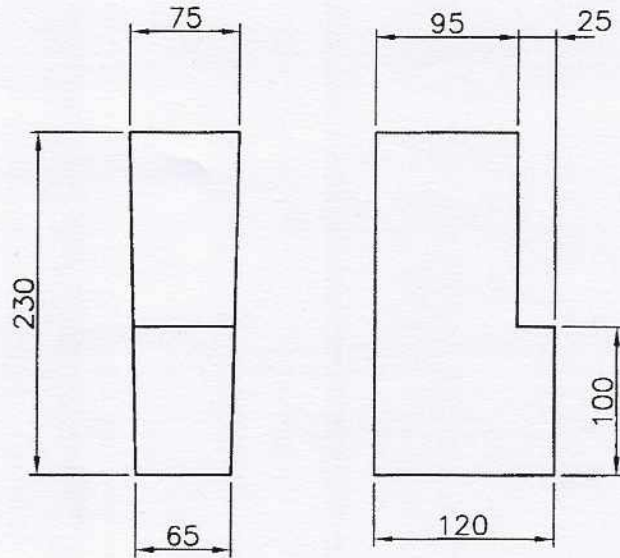

**NOTES:**

1. THE REFRACTORIES SHALL BE COMPACT, OF HOMOGENEOUS TEXTURE AND FREE FROM CRACKS, VOIDS AND OTHER FLAWS, THEY SHALL BE BURNT EVENLY THROUGHOUT, AND SHALL HAVE SUFFICIENT MECHANICAL STRENGTH AND NO SOFT CORNERS.
2. ALL CORNERS TO BE MINIMUM 3 mm. RADII, UNLESS OTHERWISE STATED.
3. TOLERANCE ON SIZE  $\begin{matrix} +0 \\ -1 \end{matrix}$

ITEM NO	DESCRIPTION	DRAWING NO	55-60% AL <sub>2</sub> O <sub>3</sub>	10
			MATL CODE	UNIT WT
			MATL SPEC	QTY

EQPT: **ROTARY HEARTH FURNACE**



Bharat Heavy Electricals Ltd  
SEAMLESS STEEL TUBE PLANT  
TIRUCHIRAPALLI - 620014

DRN	NAME	SIGNATURE	DATE
	SENJUMAR	S. N. Kumar	15.12.04
CHD			
APPD	S. SHANMUGASUNDARAM	S. Shanmugam	16/12/04

DEPT	GRADE OF UNTOL DIM	SCALE	WEIGHT (Kg)	REF TO ASSY DRG	ITEM NO
MPG	φ/M/f	1:5	4.2	REF TO OLD DRG	
CODE				FA-0427-3/11	

TITLE	CARD CODE	DRAWING NO :	REV
END ARCH CHARGING & DISCHARGING DOORS	U 01	4-7-1101-01-06287	00

CAUTION: THE INFORMATION ON THIS DOCUMENT IS THE PROPERTY OF BHARAT HEAVY ELECTRICALS LTD  
IT MUST NOT BE REPRODUCED DIRECTLY OR INDIRECTLY IN ANYWAY DETERMINANT TO INTEREST OF THE COMPANY

ALL DIMENSIONS ARE IN MM

REV	DATE	ALTERED
01		CHECKED
		APPROVED

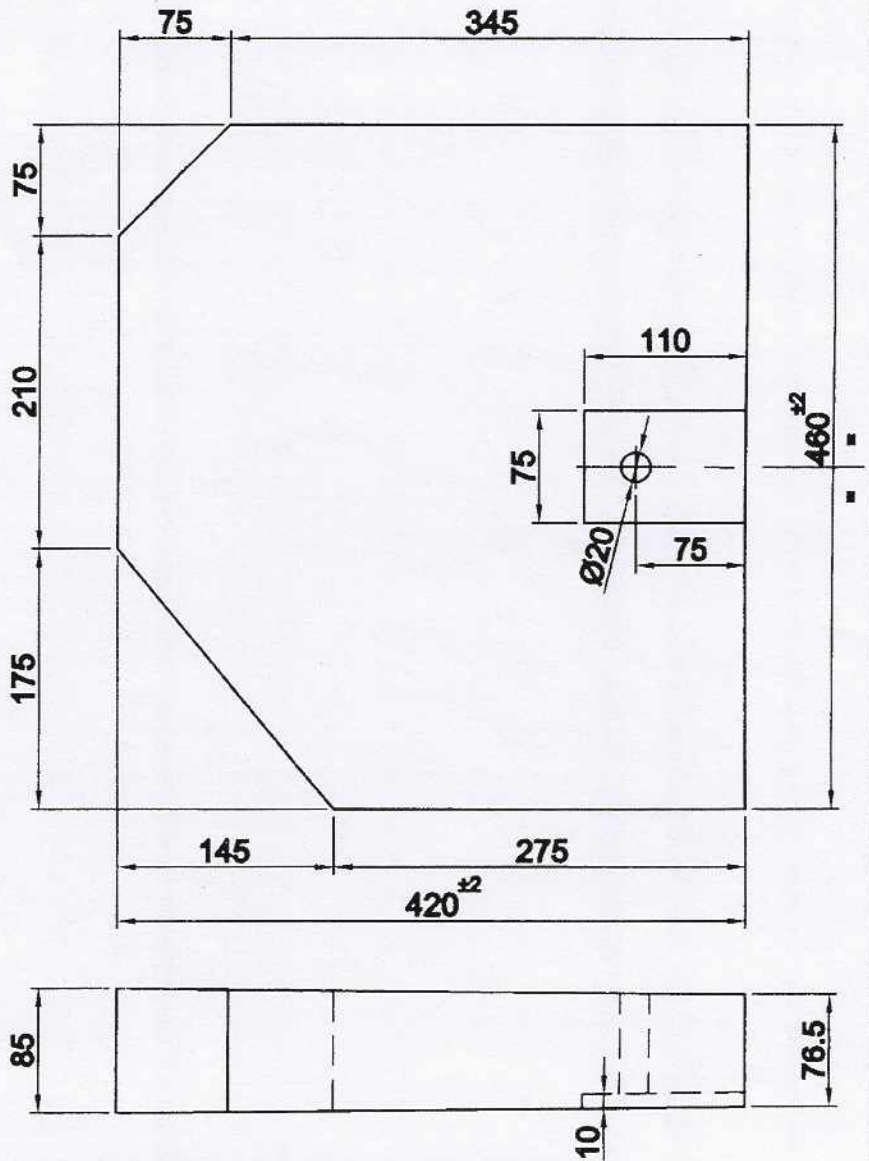

**NOTES:**

- 1) THE REFRACTORIES SHALL BE COMPACT, OF HOMOGENEOUS TEXTURE AND FREE FROM CRACKS, VOIDS AND OTHER FLAWS. THEY SHALL BE BURNT EVENLY THROUGHOUT AND SHALL HAVE SUFFICIENT MECHANICAL STRENGTH AND NO SOFT CORNERS.
- 2) ALL CORNERS TO BE MIN. 5mm RADII.

ITEM NO	DESCRIPTION	DRAWING NO	55%-60% AL <sub>2</sub> O <sub>3</sub>	320
			MATL CODE	UNIT WT
			MATL SPEC	QTY

EQPT: **ROTARY HEARTH FURNACE**



Bharat Heavy Electricals Ltd  
SEAMLESS STEEL TUBE PLANT  
TIRUCHIRAPALLI - 620014

DRN	NAME P. RAMAKRISHNAN	SIGNATURE	DATE 29.12.04
CHD	SSN.KUMAR	SIGNATURE	11/1/05
APPD	B.SHANMUGASUNDARAM	SIGNATURE	01/01/05

DEPT MPG	GRADE OF UNTOL DIM C/M/F	SCALE 1:5	WEIGHT (Kg) 35.5	REF TO ASSY DRG	ITEM NO
CODE				REF TO OLD DRG 358106 1/2-5	

TITLE  
**INNER WALL SUPPORTING  
BRICK**

CARD  
CODE  
U 01

DRAWING NO :  
**4-7-1101-01-06305**

REV  
**00**

CAUTION: THE INFORMATION ON THIS DOCUMENT IS THE PROPERTY OF BHARAT HEAVY ELECTRICALS LTD  
IT MUST NOT BE REPRODUCED DIRECTLY OR INDIRECTLY IN ANYWAY DETERMINAL TO INTEREST OF THE COMPANY

REV OR	DATE	ALTERED
		CHECKED
		APPROVED

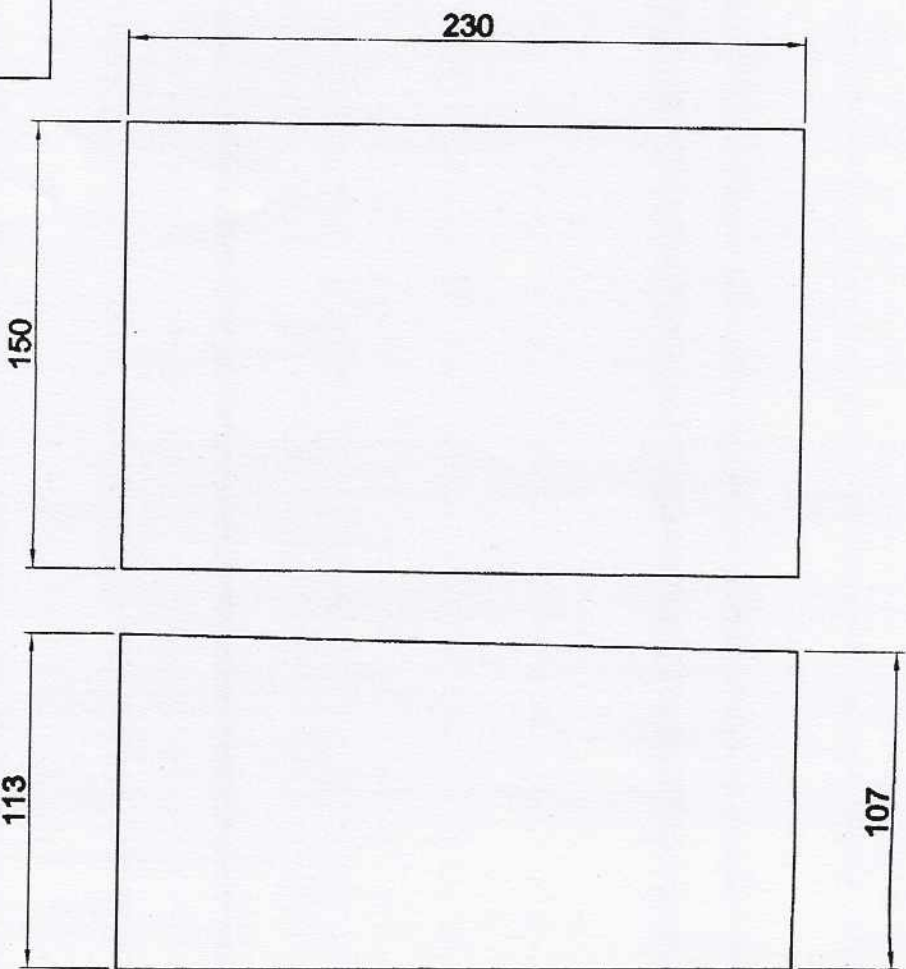

**NOTES:**

- 1) THE REFRACTORIES SHALL BE COMPACT, OF HOMOGENEOUS TEXTURE AND FREE FROM CRACKS, VOIDS AND OTHER FLAWS. THEY SHALL BE BURNT EVENLY THROUGHOUT AND SHALL HAVE SUFFICIENT MECHANICAL STRENGTH AND NO SOFT CORNERS.
- 2) ALL CORNERS TO BE MIN. 5mmRADI.

ITEM NO	DESCRIPTION	DRAWING NO	55%-60% AL <sub>2</sub> O <sub>3</sub>	220
			MATL CODE	UNIT WT
			MATL SPEC	QTY

EQPT: **ROTARY HEARTH FURNACE**

	Bharat Heavy Electricals Ltd SEAMLESS STEEL TUBE PLANT TIRUCHIRAPALLI - 620014		DRN	NAME P. RAMAKRISHNAN	SIGNATURE <i>P. Ramakrishnan</i>	DATE 29.12.04
			CHD	S.S.KUMAR	<i>S.S. Kumar</i>	1/1/05
			APPD	S.SHANMUGASUNDARAM	<i>S. Shanmugasundaram</i>	01/01/05

DEPT MPG	GRADE OF UNTOL. DIM C/M/F		SCALE 1:2.5	WEIGHT (Kg) 9.5	REF TO ASSY DRG	ITEM NO
CODE					REF TO OLD DRG 358106 1/2-12	

TITLE <b>INNER WALL SHAPE BRICK-I</b>	CARD CODE U 01	DRAWING NO : <b>4-7-1101-01-06312</b>	REV <b>00</b>
--	----------------------	--	------------------

ALL DIMENSIONS ARE IN MM

CAUTION: THE INFORMATION ON THIS DOCUMENT IS THE PROPERTY OF BHARAT HEAVY ELECTRICALS LTD  
IT MUST NOT BE USED DIRECTLY OR INDIRECTLY IN ANYWAY DETERMINANT TO INTEREST OF THE COMPANY

REV	DATE	ALTERED
01		CHECKED
		APPROVED

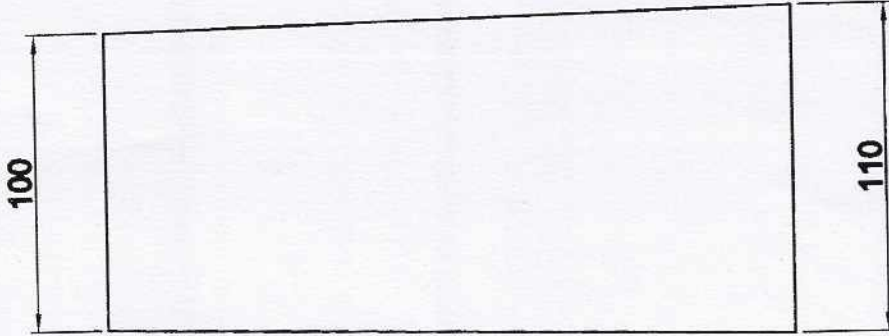
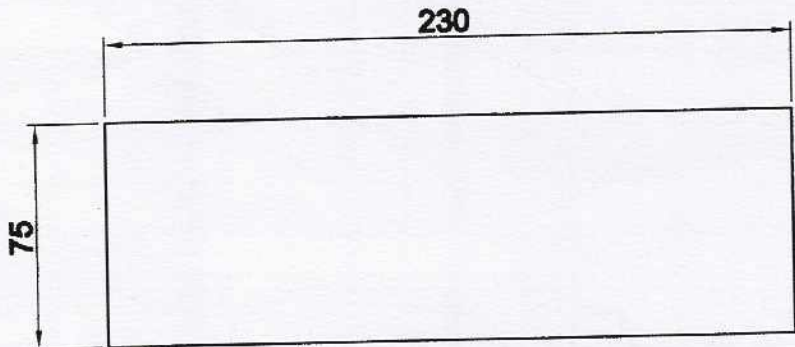

**NOTES:**

- 1) THE REFRACTORIES SHALL BE COMPACT, OF HOMOGENEOUS TEXTURE AND FREE FROM CRACKS, VOIDS AND OTHER FLAWS. THEY SHALL BE BURNT EVENLY THROUGHOUT AND SHALL HAVE SUFFICIENT MECHANICAL STRENGTH AND NO SOFT CORNERS.
- 2) ALL CORNERS TO BE MIN. 5mm RADII.

			55%-60% AL <sub>2</sub> O <sub>3</sub>	575
ITEM NO	DESCRIPTION	DRAWING NO	MATL CODE	UNIT-WT
			MATL SPEC	QTY
EQPT: <b>ROTARY HEARTH FURNACE</b>				
 Bharat Heavy Electricals Ltd SEAMLESS STEEL TUBE PLANT TIRUCHIRAPALLI - 620014		DRN	NAME <b>P. RAMAKRISHNAN</b>	SIGNATURE <i>P. Ramakrishnan</i>
		CHD	<b>SSN.KUMAR</b>	<i>SSN.Kumar</i>
		APPD	<b>S.SHANMUGASUNDARAM</b>	<i>S. Shanmugasundaram</i>
DEPT	MPG	GRADE OF UNTOL DIM	SCALE	WEIGHT (Kg)
CODE		C/M/F	1:2.5	4.5
TITLE		CARD CODE	REF TO ASSY DRG	ITEM NO
<b>INNER WALL SHAPE BRICK-II</b>		U 01	REF TO OLD DRG 358105 1/2-13	
		DRAWING NO :		REV
		<b>4-7-1101-01-06313</b>		<b>00</b>