

# REQUEST FOR QUOTATION

	<b>BHARAT HEAVY ELECTRICALS LIMITED</b> Electronics Division PB No. 2606, Mysore Road Bangalore - 560026 INDIA	RFQ NUMBER: LKK0000075  RFQ DATE : 25.APR.2015	Due Date <b>18.MAY.2015</b> Time: 13:00 HRS  VENUE : <b>NEW ENGG. BLDG</b>
MMI:PU:RF:003			

	(for all correspondence) Purchase Executive : Lokesh Kumar Khich Phone : 7760053776 Fax : E-mail: lkkhichi@bheledn.co.in
--	--

Please submit your lowest quotation subject to our terms and conditions attached for the material mentioned below. The quotation must be enclosed in a sealed envelope / Fax superscribed with RFQ no. and due date, should reach us on or before the due date by **13.00** hours IST and will be opened on the same day at **13.30** hours at the venue mentioned above. **PLEASE DROP THE OFFER IN THE BOX PROVIDED AT RECEPTION.**

1. TENDER/OFFER MUST BE SUBMITTED IN TWO PARTS: (1).TECHNO- COMMERCIAL BID (2).PRICE BID.
2. EARNEST MONEY DEPOSIT (EMD) OF RS.40,000 (FORTY THOUSANDS ONLY) IS MANDATORY AND TO BE SUBMITTED ALONGWITH THE TECHNO-COMMERCIAL BID. Please refer clause no. 10 of page no. 03 of CPD 2012.
3. VENDOR HAS TO CONFORM TO THE TECHNICAL SPECIFICATIONS (mentioned along with line item/ description) AS WELL AS THE ATTACHED DRAWING (Ref. 490-901 & 902). DEVIATIONS, IF ANY, TO BE BROUGHT OUT CLEARLY IN THE TECHNOCOMMERCIAL BID.
4. VENDOR IS ADVISED TO GO THROUGH THE GENERAL TERMS AND CONDITIONS, DOCUMENT CPD-2012 ENCLOSED WITH THIS RFQ.
5. VENDOR HAS TO CONFORM TO ALL THE CLAUSES LISTED IN THE COMMERCIAL TERMS (ANNEXURE B) of CPD 2012. DEVIATIONS, IF ANY, TO BE HIGHLIGHTED AND BROUGHT OUT CLEARLY IN THE TECHNICAL BID.
6. DELIVERY REQUIRED: 06 WEEKS FROM THE DATE OF PO.
7. TERMS OF PAYMENT: 80% BASIC + TAXES WITH 45 DAYS CREDIT AFTER RECEIPT OF MATERIAL, 10% AFTER COMMISSIONING AND 10% AGAINST SUBMISSION OF PERFORMANCE BANK GURANTEE (PBG) OR AFTER WARRANTY PERIOD.
8. QUOTATION SHOULD BE VALID FOR 90 DAYS FROM DUE DATE.
9. WARRANTY: 12 MONTHS FROM THE DATE OF COMMISSIONING OR 18 MONTHS FROM THE DATE OF INVOICE.
10. ADVANCE PAYMENT: QUATATION WITH #ADVANCE PAYMENT# SHALL BE LIABLE FOR REJECTION. CLAUSE No. 7 OF CPD 2012 TO BE IGNORED.

SI No.	Description	Qty	Unit	Delivery qty	Delivery Date
1	Stool with SS round plate with MS frame  Stool with SS round plate with MS frame. Dimension:Top sheet Dia-11"+0.5" Height-18"+0.5". Bottom Dia-12"+0.5". 4 nos. 1/2" pipe frame & leg fabricated with screw to SS round top and spray painted.  NOTE:Fabrication of stool complete in all respect will be as per drawing enclosed.	460	NO	460	28.MAY.2015
2	SS Dining Table 4 seater  SS Dining Table 4 seater, Made out of SS 202, 16gauge top, MS 32 Sq mm Pipe & angle for frame with spray painted. Dimension:Length-90"+0.5", Breadth-21"+0.5", Height-30"+0.5".  NOTE:Fabrication of SS Dining table complete in all respect will be as per drawing enclosed.	115	NO	115	28.MAY.2015

Total Number of Items - 2

Please note that the tender will be opened in the presence of the bidders or his authorised representatives (maximum two per organisation) who choose to be present with authorisation letters. Refer annexure for the terms and conditions.

Preference will be given to vendors who accepts our standard payment terms i.e.100% payment - 30 days after receipt of material at our works subject to acceptance.

For and On behalf of BHEL.

Page 1 OF 2

## REQUEST FOR QUOTATION

	<b>BHARAT HEAVY ELECTRICALS LIMITED</b> Electronics Division PB No. 2606, Mysore Road Bangalore - 560026 INDIA	RFQ NUMBER: LKK0000075  RFQ DATE : 25.APR.2015	<b>Due Date</b> <b>18.MAY.2015</b> <b>Time: 13:00 HRS</b>  VENUE : <b>NEW ENGG. BLDG</b>
MMI:PU:RF:003		(for all correspondence) Purchase Executive : Lokesh Kumar Khich Phone : 7760053776 Fax : E-mail: lkkhichi@bheledn.co.in	
Please submit your lowest quotation subject to our terms and conditions attached for the material mentioned below. The quotation must be enclosed in a sealed envelope / Fax superscribed with RFQ no.and due date, should reach us on or before the due date by <b>13.00</b> hours IST and will be opened on the same day at <b>13.30</b> hours at the venue mentioned above. <b>PLEASE DROP THE OFFER IN THE BOX PROVIDED AT RECEPTION.</b>			
Please specify Terms of delivery, Excise duty, sales tax, Ex-BHEL, Ex-works surcharge, Insurance,P&F, Freight and other taxes very clearly . For evaluation,exchange rate(TT selling rate of SBI) as on scheduled date of tender opening (Part-I bid incase of two part bid) shall be considered. The offers of the bidders who are on the banned list as also the offer of the bidders, who engage the services of the banned firms, shall be rejected.The list of banned firms is available on BHEL web site <a href="http://www.bhel.com">www.bhel.com</a>			
i). This is only RFQ not an order. ii). In all correspondence quote RFQ No. & due date. iii). In Quotation BHEL material code / RFQ Sl. No. should be mentioned clearly. iv). Quotation Envelope / Fax not superscribed with RFQ No.and due date is liable for rejection. v). Quotation should remain valid for a minimum peiod of 90 days from due date. vi). In case of non-receipt of Quotation or regret letter for 3 consecutive RFQs you are liable to be removed from our vendors list. vii). All Prices should be written in words and numbers. viii). Excise Chapter Heading should be mentioned for all items where VAT is applicable .			

For and On behalf of BHEL.

SS Dining Table

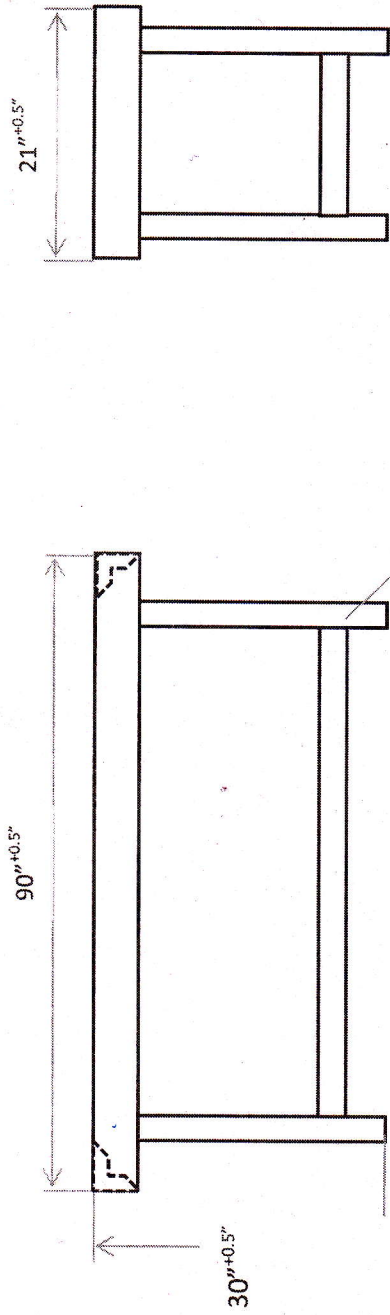

MS 32 Sq mm Pipe with spray painted

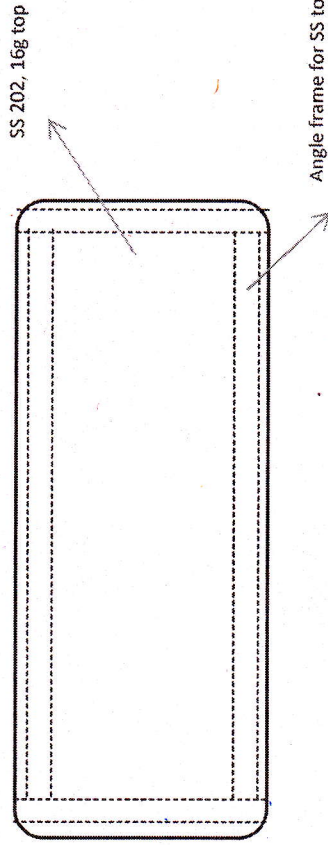

Angle frame for SS top with spray painted & 20mm Teak Wood/Beach Wood/Rubber wood to be used for top frame

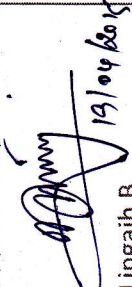

Prepared On: 19-04-15	Approved By
Prepared By  Karthik R	 Lingath B 19/04/2015

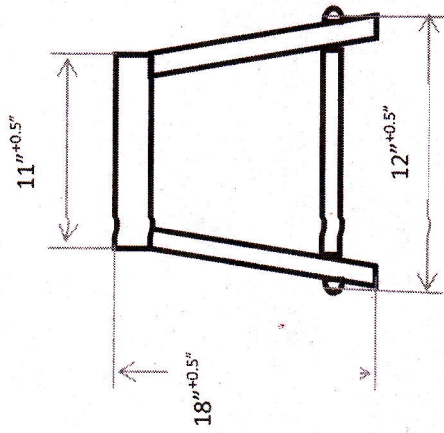
DRAWING No.	490-001
TITLE	SS DINING TABLE
PROJECTION	
SCALE	NTS

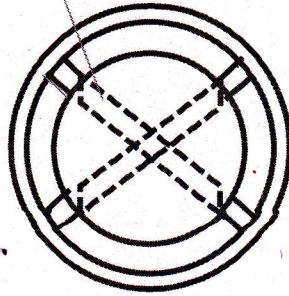

4 Nos. 1/2" pipe frame & leg fabricated with screw  
to SS round top and spray painted



Prepared On: 19-04-15	Approved By
Prepared By  Karthik R	 Lingaih B

DRAWING No.	490-002
TITLE	SS Stool
PROJECTION	
SCALE	NTS



**Bharat Heavy Electricals Ltd.,**  
(A Government of India undertaking)  
**Electronics Division**  
PB No.2606, Mysore Road, Bangalore-560026,India

**General Terms & Conditions for Supply of CAPITAL ITEMS**  
**(Imported &Indigenous)**  
**Doc Ref: CPD-2012**

**I. Enquiry / Request For Quotation (RFQ):**

- (a) Any Purchase Order resulting from this enquiry shall be governed by **these general terms and conditions listed below and special terms and conditions, if any, along with this enquiry** of Bharat Heavy Electricals Limited, Electronics Division, Bangalore-560026 (**hereinafter referred to as BHEL EDN**).
- (b) Any of the terms and conditions not acceptable to vendor, shall be explicitly mentioned in the quotation. Otherwise, it will be treated as that all terms and conditions of this enquiry are acceptable.
- (c) If counter terms and conditions are offered by vendor, BHEL EDN shall not be governed by such terms and conditions, unless it is agreed and incorporated in the Purchase Order of BHEL EDN.
- (d) Any deviation to the terms and conditions not mentioned in the quotation by vendor in response to this enquiry will not be considered, if put forth subsequently or after issue of order, unless clarification is sought for by BHEL EDN and agreed upon in the Purchase Order of BHEL EDN.
- (e) BHEL EDN reserves the right to adopt Reverse Auction for the enquiry sent, at its discretion.
- (f) BHEL EDN shall be at liberty to cancel the tender at any time, before ordering, without assigning any reason.
- (g) Any specific terms and conditions to be complied will be mentioned in RFQ.

**II. General Terms and conditions:**

1. **TWO PARTS BID:** Quotation shall be submitted in two parts bid i.e.

(a) **Techno-commercial i.e., Un-priced Bid (in one sealed envelope):**

Techno-commercial bid shall be submitted with complete description of the equipment, specification compliances to the enquired specification and all the commercial terms & conditions indicated in the **COMMERCIAL TERMS (ANNEXURE-A / ANNEXURE-B)**. Any other enclosure, which the vendor wishes to submit like product catalogue, technical literature etc., may also be submitted in a sealed envelope super scribed clearly as "**TECHNO-COMMERCIAL BID**" with **RFQ No. and DUE DATE**. An un-priced copy of price bid (without price) shall also be enclosed with the techno-commercial bid for evaluation of commercial terms. **The vendor shall not give the price in the technical bid. EMD Payment if applicable as mentioned in RFQ shall be enclosed along with the Techno-commercial Bid.**

Confirmation to BHEL specifications shall be indicated by the vendor in the respective columns provided in the purchase specification wherever applicable. Deviations to the specification / item description, if any shall be brought out clearly indicating "DEVIATION TO BHEL SPECIFICATION" without fail as a part of technical offer.

Compliance to Pre-qualification criteria (if applicable) shall also be enclosed with the Techno-commercial bid.

Manufacturer's name, their trade mark and brand, part number, alternate material to the one asked in enquiry, if any, should be mentioned in quotation and illustrative leaflets giving technical particulars etc. are to be attached to facilitate consideration and technical evaluation of the quotation.

BHEL EDN material code number (as in enquiry) shall be indicated for each item quoted.

**(b) Price Bid (in one sealed envelope):**

Price bid should contain basic unit prices, discount if any, applicable taxes & duties, packing & forwarding charges (if applicable), Freight & insurances (if applicable) FOB charge (if applicable) etc., in a sealed envelope super scribed clearly as "**PRICE BID**" with **RFQ No. and DUE DATE**. Installation, commissioning, start-up and training charges (if any) shall also be indicated in the price bid.

It is preferred to indicate the rates in both figures and words. In such case, if there is difference / discrepancy between the rates in figures and words, the **least of the two** rates will be considered.

**(c) Tender Offer (above two envelopes inside another sealed envelope):**

Both these sealed envelopes [(a) Techno-commercial i.e., un-priced Bid and (b) Price Bids] shall be kept in a single sealed envelope and super scribed clearly with **RFQ No. and DUE DATE**.

2. The above sealed envelope (Tender) shall reach our office on or before the due date by **13:00 hrs.** Quotations are to be dropped in the tender box marked for the **OPENING ON** respective days i.e., **MONDAY (BOX NO.4)/ WEDNESDAY (BOX NO.6)/ FRIDAY (BOX NO.8)** kept at **BHEL-EDN's Reception area of our works with caption "CE, SC & PV, DEFENCE"**. **Quotations also can be dispatched by Couriers / Registered post / FAX / e-mail to the Purchase Executive indicated in the RFQ at the risk of vendor / bidder.**

Quotation through courier / register post / fax / email when addressed to the specific fax number and email address given in the enquiry, to be sent well in advance to enable BHEL EDN purchase personnel to drop in the tender box before the scheduled opening date and time. **Vendor is fully responsible for lack of secrecy on information of such quotations.** Vendor shall confirm with the concerned purchase executive after sending the offer regarding such delivery mode to ensure participation. BHEL EDN is not responsible for any delay in receipt of quotation sent by vendor through post/fax/email.

Late Tenders i.e., Tenders received after due date will be rejected.

3. The rate quoted against each item shall be in units stated in the enquiry. Where quotation is in terms of unit other than that in enquiry, relationship between the two units must be furnished in the quotation.
4. As far as possible, the quotations shall be free from corrections / overwriting. Corrections / overwriting, if any should be signed by authorized person with the company seal. Any typographical errors, totaling mistakes, currency mistakes, multiplication mistakes, summary mistakes observed in your priced bids, BHEL may consider whichever is beneficial to BHEL for evaluation. Vendor shall doubly ensure that the quote is correct and complete. The corrections / overwriting if any shall be signed with the seal.
5. Quotations are to be duly signed. Unsigned bids/offers are liable for rejection.
6. Tenders will be opened at **13:30 hrs.** and the venue is NEB, 2<sup>nd</sup> floor, MM conference hall. All the tenderers or their authorized representatives (with authorization letter from their principals) may witness opening of techno-commercial bid on the due date.
7. After evaluation of techno-commercial bids, price bids of only those which are technically & commercially accepted, will be opened on a subsequent date, which will be intimated to the concerned in advance for witnessing of price bid opening.
8. The quantity in each item to be purchased may vary from quantity enquired according to the actual requirement at the time of placing the purchase order. Quantity discount, if any, should be mentioned in the quotation.
9. BIDDERS (for indigenous purchase) shall indicate clearly Excise duty, Education Cess, Sales Tax/VAT, Octroi, Exit/Entry tax, Service Tax as applicable for the quoted items. In the absence of clarity of these, any claim at a later date will not be entertained. Any changes in Taxes and duties after award of the contract will not be considered except such are those, which are imposed by Govt., notification within the contractual delivery after placement of PO. Seeking price amendments for change in Excise duty due to crossing of turnover limits will not be considered under any circumstances.

**10. EARNEST MONEY DEPOSIT (EMD):**

EMD if applicable is mandatory and will be indicated in the RFQ. EMD shall be sent either by Pay Order or Demand Draft in favour of M/s Bharat Heavy Electricals Ltd, Electronics Division, Bangalore only. In case of foreign bidders, e-payment may also be made as EMD, details shall be obtained from purchase executive

EMD by the Tenderer will be forfeited as per Tender Documents if, the successful bidder/vendor refuses to honour the Order after award of the same on him and/or withdraws his bid and /or unilaterally changes the offer and/or any of its terms & conditions within the validity period. EMD of unsuccessful Tenderers shall be returned on acceptance of award /LOI/PO on successful Tenderer. The EMD of successful bidder shall be returned only after submission of Contract Execution Bank Guarantee (CEBG).

EMD will not carry any interest.

EMD will be waived in the following cases on submission of required documents by:

- a) Central / State - PSUs / Government departments
- b) Valid Micro and Small Enterprises under MSME. If claiming exemption under Micro or Small enterprise, submit the notarized/attested copy of your certificate along-with the original auditor's certificate stating the investment in your plant and machinery as on 31.03.2013 as per the format in Annexure-I

**11. DUN & BRADSTREET REPORT (for Foreign purchase):**

In case of foreign vendors, BHEL reserves the right to verify the Dun & Bradstreet report during techno-commercial scrutiny. Please mention your DUNS Number in the techno-commercial bid.

**12. Payment of Agency Commission to Indian Agent (for Foreign purchase):**

i. BHEL shall deal directly with foreign vendors, wherever required, for procurement of goods. However, if the foreign principal desires to avail of the services of an Indian agent, then the foreign principal should ensure compliance to regulatory guidelines - which require mandatory submission of an Agency Agreement.

ii. It shall be incumbent on the Indian agent and the foreign principal to adhere to the relevant guidelines of Government of India, issued from time to time.

iii. The Agency Agreement should specify the precise relationship between the foreign OEM / foreign principal and their Indian agent and their mutual interest in the business. All services to be rendered by agent/ associate, whether of general nature or in relation to the particular contract, must be clearly stated by the foreign supplier/ Indian agent. Any payment, which the agent or associate receives in India or abroad from the OEM, whether as commission or as a general retainer fee should be brought on record in the Agreement and be made explicit in order to ensure compliance to laws of the country.

iv. Any agency commission to be paid by BHEL to the Indian agent shall be in Indian currency only.

v. Tax deduction at source is applicable to the agency commission paid to the Indian agent as per the prevailing rules.

vi. In the absence of any agency agreement, BHEL shall not deal with any Indian agent (authorized representatives / associate / consultant, or by whatever name called) and shall deal directly with the foreign principal only for all correspondence and business purposes.

vii. The "Guidelines for Indian Agents of Foreign Suppliers" enclosed at annexure –'A' shall apply in all such cases.

viii. The supply and execution of the Purchase Order (including indigenous supplies/ service) shall be in the scope of the OEM/ foreign principal. The OEM/ foreign principal should submit their offer inclusive of all indigenous supplies/ services and evaluation will be based on 'total cost to BHEL'. In case OEM/ foreign principal recommends placement of order(s) towards indigenous portion of supplies/ services on Indian supplier(s)/ agent on their behalf, the credentials/ capacity/ capability of the Indian supplier(s)/ agent to make the supplies/ services shall be checked by BHEL as per the extant guidelines of Supplier Evaluation, Approval & Review Procedure (SEARP), before opening of price bids. In this regard, details may be checked as per Annexure-H. It will be the responsibility of the OEM/ foreign principal to get acquainted with the evaluation requirements of Indian supplier/ agent as per SEARP available on [www.bhel.com](http://www.bhel.com).

The responsibility for successful execution of the contract (including indigenous supplies/ services) lies with the OEM/ foreign principal. All bank guarantees to this effect shall be in the scope of the OEM/ foreign principal.

**13. VALUE FOR ERECTION & COMMISSIONING AT BHEL:**

Erection & Commissioning (E&C) value will include services to be rendered at BHEL like erection, commissioning, job proving, performance tests, and training to operators etc.

The estimated percentage of E&C value shall be 10% or as specified in the RFQ.

E&C value should be quoted separately by bidders. Only in case where quoted value is less than the value (in %) specified in the NIT or separate E&C values are not mentioned in the offer, value for E&C portion shall be deemed to be considered as the value indicated in NIT & accordingly supply value will be adjusted from that quoted value and balance will be released as E&C payment as per clause 16.

**14. TOTAL COST TO BHEL:**

The bidders shall quote charges for 'Supply' and 'Erection & Commissioning' separately.

Purchase order will be placed on the lowest quotation (L1) only among the technically & commercially accepted quotations. Lowest quotation (L1) is determined on the basis of the total cost to BHEL.

The evaluation of tender shall be on the basis of total cost to BHEL including supply and Erection and Commissioning. For evaluation Exchange rate (TT selling rate of SBI) ruling on the date of Tender opening (Techno-commercial / un-priced Bid) will be considered for converting foreign currency to Indian currency. Loading factors for deviations to BHEL commercial terms & conditions will be considered.

**15. FIRM PRICE:** Rates quoted should be firm from the date of P.O., to the completion of supply and no enhancement in the rates and changes in the techno-commercial terms will be allowed once the quotation is accepted and order is placed.

If Erection & Commissioning is in vendor's scope, then the price shall remain FIRM till commissioning & handing over of the complete system.

**16. TERMS OF PAYMENT:****(a) FOR FOREIGN PURCHASE:**

Payment will be made against "**SIGHT DRAFT**" on presentation of documents to our bankers. Subject to loading factors as per **Clause 32 (Ai)**, BHEL may agree for the payment through LC at its discretion. For LC payment bank charges within India will be borne by BHEL and outside India will be to vendor's account.

The payment terms are as follows:

~~(i) 90% against complete dispatch documents i.e. AWB / BOL, Invoice, Packing list, Warranty certificate, Nil shortage certificate, Certificate of country of origin etc., & balance 10 % after completion of commissioning or on submission of Performance Bank Guarantee (PBG).~~

(ii) 80% against complete dispatch documents i.e. AWB / BOL, Invoice, Packing list, Warranty certificate, Nil shortage certificate, Certificate of country of origin etc., 10% after completion of commissioning & balance 10 % on submission of Performance Bank Guarantee (PBG) (where both commissioning & PBG are applicable).

Note: If PBG could not be submitted, vendors can also accept for the final 10% payment, payable after the warranty period + 6 months of claim period against supplementary invoice subject to the completion of commissioning (if applicable). In such cases loading for PBG is not applicable.

If payment terms as mentioned by BHEL are not agreed by bidder, such bidder have to submit Bank Guarantee at the time of payment / opening of LC in the prescribed Format of the amount, exceeding 80% of the PO value, valid till issue of E&C Certificate for the equipment.

#### **Payment through L/C:**

Where the payments are through L/C (L/C opening charges are to be loaded), payment of Supply value shall be 80% on dispatch and 20% on issue of E&C Certificate. Payment of E&C value shall be made against E&C certificate issued by BHEL. E&C certificate shall be issued on satisfactory completion of erection, commissioning, job proving, performance tests, and training to operators etc. as envisaged in PO. The L/C shall be opened by BHEL as per following:

- (i) Within 30 Days of receipt of acceptable CEBG, an irrevocable unconfirmed L/C will be opened for 30% of the payment towards supply, due on shipment i.e. 24% of the Supply value of PO (30% of 80%).

Not earlier than 60 days before the shipment date, the value of this irrevocable unconfirmed L/C would be enhanced from 24 % to 80% of the Supply value of PO.

The above L/C can be negotiated after the Shipment against submission of B/L or AWB and such other documents as mentioned in the PO. The above L/C will be valid for a period extending 21 days beyond the shipment date for negotiation of documents.

- (ii) 15 days prior to the scheduled & confirmed arrival of the technicians of supplier with their names, an irrevocable unconfirmed L/C will be opened for a value equal to 20% of the Supply value of PO plus 100% of the E&C value of PO. The validity of L/C would be sufficient to cover the period required for the completion of E&C plus 21 days as negotiation period.

This L/C can be negotiated after: (a) Completion of E&C of the equipment in BHEL and against E&C certificate issued by BHEL and (b) Submission of Performance Bank Guarantee (PBG) by Supplier in the prescribed Format valid for 30 days beyond the warranty period, from one of the Consortium Banks of BHEL or from a reputed Bank and confirmed by Consortium Bank of BHEL for 10% of total PO Value. The PBG confirmation charges shall be borne by vendor.

Under all circumstances, CEBG will be kept valid till the PBG becomes operational.

#### **(b) FOR INDIGENOUS PURCHASE:**

- ~~(i) 90% basic payment + 100% taxes & duties shall be within 45 days & balance 10 % after completion of commissioning or on submission of Performance Bank Guarantee (PBG).~~

- (ii) 80% payment of Supply value shall be made within 45 days from the date of receipt of material at BHEL. Balance 20% of Supply value plus 100% of the E&C portion of PO value will be paid against E&C certificate issued by BHEL and submission of Performance Bank Guarantee (PBG) valid for 30 days beyond the warranty period by Supplier from any of the

**Consortium Banks of BHEL for 10% of total PO Value in the prescribed Format. The PBG confirmation charges shall be borne by vendor.**

Note: If PBG could not be submitted, vendors can also accept for the final 10% payment, payable after the warranty period + 6 months of claim period against supplementary invoice subject to the completion of commissioning (if applicable). In such cases loading for PBG is not applicable.

If payment terms as mentioned by BHEL are not agreed by bidder, such bidder have to submit Bank Guarantee at the time of payment in the prescribed Format of the amount, exceeding 80% of the PO value, valid till issue of E&C Certificate for the equipment.

**17. ADVANCE PAYMENT: Quotations with “Advance payment” without fully securing with equal value of BG shall be liable for rejection.**

**18. PENALTY: Failure to supply/completion of E&C within the delivery time as per purchase order will make the vendor liable to an unconditional **penalty of 0.5 % (half percent) per week at the basic price of the goods/E&C for the undelivered quantity, subject to a maximum of 10%.****

If pre-shipment inspection is involved, date of issue of pre-shipment call by the vendor along with test certificates / test reports / certificate of conformance / calibration reports as proof of completion will be treated as date of dispatch for the purpose of penalty calculation. In the absence of reports stated above, actual date of inspection will be considered as date of dispatch for penalty calculation.

Date of receipt / Date of dispatch / Date of LR / Date of Airway bill / Date of pre-shipment inspection call with relevant documents as stated above, whichever is applicable as mentioned in PO shall be considered for determination of actual delivery date for the purpose of penalty calculation. BHEL is not liable for delayed OA for opening LC or corrections/amendment to LC asked after opening of LC.

**19. Contract Execution Bank Guarantee (CEBG):**

**CEBG shall be required for all POs where value (Supply + E&C) of each P.O. is more than Rs. 20 lakhs. CEBG should be submitted as per the format in Annexure-D.**

The successful vendor shall have to furnish a Contract Execution Bank Guarantee (CEBG) for 10% of the Total PO value in the prescribed format within 30 days from the date of P.O. but before L/C opening. CEBG shall be from one of the Consortium Banks of BHEL or from a reputed Bank and confirmed by any Consortium Bank of BHEL. All bank charges on account of issuance and confirmation of CEBG whether incurred in India or outside India will have to be borne by the vendor.

CEBG shall be kept valid until 30 days after the date of E&C Certificate, which will be issued on completion of Erection & Commissioning of equipment which includes erection, commissioning, job proving, performance tests, and training to operators etc. as prescribed in PO.

If the supplier fails to submit the CEBG even within 60 days from the date of PO, BHEL reserves the right to cancel PO & forfeit the EMD given by the supplier. In addition, in such case, action will be initiated in line with extant guidelines for Suspension of Business dealings with Suppliers.

**20. PBG:** Performance Bank Guarantee (PBG) (If applicable): The vendor shall submit a PBG worth 10% of basic equipment value in the form and substance acceptable to BHEL from any of the Banks indicated in **ANNEXURE-G**. Such PBG shall be as per the format provided at **ANNEXURE - E/ ANNEXURE - F** and drawn on a non-judicial stamp paper of value Rs.100/-.

PBG shall be valid for 30 days beyond the warranty period of 12 months from the date of commissioning or 18 months from the date of dispatch whichever is earlier or as mentioned in the RFQ. The PBG shall also have 6 months claim period from the date of expiry of such validity of bank guarantee.

**The Bank Guarantee shall be submitted directly to the concerned Purchase Executive by the issuing Bank with their forwarding letter.** BHEL will verify independently with the bank to establish the authenticity.

**21. WARRANTY:** Goods dispatched shall have warranty period of 18 months from the date of dispatch or 12 months from the date of commissioning whichever is earlier or as mentioned in the RFQ.

## **22. TERMS OF DELIVERY:**

### **(a) FOR IMPORTED PURCHASE:**

Price offered shall be for goods packed and delivered F.O.B. (named international Airport / sea port) including packing, forwarding, Handling, Ancillary charges like processing of Sight Draft, Letter of credit (L/C) if applicable, negotiation of bank documents, Export declaration, Certificate of origin etc.

Packing shall be Road / Rail / Air / Sea worthy, best suitable for transshipment and to take care of transit damages. If containerized, no. of containers & size of container shall be mentioned. Packing weight (gross & nett) Packing dimensions shall be given prior to shipment to ascertain whether the consignment can be carried on standard cargo in contract or as ODC.

Wooden packing material for all the foreign consignments should be treated as per ISPM-15 & Fumigation / Phytosanitary certificate to be submitted to the freight forwarders/ BHEL along with the invoice, AWB, packing list etc.

Vendors shall indicate the name of International Airport/ Seaport. The consignment shall be handed over to BHEL approved freight forwarded as mentioned in PO.

Note: Name of International Airport has to be selected from any one of the airports indicated in the table provided in ANNEXURE –C.

### **(b) FOR INDIGENOUS PURCHASE:**

Equipment shall be delivered on Ex-EDN/ Ex-ESD BHEL, Bangalore basis, inclusive of freight, packing, insurance & forwarding charges.

Packing shall be Road / Rail / Air / Sea worthy, best suitable for transshipment and to take care of transit damages.

Smaller consignments can be dispatched through Courier services/ RPP with the prior approval of the purchasing Executive.

**23. DELIVERY REQUIREMENT:** The bidders should quote their earliest schedule for Supply and E&C against the schedule indicated in the RFQ. BHEL, however, reserves the right to accept an offer not meeting the RFQ schedule.

In the quotation, earliest firm delivery (number of days or weeks) by which material will be dispatched from the date of Purchase order must be indicated. It is recommended to avoid Quotations with delivery term such as `ex-stock`, `subject to prior sale`, or `delivery at the earliest`. Date of BHEL PO is the reference for all purposes.

**24. VALIDITY:** Quotation should remain valid for a period of **90 days** from the date of technical bid opening. Offer with Non-conformance is liable for rejection.

**25. POST-ORDER REQUISITES:**

(a) Vendor shall give an Order Acknowledgement indicating the delivery date within one week of receipt of PO.

(b) Pre-shipment inspection at vendor's works, if required, will be carried out by BHEL. Required assistance will have to be provided by the vendor at the time of pre-shipment inspection.

(c) Test certificates, Calibration certificates and warranty certificates as stipulated at the time of ordering shall be furnished.

(d) Items shall be dispatched by Air/Road/Rail/Sea worthy packing. Any damage and later rejection, due to poor / improper packing shall be to vendor's account.

(e) Any damage/rejection should be made good or replaced immediately without any extra cost to BHEL such as freight, duties, taxes etc. The liability is restricted to the value of the order.

(f) Wherever commissioning is involved, it shall be carried out by the vendor's qualified engineers. Scope of work includes installation, commissioning and start-up trials till satisfactory performance level is reached as certified by BHEL.

(g) BHEL will not be responsible for any loss, damage or injuries to vendor's personnel sustained during installation / commissioning / start-up trials. Vendor shall ensure compliance with all statutory requisites as laid down by local bodies, state & Central Government. Vendor shall indemnify BHEL for all damages/ losses to various personnel during their presence in BHEL's premises for whatever purpose. The following shall be ensured by the vendor:

a) Vendor/contractor shall ensure that the vendor/contractor's workmen always follow safe work procedure during erecting/ commissioning activities.

b) Vendor/contractor shall ensure that the vendor/contractor's workmen wear safety PPEs (shoes, helmets, safety belt etc.) while on erecting/ commissioning work and similar works.

c) Vendor/contractor shall ensure adequate supervision of the activity by his/her supervisor/engineer during the erecting/ commissioning activities.

d) Vendor/contractor shall ensure that vendor/contractor's workmen meet legal requirement such as ESI/Workmen Compensation Act/Accident/medical insurance etc.

e) Vendor/contractor shall take work permit before commencement of the non-routine works of this nature.

f) Undertaking that vendor/contractor will adhere to necessary legal/safety requirements and BHEL shall be kept indemnified against any untoward events taking place during the course of work.

(h) Suitable markings & damage control indicating devices shall be provided where applicable.

26. Equipment shall comply with the standard requirements of ISO 14001 & OHSAS 18001.

27. **RISK PURCHASE:** The purchaser at his discretion may also make purchase of the materials **NOT** supplied in time at the **RISK & COST** of the supplier. In this event, it will be obligatory on the part of the supplier who fails to supply the goods in time to make good to BHEL any loss due to such risk purchase

**28. GENERAL TERMS AND CONDITIONS GOVERNING REVERSE AUCTION (RA):**

(a) Against this enquiry for the subject item/system with detailed scope of supply as per enquiry specifications, BHEL may resort to "REVERSE AUCTION PROCEDURE" i.e., ON LINE BIDDING ON INTERNET. • For the proposed RA, technically and commercially acceptable bidders only shall be eligible to participate.

(b) In case of RA, BHEL will engage the services of a service provider for conduct of the RA who will provide all necessary training and assistance to the bidders before commencement of on line bidding on internet.

(c) Business rules governing the RA will be communicated to the bidders through service provider for compliance.

(d) Vendors have to fax the Compliance form in the prescribed format (provided by Service provider) before start of RA. Without the compliance, the vendor will not be eligible to participate in the event.

(e) BHEL will provide a sample calculation sheet (in EXCEL format) which would help the bidders to arrive at "Net Cash outflow to BHEL" considering various price / cost elements like Packing & forwarding charges, Taxes and Duties, Freight charges, Insurance, Service Tax for Services and loading factors (for non-compliance to BHEL standard Commercial terms & conditions) etc. for each of the bidders to enable them to arrive at "Net Cash outflow to BHEL ( Total Cost to BHEL)" which is the amount the bidder would be bidding during the RA.

(f) RA will be conducted on scheduled date & time and at the end of event, the lowest bidder value will be known on the network.

(g) The lowest bidder has to Fax the duly signed "Price Break-up" in prescribed format as provided on case-to-case basis to BHEL through Service provider within 24 hours of Auction without fail.

(h) Any variation between the on-line bid value and the signed document will be considered as sabotaging the tender process and will invite disqualification of vendor to conduct further business with BHEL, as per the prevailing procedure.

**29. REGRET LETTER:** In case any vendor is unable to quote, vendor shall send a regret letter without fail. In case of non-receipt of quotations or regret letters for three consecutive enquiries, such vendor is liable to be removed from our vendor list.

**30.** Any dispute arising out of this, shall be referred to the sole arbitration of Head of Dept. Materials Management of group concerned, BHEL EDN or any other officer nominated by him and his award shall be final and binding on the parties. The venue of the arbitration in all cases shall be Bangalore.

**31.** Any legal suit in respect of this enquiry lies in the court of Jurisdiction of Bangalore (India) only.

**32. LOADING FACTORS:**

Loading factors as detailed below will be added to the quoted price (basic) to evaluate the lowest quote for non compliance of BHEL standard commercial terms.

**A: Bank Guarantee and Loading against non-acceptance of BHEL's Payment Terms:**

If payments terms as mentioned by BHEL are not agreed by bidder, such bidder have to submit Bank Guarantee at the time of payment / opening of LC in the prescribed Format of the amount, exceeding 80% of the PO value, valid till issue of E&C Certificate for the equipment. However, in no case, payment against dispatch shall exceed 90% of the PO Value.

Additionally, for any deviation sought including as mentioned above, in Payment Terms by bidder w.r.t. tender conditions, following loading shall be followed:

- (a) Benchmark Prime Lending Rate (BPLR) of SBI as applicable on the scheduled date of tender opening + 2%, for the amount & period of relaxation sought by bidder.
- (b) On account of payment through LC, if insisted by bidder, Bank charges shall also be loaded for the deviation in (i) opening of LC by BHEL and (ii) period and amount of LC w.r.t. NIT norms, as per the prevailing bank rates.

**(i). For non compliance of standard Terms of payment (For Foreign Purchase Orders)**

Sl. No.	BHEL standard term	If you quote	Loading factor in % for non-compliance
1	<del>90% against "SIGHT DRAFT" + 10% against PBG (where PBG only is applicable)</del>	Payment through Letter of Credit (LC) with bank charges to respective accounts	(BPLR+2%) x Percentage quoted through LC
2	80% against "SIGHT DRAFT" + 10% after commissioning +10% against PBG (where both E&C and PBG are applicable)	Payment through Letter of Credit (LC) with bank charges to respective accounts	(BPLR+2%) x Percentage quoted through LC

**A(ii).For non compliance of standard Terms of payment (For Indigenous Purchase Orders)**

Sl. No.	BHEL standard term	If you quote	Loading factor in % for non-compliance
1	<del>90% basic payment + 100% taxes &amp; duties with 45 days credit + 10% against PBG (where PBG only is applicable)</del>	Payment through bank	(BPLR+2%) x percentage quoted through bank / proforma invoice
		Payment against proforma invoice	
		100% with 45 days credit & against submission of PBG	Nil
2	80% basic payment + 100% taxes & duties with 45 days credit + 10% after commissioning +10% against PBG (where both commissioning & PBG are applicable)	Payment through bank	(BPLR+2%) x percentage quoted through bank / proforma invoice
		Payment against proforma invoice	
		100% with 45 days credit after commissioning & submission of PBG	Nil

**B. For non compliance of Penalty clause for in 'SUPPLY' and 'E&C':**

For the purpose of penalty for delay E&C of the equipment the duration will be reckoned from the date of intimation by BHEL to vendor for readiness of site

Penalty on delay in 'Supply' and/or 'E&C' will be applicable to the delays attributed to vendor. Penalty will be considered separately for 'Supply' and 'E&C'.

The rate of penalty for delayed Supply shall be @ 0.5% per week of delay of total PO value (Supply + E&C) in supply subject to a maximum of 10% of total PO value (Supply + E&C).

The rate of penalty for delayed E&C shall be @ 0.5% per week of delay of total PO value (Supply + E&C) in E&C subject to a maximum of 10% of total PO value (Supply + E&C).

Maximum penalty for delay in Supply and E&C together shall be limited to 15% of total PO value (Supply + E&C).

In case PO includes more than one machine, the penalty shall be @ 0.5% per week of delay on total PO value (Supply + E&C) for the delayed machine.

In case any bidder is not accepting the above penalty for delayed Supply and/or E&C, the offer of bidder shall be loaded to the extent to which it is not agreed by the bidder.

Sl. No.	BHEL standard term	If you quote	Loading factor for non-compliance
1	The rate of penalty for delayed Supply shall be @ 0.5% per week of delay of total PO value (Supply + E&C) in supply subject to a maximum of 10% of total PO value (Supply + E&C).	Not agreed.	10%
		Other than the above.	10% - (minus) agreed max. %
2	The rate of penalty for delayed E&C shall be @ 0.5% per week of delay of total PO value (Supply + E&C) in E&C subject to a maximum of 10% of total PO value (Supply + E&C).	Not agreed.	10%
		Other than the above.	10% - (minus) agreed max. %

In case, any shortage is noticed viz-a-viz PO requirement in the main equipment / spares, such shortages shall be replenished by supplier on FOR destination basis without any cost implication to BHEL i.e. Custom Duty and freight charges etc. up to destination for such short supplies shall be borne by the supplier.

Supply period indicated by bidder should include reasonable time required for approval of drawings and other inputs from BHEL. In the Techno-Commercial Bid, the bidder shall submit milestones for various activities in co-relation with Supply and E&C period quoted by him.

**C. For non compliance of Performance Bank Guarantee (PBG) (If applicable:**

Sl. No.	BHEL standard term	If you quote	Loading factor for non-compliance
1	PBG for 10% of the basic material cost shall be furnished in the BHEL prescribed format.	Not agreed.	10 %
		Other than the above.	10% - (minus) agreed max. %

**D. For non conformance to delivery requirement indicated in the RFQ:**

Sl. No.	BHEL standard term	If you quote	Loading factor for non-compliance
1	Delivery requirement as indicated in the RFQ in number of weeks from the date of issue of PO	Not agreed for the stipulated delivery in the RFQ	0.5 % per week up to max., of 10% for the difference in delivery period

**E. For non compliance of Warranty:**

Sl. No.	BHEL standard term	If you quote	Loading factor for non-compliance
1	18 months from the date of dispatch or 12 months from the date of commissioning whichever is earlier or as indicated in the RFQ	Not agreed.	6%
		Less than 12 months or as indicated in the RFQ	0.5 % per month for the difference in period

**F (i) For Non- agreement on delivery at BHEL-EDN/ESD (For Foreign Purchase Orders):**

Sl. No.	BHEL standard term	If you quote	Loading factor for non-compliance
1	FOB / CIF to nearest international Airport/Seaport	Not agreed for the standard term of delivery	10 %

**F(ii) For Non- agreement on delivery at BHEL-EDN/ESD (For Indigenous Purchase Orders):**

Sl. No.	BHEL standard term	If you quote	Loading factor for non-compliance
1	Ex- EDN or ESD / BHEL, Bangalore (Free delivery to BHEL Bangalore including freight, packing & forwarding charges)	Not agreed for the standard term of delivery	10 %

**ANNEXURE-A**

**COMMERCIAL TERMS (to be enclosed with TECHNO-COMMERCIAL BID)**  
**(for Foreign Purchase Orders)**

Sl. No.	Particulars	Bidder's confirmation
1	<b>Price basis:</b> Firm i.e., from the date of PO to completion of supply [Price Variation Clause (PVC) not acceptable]	Acceptable / Not acceptable
2	EMD as mentioned in RFQ	Submitted/Not submitted
3	CEBG as detailed in clause 19	Acceptable / Not acceptable
4	<b>Terms of Payment:</b> Against "SIGHT DRAFT" on presentation of documents to our bankers. <del>(a) 90 % is payable on negotiation of complete set of original documents balance 10 % after completion of commissioning or on submission of PBG</del> (b) 80 % is payable on negotiation of complete set of original documents, 10% after commissioning & balance 10% against submission of PBG (where both Commissioning & PBG are applicable). (c) Deviation if any please specify	(a) Acceptable / Not acceptable (b) Acceptable / Not acceptable (c)
5	<b>BHEL's penalty clause:</b> (a) Delay in delivery as per PO delivery date will result in penalty of penalty of 0.5 % (half percent) per week at the basic price of the goods/E&C for the undelivered quantity, subject to a maximum of 10% individually. (b) Deviation if any Please specify	(a) Acceptable / Not acceptable (b)
.6	<b>Performance Bank guarantee (If applicable):</b> PBG for 10% of the basic material cost shall be furnished in the BHEL prescribed format as detailed in clause 20.	Yes / No
7	<b>Terms of delivery:</b> (a) F.O.B international Airport/Seaport as per clause 19 (a)(Indicate name of International Airport/Seaport) (b) Deviation if any Please specify	(a)Acceptable / Not acceptable (b)
8	<b>Warranty:</b> (a) 18 months from the date of dispatch or 12 months from the date of commissioning or as specified in RFQ (b) Deviation if any Please specify	(a)Acceptable / Not acceptable (b)
9	<b>Delivery period:</b> Indicate number of weeks from the date of issue of Purchase order	_____Weeks
10	<b>Validity:</b> (a) Quotation should remain valid for a period of 90 days from the due date (b) Deviation if any Please specify	(a) Acceptable / Not acceptable (b)
11	<b>Bank charges(If applicable):</b> (a) Bank charges within India is to BHEL account and outside India is to Vendor's account (b) Deviation if any Please specify	(a) Acceptable / Not acceptable (b)
12	Weight and Dimension of consignment with packing	Furnished / To be furnished

Signature of tenderer / with seal

**ANNEXURE-B**

**COMMERCIAL TERMS (to be enclosed with TECHNO-COMMERCIAL BID)**  
**(For Indigenous Purchase Orders)**

Sl.No.	Particulars	Bidder's confirmation
1	<b>Price basis:</b> Firm i.e., from the date of PO to completion of supply [Price Variation Clause (PVC) not acceptable]	Acceptable / Not acceptable
2	EMD as mentioned in RFQ	Submitted/Not submitted
3	CEBG as detailed in clause 19	Acceptable / Not acceptable
4	<b>Excise duty:</b> If applicable indicate %.	Applicable / Not applicable ED: _____%
5	<b>Sales tax:</b> If applicable indicate %	Applicable / Not applicable (a) VAT _____% (b) CST _____% against form C
6	<b>Service tax:</b> If applicable indicate %	Applicable / Not applicable ST: _____%
7	<b>Payment terms:</b> <del>(a) 90 % basic payment + 100% taxes, duties &amp; freight charges with 45 days credit &amp; balance 10 % after completion of commissioning or on submission of PBG</del> (b) 80 % basic payment + 100% taxes, duties & freight charges with 45 days credit, 10% after commissioning & balance 10% against submission of PBG ( where both commissioning & PBG are applicable) (c) Deviation if any please specify	(a) Acceptable / Not acceptable (b) Acceptable / Not acceptable (c)
8	<b>BHEL's penalty clause:</b> (a) Delay in delivery as per PO delivery date will result in penalty of penalty of 0.5 % (half percent) per week at the basic price of the goods/E&C for the undelivered quantity, subject to a maximum of 10% individually. (b) Deviation if any Please specify	(a) Acceptable / Not acceptable (b)
9	<b>Performance Bank guarantee (PBG) (If applicable):</b> PBG for 10% of the basic material cost shall be furnished in the BHEL prescribed format as per clause 20.	Yes / No
10	<b>Terms of delivery:</b> (a) Ex- EDN or ESD / BHEL, Bangalore (Free delivery to BHEL Bangalore including freight, packing & forwarding charges) (b) Deviation if any Please specify	(a) Acceptable / Not acceptable (b)
11	<b>Warranty:</b> (a) 18 months from the date of dispatch or 12 months from the date of commissioning or as specified in RFQ (b) Deviation if any Please specify	(a) Acceptable / Not acceptable (b)
12	<b>Delivery period:</b> Indicate number of weeks from the date of issue of Purchase order	_____ Weeks
13	<b>Validity:</b> (a) Quotation should remain valid for a period of 90 days from the due date (b) Deviation if any Please specify	(a) Acceptable / Not acceptable (b)
14	<b>Bank charges (If applicable):</b> (a) All Bank charges to vendor's account (b) Deviation if any Please specify	(a) Acceptable / Not acceptable (b)
15	Weight and Dimension of consignment with packing	Furnished / To be furnished

Signature of tenderer / with stamp

**ANNEXURE- C**

**LIST OF INTERNATIONAL AIRPORTS**

Sl. No	Country	Air Ports
1	Austria	Vienna, Linz, Graz
2	Australia	Sydney, Melbourne, Perth
3	Belgium	Antwerp, Brussels
4	Canada	Toronto, Montreal
5	China	Shangai
6	Cyprus	Lamaca
7	Czech Republic	Prague (Via Frankfurt)
8	Denmark	Copenhagen
9	Egypt	Cairo
10	Finland	Helsinki
11	France	Paris (Rossy), Lyon
12	Germany	Darmstadt, Manihem, Nurnberg, Hamburg, Stuttgart, Munich, Koln, Dusseldorf & Hannover, Frankfurt, Berlin
13	Hongkong	Hongkong
14	Italy	Rome, Milan, Turin, Bologna, Florence
15	Ireland	Dublin
16	Isrel	Telaviv
17	Japan	Tokyo, Osaka
18	Malaysia	Kaulalampur, Penang
19	Neatherlands	Amsterdam, Rotterdam
20	Newzealand	Auckland
21	Norway	Oslo
22	Oman	Muscat
23	Philiphines	Manila
24	Romania	Bucharest
25	Russia	Moscow
26	Saudi Arabia	Riyad
27	Singapore	Singapore
28	Slovakia	Bartislowa
29	South Africa	Johannesburg, Durban
30	South korea	Kimpo
31	Spain	Barcelona
32	Sweden	Stockholm, Gothenburg, Milano
33	Switzerland	Basle, Zurich, Geneva
34	Taiwan	Taipei
35	U.A.E.	Dubai
36	U.K.	Landon (Heathrow), Newcastle, Oxford, Cheltham, Bristol, Wellingborough, Birmingham, East Midland, Manchester, Leeds, Glasgow.
37	U.S.A.	Newyork, Chicago, Sanfrancisco, Los Angeles, Atlanta
38	Ukraine	Kiev



**ANNEXURE – D**

**CONTRACT EXECUTION BANK GUARANTEE BOND**

This deed of guarantee made this ..... day of ..... 20... by the..... Bank Ltd, (hereinafter referred to as “the Bank”) in favour of Bharat Heavy Electricals Limited, Bangalore having its registered Office at New Delhi with its Unit Office at Bangalore where as M/s..... having its registered office at ..... (hereafter called the “the Contractor”) have entered in to contract with Bharat Heavy Electricals Limited, Bangalore for the supply of ..... vide Purchase Order No ..... dated .....

1. We ..... Bank Ltd, do hereby undertake to pay to Bharat Heavy Electricals Limited, Bangalore an amount not exceeding Rs..... against any loss or damage caused to or suffered or would be caused to or suffered by Bharat Heavy Electricals Limited, Bangalore by reason of any breach by the said Contractor of any of the terms or conditions contained in the said Purchase Order.

2. We, ..... Bank Ltd, do hereby undertake to pay the amounts due and payable under this guarantee without any demur, merely on a demand from Bharat Heavy Electricals Limited, Bangalore stating that the amount claimed is due by way of loss or damage caused to or would be caused to or suffered by Bharat Heavy Electricals Limited, Bangalore by reason of any breach by the said Contractor of any of the terms or conditions contained in the said Purchase Order or by reason of the Contractor’s failure to perform the said Purchase Order. Any such demand made on the Bank shall be conclusive as regards the amount due and payable by the Bank under this guarantee. However, our liability under this guarantee shall be restricted to an amount not exceeding Rs.....

3. We, ..... Bank Ltd, further agree to the guarantee herein contained shall remain in full force and effect during the period that would be taken for the performance of the said Purchase Order and that it shall continue to be enforceable till all the dues of Bharat Heavy Electricals Limited, Bangalore under or by virtue of the said Purchase Order have been fully paid and its claims satisfied or discharged or till Bharat Heavy Electricals Limited, Bangalore certifies that the terms and conditions of the said Purchase Order have been fully and properly carried out by the said Contractor and accordingly discharges the guarantee. Unless a demand or claim under this guarantee is made on us in writing on or before the ..... we shall be discharged from all liability under this guarantee thereafter. But where such claim or demand has been preferred by the Company with the Bank before the expiry of the said date the claim shall be enforceable and Payable only by any one of the BHEL Consortium Banks in India ( List is attached herewith) notwithstanding the fact that the said enforcement is effected after the said date

For the purpose of this clause, any letter making demand on the Bank by Bharat Heavy Electricals Limited, Bangalore dispatched by Registered Post with Ack. Due or by Telegram or by any Electronic media addressed to the Bank ( **any one of the BHEL Consortium Banks as per list attached as selected by the vendor**) shall be deemed to be the claim / demand in writing referred to above irrespective of the fact as to whether and when the said letter reaches the Bank, as also any letter containing the said demand or claim is lodged with the Bank personally.

4. We,.....Bank Ltd, further agree with Bharat Heavy Electricals Limited, Bangalore that Bharat Heavy Electricals Limited, Bangalore shall have the fullest liberty without our consent and without affecting in any manner our obligations hereunder to vary any of the terms and conditions of the said Purchase Order or to extend time of performance by the said contractor from time to time or to postpone for any time or from time to time any of the powers exercisable by Bharat Heavy Electricals Limited, Bangalore against the said Contractor and to forbear or enforce any of the terms and conditions relating to the said Purchase Order and we shall not be relieved from our liability by reason of any such variation, or extension being granted to the said Contractor or for any forbearance, act or omission on the part of Bharat Heavy Electricals Limited, Bangalore or any indulgence by Bharat Heavy Electricals Limited, Bangalore to the said Contractor or by any such matter of thing whatsoever which under the law relating to sureties would but for this provision have effect of so relieving us.

5. Any claim or dispute arising under the terms of this document shall only be enforced or settled in the Courts at Bangalore.

We, ..... Bank Ltd, lastly undertake not to revoke this guarantee during its currency except with the previous consent of Bharat Heavy Electricals Limited, Bangalore in writing.

In witness whereof we..... (indicate the name of Bank) have hereunto setout Bank

Seal the..... day ..... month 201

**The contact details of the Issuing Bank such as Email ID, Phone No. and Fax No. should be indicated in the CEBG. Also please note that the CEBG should be forwarded to us with the covering letter of the issuing Bank with signature and seal.**

**(1) It should be typed in the Rs. 100 value of stamp paper.**

**(2) It should be signed by TWO bank officials with Rubber stamp containing names & employee numbers of bank officials.**

**(3) It should be submitted with bank covering letter with sign and seal of the bank official.**

Please note that issuance of the CEBG without meeting the above requirement will render the document invalid.

---



**ANNEXURE-E**

**PERFORMANCE BANK GUARANTEE  
(FOR FOREIGN PURCHASE ORDERS)**

**BANK NAME AND ADDRESS**

Bharat Heavy Electricals Limited (BHEL),  
Electronics Division,  
PB No. 2606,  
Mysore Road,  
BANGALORE- 560 026  
INDIA

Dear Sir,

Ref: CONTRACT PERFORMANCE GUARANTEE.

WHEREAS you have entered into a contract reference No PO NO. \_\_\_\_\_ with M/s \_\_\_\_\_ having its registered office at \_\_\_\_\_ for the supply of \_\_\_\_\_ as detailed in your purchase order No. \_\_\_\_\_ which is hereinafter referred to as "the said contract" and WHEREAS M/s \_\_\_\_\_ has undertaken to produce a Bank Guarantee for 10% ( Ten Percent ) of \_\_\_\_\_ the contract price amounting to \_\_\_\_\_ ( \_\_\_\_\_ ) to secure its obligations to Electronics Division, BHEL having its registered office at New Delhi for the performance of the contract including the warranty of the equipment supplied, We \_\_\_\_\_ Bank \_\_\_\_\_ hereby expressly, irrevocably and unreservedly undertake and guarantee as principal obligors on behalf of M/s \_\_\_\_\_ that in the event Bharat Heavy Electricals Ltd. (B.H.E.L.) declares to us in writing that M/s \_\_\_\_\_ has not fulfilled any obligation according to the contractual obligation of the said contract, to pay you on demand and without demur to Bharat Heavy Electricals Ltd., Electronics Division , Mysore Road, P.B.No. 2606, Bangalore-560 026, India an amount of \_\_\_\_\_ (in words \_\_\_\_\_ ) subject to as may be determined below:

- 1) Notwithstanding any right M/s. \_\_\_\_\_ may have directly against you or any disputes raised by M/s \_\_\_\_\_, Your written demand shall be conclusive evidence to us that repayment is due under the terms of the said contract and shall be binding on us.
- 2) We shall not be discharged or released from this undertaking and Guarantee by any arrangements, variations made between you and M/s. \_\_\_\_\_ with or without our consent and Knowledge or by any alterations in the obligations of M/s. \_\_\_\_\_ by any forbearance whether as to payment, time, performance or otherwise.
- 3) This guarantee shall remain valid until the end of twenty-four weeks after the close of the warranty period or until the same is reported by BHEL to us whichever is earlier.
- 4) We agree and undertake not to revoke this guarantee during its validity unless discharged in writing by you subject to the provision of clause (7) below.



- 5) This guarantee shall be a continuing guarantee subject to the foregoing and shall not be discharged by any change in the constitution of the Bank or M/s. \_\_\_\_\_.
- 6) This guarantee shall be governed by and constructed in accordance with the Laws of India.
- 7) At any time \_\_\_\_\_ Bank may render this guarantee null and void by paying to Bharat Heavy Electricals Ltd. the full amount being \_\_\_\_\_ (in words \_\_\_\_\_)

For and on behalf of Bank  
by its Authorised Signatory

**Note:**

- (1) To be executed in INR 100 Non-Judicial stamp paper by any authorized Indian Bank.
- (2) To be submitted directly by banker to concerned executive in purchase dept., Please give BHEL address to banker.
- (3) Do not enclose with Bank document.
- (4) Any Modification & omissions to this are not permitted



**ANNEXURE - F**

**PERFORMANCE BANK GUARANTEE  
(FOR INDIGENOUS PURCHASE ORDERS)**

THIS DEED OF GUARANTEE made and executed on the \_\_\_\_\_ day of \_\_\_\_\_ (year), by the \_\_\_\_\_ (Bank), registered under the Companies Act 1956/Nationalised Bank constituted under the Banking Companies (acquisition and transfer of undertakings) Act constituted under the State Bank of India Act / Subsidiary Banks Act, having its registered / head office at \_\_\_\_\_ represented herein by its Branch Manager / authorised representative Sri. \_\_\_\_\_ & Sri. \_\_\_\_\_ (Hereinafter called 'guarantor ' which term shall mean and include its successors and assigns)

**IN FAVOUR OF BHARAT HEAVY ELECTRICALS LIMITED**

\_\_\_\_\_ (Buyer's Name), a company registered under the companies Act, 1956 having its registered office at BHEL House at Siri Fort , New Delhi-100 049 and its Electronics Division at Mysore road, Bangalore-26 (hereinafter referred to as the 'Company' Which term shall include its successors and assigns):

Whereas the company has placed an order on \_\_\_\_\_ (State the name of the company / firm and its address) (hereinafter referred to as the 'Supplier' which term shall mean and include its liquidators, successors and assign) for the supply of system under order / Contract No \_\_\_\_\_ Dt \_\_\_\_\_.

AND WHEREAS the supplier has agreed to supply the materials and carryout the works as detailed and in accordance with the terms set out in the said order/contract.

AND WHEREAS the company is not required to pay to the supplier a sum of Rupees \_\_\_\_\_ being the 10% of the value of the goods supplied / Works performed / Services rendered under the said order / contract between the supplier and the company, till the company is satisfied with the mechanical Warranties and the performance standards stipulated in the said order / contract between the company and the supplier has been duly fulfilled, except against a Bank Guarantee for the said sum of Rs \_\_\_\_\_ in favour of the company by reputed Bank, in which case the company has agreed to make payment to the supplier of the said sum of Rupees \_\_\_\_\_ being ( ...% ) of the value of the goods supplied / Works performed / Services rendered under the agreement between the supplier and the company and the Guarantor has at the request of the supplier, agreed to furnish this Guarantee subject to the terms and conditions stated below:

NOW THIS DEED WITNESSES THAT IN pursuance of the above said agreement, the guarantor hereby agrees and covenants With company is as follows :-

- 1) That during the period this contract of Guarantee remains effectual, the guarantor shall be liable in respect of the amount due and owing to the company in respect of the payments to the extent of Rs \_\_\_\_\_ (in words) \_\_\_\_\_ against any loss or damage caused to or suffered by the company by reasons of any breach of the terms of the said order / contract / Agreement by the supplier.
- 2) The Guarantor hereby undertakes to pay the amounts due and payable under this guarantee without any demur, merely on demand from the company intimating that the amount claimed is due by way of loss or damage caused to or suffered or would be caused or suffered by the supplier of any terms contained in the said order / contract. Any such demand made on the guarantor shall be conclusive as regards the amount due and payable by the Guarantor irrespective of the fact whether the Contractor / supplier admits or denies.

- 3) The Guarantor further agrees that the agreement herein contained shall remain in force and effect till all the supplies to be made / Works to be performed / Services to be rendered under the said order / contract / agreement are completed to the entire satisfaction of the company or till company certifies that the terms and conditions of the said order / contract / agreement have been fully and properly carried out by the said supplier and accordingly discharges the Guarantee. Unless a demand or claim under this guarantee is made on the guarantor in writing on or before the expiry of claim period indicated in clause 6 below , the guarantor shall be discharged from all the liability under this guarantee thereafter.
- 4) The guarantor further agrees with the company that the company shall have the fullest liberty without the consent of the guarantor and without effecting in any manner the obligations of the guarantor hereunder to vary any of the terms of the said order / contract / agreement or extend the time of performance by the said supplier from time to time or refrain from exercising the power exercisable by the company against the said supplier or to forebear or omit to enforce any of the terms and conditions relating to the said order / contract / agreement, and the guarantor shall not be relieved of its liability in whole or in part , by reason of any act, commission or forbearance on the part of the company or by reason of any such variation, or extension being granted to the said supplier or by reason of any such matter or thing whatsoever which under the law relating to sureties would but for this provision have effect of so relieving the guarantor.
- 5) The guarantor undertakes not to revoke this guarantee during its currency except with the previous consent of the company in writing.
- 6) Notwithstanding anything herein above contained, the liability of the guarantor under these presents is restricted to Rs\_\_\_\_\_. The guarantee shall be in force till its expiry on \_\_\_\_\_ unless a demand is made on the guarantor within SIX months from the date of expiry, all the liability of the guarantor under this guarantee shall stand fully discharged. The decision of the claimant in regard to breach of contract is final and binding on the Bank.

IN WITNESS whereof, the guarantor, acting through its authorised representative has executed this deed of Guarantee on the day, month and year first above written.

(Seal of the Bank to be affixed )

WITNESS

1.

2.

**ANNEXURE - G****BHEL MEMBER BANKS (CONSORTIUM BANKS)**

**PBG SHALL BE ISSUED FROM THE FOLLOWING BANKS OR THEIR BRANCH OFFICES ONLY**

1	STATE BANK OF INDIA
2	PUNJAB NATIONAL BANK
3	HDFC BANK
4	SYNDICATE BANK
5	CANARA BANK
6	INDIAN BANK
7	ST. BANK OF HYDERABAD
8	ICICI BANK
9	STANDARD CHARTERED BANK
10	UCO BANK
11	KOTAK MAHINDRA
12	ORIENTAL BANK OF COMMERCE
13	STATE BANK OF TRAVANCORE
14	CENTRAL BANK
15	IDBI BANK
16	FEDERAL BANK
17	HSBC LTD
18	DEUTSCHE BANK
19	CORPORATION BANK
20	CITI BANK
21	BANK OF BARODA
22	ABN AMRO BANK
23	UNITED BANK OF INDIA
24	VIJAYA BANK
25	UNION BANK OF INDIA
26	PUNJAB & SIND BANK
27	ANDHRA BANK
28	BANK OF INDIA
29	AXIS BANK

---

The list of BHEL approved consortium bank may be updated from time to time. Please check with the purchasing executives for correctness.

**ANNEXURE – H**

This format is applicable only to Indian Suppliers/ Agents supplying indigenous portion of Foreign Purchases.

<b>SEARP (SRF) Clause No</b>	<b>Detail</b>
	<b>Name &amp; address of the firm</b>
<b>1.0</b>	<b>Products/ Systems / Services being considered for</b>
<b>2.0</b>	<b>General Information</b>
2.2	Name of Chief Executive
2.3	Details of authorized signatory
<b>3.0</b>	<b>Ownership Information</b>
3.1	Type of firm
3.2	Nature of Business <ul style="list-style-type: none"> <li>• <i>Attach <b>authorization letter</b> and <b>agency agreement</b> from Principal ( from whom capital equipment is procured)</i></li> <li>• <i>Attach copy of declaration from Foreign Principal for <b>total guarantee/ warranty of indigenous supplies</b></i></li> </ul>
3.3	Year of establishment
3.4	Year of commencement of business
<b>4.0</b>	<b>Registration particulars</b>
4.1	Permanent Account No.
4.2 / 4.3	Sales Tax / TIN no
4.6	Service tax no. (in case of E&C)
<b>5.0</b>	<b>Organisational strength</b>
<b>6.0</b>	<b>Other particulars</b>
6.1	If the company is already registered with other units
6.2	Directors/ Partners, if related to any BHEL Employee
6.9	If any Ex BHEL Personnel employed by the Company
6.12	Details of pending legal issues with BHEL
6.13	Bank Account information
<b>9.0</b>	<b>Financial information</b>
9.6	Sales/ Turnover details of last 3 years (or from the date of incorporation whichever is less )



**ANNEXURE – I**

Annexure - I

**Certificate by Chartered Accountant on letter head**

This is to Certify that M/S .....  
(hereinafter referred to as 'company') having its registered office at  
..... is registered under MSMED Act 2006, (Entrepreneur  
Memorandum No (Part-II) ..... dtd:.....,  
Category: ..... (Micro/Small)). (Copy enclosed).

Further verified from the Books of Accounts that the investment of the company as on  
date..... as per MSMED Act 2006 is as follows:

1. **For Manufacturing Enterprises:** Investment in plant and machinery (i.e. original cost excluding land and building and the items specified by the Ministry of Small Scale Industries vide its notification No.S.O.1722(E) dated October 5, 2006 :  
Rs.....Lacs
2. **For Service Enterprises:** Investment in equipment (original cost excluding land and building and furniture, fittings and other items not directly related to the service rendered or as may be notified under the MSMED Act, 2006:  
Rs.....Lacs

The above investment of Rs.....Lacs is within permissible limit of  
Rs.....Lacs for .....Micro / Small (Strike off which is not applicable)  
Category under MSMED Act 2006.

Date:

(Signature)

Name -

Membership number -

Seal of Chartered Accountant

\*\*\*\*