



Techno Commercial Memorandum of Understanding for supplying
IS 3589 PIPES

Between

Party I

M/s. BHEL , PIPING CENTRE , 600 017

&

Party II

VENDOR SIGNATURE :

DATE : 31.03.2015

VENDOR NAME :

VENDOR ADDRESS :

M. THANGARAJ, M.E., M.B.A., M.S.
Manager / Purchase
Pipes, Electrodes Transport Bills
ICT Products & AMC
BHEL / Piping Centre
T. Nagar, Chennai - 600 017

VENDOR



Memorandum of Understanding (MOU) for supplying IS 3589 PIPES

Section – General

1.0 General

- 1.1 This Techno commercial MOU is signed for supplying IS 3589 PIPES as per the BHEL standard specification, so that these details need not be discussed repeatedly for future supplies.
- 1.2 The various aspects covered in this MOU are as follows and it is agreed to follow the same without any deviation.
 - 1.2.1 Commercial requirements as per point 2.0
 - 1.2.2 Technical requirements as per 3.0
 - 1.2.3 General Terms 4.0
 - 1.2.4 Annexure – I (New Rules and Regulations of Price Evaluation)
- 1.3 The Party II agrees to take no deviation while submitting the offer.
- 1.4 If any deviation is taken in the technical, commercial and quality points in the offer submitted by Party II, the offer will be rejected straight away. Any request for revaluation will not be entertained.
- 1.5 If BHEL has any other requirement/deviation from the MOU for a particular Enquiry, it shall be clearly given in the Enquiry itself. Confirmation for that requirement/deviation alone is to be given by the bidder. All other terms and conditions shall be as per the MOU. Such deviations/requirements, if any, shall pertain to that enquiry alone and MOU shall be followed for all other enquiries unless otherwise specified.
- 1.6 This MOU shall be valid from 01.04.2015.
- 1.7 The MoU will stand valid for TWO (02) Years from the date of finalization of the MOU. The MoU validity may be extended even after the initial period of TWO years if required by M/s BHEL, with the consent of party II. However, in case any change is required; the MOU may be amended before the expiry of the validity with mutual consent.

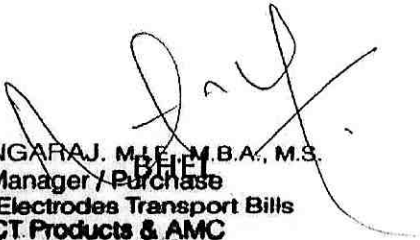

M. THANGARAJ, M.E., M.B.A., M.S.
Manager / Purchase
Pipes, Electrodes Transport Bills
ICT Products & AMC
BHEL / Piping Centre
T. Nagar, Chennai - 600 017

VENDOR



2.0 COMMERCIAL POINTS:

2.1	PRICE	Firm till completion of order.
2.2	DELIVERY TERMS / DESTINATION *	F.O.R. DESTINATION (Destination will be indicated in the Enquiry)
2.3	PACKING&FORWARDING	In Vendor scope.
2.4	FREIGHT	In Vendor scope. Prices as quoted by vendor in Price Bid/RA Template. BHEL also has the option of despatching the Pipes through BHEL approved road carriers. List of authorised transporters will be furnished along with Enquiry if this option is exercised by BHEL. Changes if any, in the transporters shall be communicated from time to time.
2.5	SERVICE TAX ON FREIGHT	Service Tax on transportation, if chargeable to BHEL, shall be clearly indicated in percentage. Payment will be made against submission of Proof of Payment of Service Tax.
2.6	TRANSIT INSURANCE	In Vendor Scope. Prices as quoted by vendor in Price Bid/RA Template.
2.7	EXCISE DUTY in %	Extra as applicable during the tenure of the contract. Applicability of taxes, %age and value has to be clearly indicated while submitting the bid.
2.8	SALES TAX/VAT in %	
2.9	OCTROI	If any, to supplier's account only.
2.10	TERMS OF PAYMENT	100% payment within 45 days from date of dispatch documents. Despatch documents to be sent to BHEL directly and not routed thro' bank. Payment shall be processed only after receipt of site acknowledgement. Bank Guarantee for 10% of the PO value shall be submitted valid upto the end of guarantee period.

M. THANGARAJ, B.E., M.B.A., M.S.
Manager / Purchase
Pipes, Electrodes Transport Bills
ICT Products & AMC
BHEL / Piping Centre
T. Nagar, Chennai - 600 017

VENDOR

**BHEL/PIPING CENTRE/MOU/IS 3589 PIPES**

2.11	LD CLAUSE	"If the supplier fails to deliver the Raw material/Components/Equipments within the period specified in the contract the purchaser shall deduct Liquidated Damages , a sum equivalent to 0.5% of the price for each week of delay or part thereof up to a maximum of 10% of the price of delayed/total purchase order value/ undelivered portion to be reckoned from the contract delivery date to cargo readiness date. (i.e, Date of LR).
2.12	OFFER VALIDITY	Minimum 90 days from the date of Technical Bid Opening
2.13	DELIVERY	Delivery shall be 3-4 months from the date of PO. Any changes, if any, shall be indicated in the Enquiry. Bidder has to strictly confirm to the delivery terms. Bids not complying with the delivery period are liable for rejection.
2.14	PBG (BANK GUARANTEE)	Bank Guarantee for 10% of the PO value shall be submitted valid upto the end of guarantee period.
2.15	RISK PURCHASE CLAUSE	Your confirmation to our standard risk purchase clause that alternatively the Purchaser at his option will be entitled to terminate the contract and to purchase elsewhere at the risk and cost of the seller either the whole of the goods or any part which the supplier has failed to deliver or dispatch within the time stipulated as aforesaid or if the same were not available, the best and the nearest available substitute there for. The supplier shall be liable for any loss which the purchaser may sustain by reason of such risk purchases in addition to penalty at the rate mentioned in clause 2.11(LD) above.
2.16	BHEL STANDARD GUARANTEE CLAUSE	Your confirmation to our standard Guarantee clause that the materials are to be guaranteed for satisfactory performance for a period of 24 months from the date of dispatch or 18 months from the date of commissioning / putting into use whichever is earlier and if any defect is noticed during the above period, the same shall be rectified/replaced free of cost on FOR / Destination basis



M. THANGARAJ E., M.B.A., M.S.
Manager / Purchase
Pipes, Electrodes Transport Bills
ICT Products & AMC
BHEL / Piping Centre
T. Nagar, Chennai - 600 017

VENDOR



BHEL/PIPING CENTRE/MOU/IS 3589 PIPES

		within a reasonable time, maximum limited to the agreed delivery period . To this effect a Guarantee certificate should be sent along with the dispatch documents in the event an order is placed on you.
2.17	E-PROCUREMENT	All BHEL Tenders shall be processed through E-procurement unless otherwise indicated in Enquiry. Bidders have to equip themselves with necessary digital signatures for the same. Necessary guidance would be provided to you by BHEL service providers as and when required.
2.18	PRICE BID	For an enquiry the prices will be decided either by Reverse auction or Price bid Opening mode. This shall be decided after techno-commercial evaluation. For new rule and regulations pertaining to price evaluation, refer to Annexure - I
2.19	RESPONSE	<p>If you are not interested / not in a position to participate in the tender, please send regret letter, before due date of the tender.</p> <p>Not giving any response(i.e, not even submitting Regret letter) for more than THREE consecutive occasions <u>MAY LEAD TO SUPPLIER BEING PUT ON "HOLD"</u>.</p> <p>Also, Not quoting(i.e, not submitting an offer) for FOUR consecutive occasions or for all enquiries in the last two years(whichever is earlier) <u>MAY LEAD TO DELETION OF SUPPLIER FROM BHEL PMD VENDOR LIST.</u></p> <p>Also, backing out after submitting the offer is not acceptable to BHEL. Appropriate action would be taken as per BHEL procedures in such cases. If not interested, it is advised to inform us via Regret Letter before the due date of tender.</p>

M. THANGARA M.E.E., M.B.A., M.S.
Manager / Purchase
Pipes, Electrodes Transport Bills
ICT Products & AMC
BHEL / Piping Centre
T. Nagar, Chennai - 600 017

VENDOR

**BHEL/PIPING CENTRE/MOU/IS 3589 PIPES**

2.20	PURCHASE PREFERENCE TO MSE VENDORS	<p>In case the supplier belongs to MSEs (Micro Small Enterprises), Registration copy in this respect shall be submitted along with the offer.</p> <p>Further if MSEs are owned by the Scheduled Caste or the Scheduled Tribe entrepreneurs the same may be intimated.</p> <p>The following are the benefits for the MSEs :-</p> <ol style="list-style-type: none">1. MSEs are given tender documents free of cost and are exempted from payment of earnest money (EMD), if any insisted in the Tender.2. In tender, participating MSEs quoting price within price band of L1+15% shall also be allowed to supply a portion of requirement by bringing down their price to L1 price in a situation where L1 price is from someone other than a MSE and such MSE shall be allowed to supply up to 20% of total tendered value. In case of more than one such MSE, the supply shall be shared proportionately.
2.21	SPLITTING OF ORDER	<p>Wherever necessary as decided by BHEL , order may be split in to two or more suppliers. The intention and manner of splitting will be mentioned in the Enquiry itself.</p>
2.22	LOADING CRITERIA	<p><u>Payment Terms</u> - BHEL operates various payment terms for the tenders floated and bidders should accept the payment terms specified in the tender. Loading of any deviation in the payment terms w.r.t. NIT terms shall be referenced as follows;</p> <ol style="list-style-type: none">(a) 'Base rate of SBI (as applicable on the date of bid opening; Techno-commercial bid opening in case of two part bids) + 6%', shall be considered for loading for the period of relaxation sought by bidders.(b) Wherever LC payment terms are not offered in NIT and the same is insisted by bidder(s), all LC related bank charges to be incurred by BHEL shall also be loaded.(c) In case of deviation w.r.t. LC payment terms offered in NIT, the loading shall be done for all LC related bank charges to be incurred by BHEL. <p><u>Liquidated Damages</u> - Any loading on LD clause shall be to the extent to which it is not agreed to by the bidder (at offered value).</p>



M. THANGAVELU, I.E., M.B.A., M.S.
Manager / Purchase
Pipes, Electrodes Transport Bills
ICT Products & AMC
BHEL / Piping Centre
T. Nagar, Chennai - 600 017

VENDOR



BHEL/PIPING CENTRE/MOU/IS 3589 PIPES

2.23	GENERAL	<ul style="list-style-type: none">-BHEL reserves right to cancel a tender without assigning any reason what so ever.-Lowest prices received against BHEL tenders does not ensure ordering. BHEL reserves right not to consider the same.-BHEL reserves right to negotiate with the L1 vendor.-Deviation taken after placement of order will not be accepted (Both On technical and commercial grounds)- Suppliers to analyze in detail, at the time of submission of offer with reference to our "delivery" requirement of Pipes and confirm compliance.-Supplier to ensure correct & timely submission of all original test certificates. There should not be any discrepancies. This will lead to unnecessary time wastage in clarification and revision.-All offers shall be sent before the due date. Offers shall be dropped into the tender box located at BHEL/PC, Purchase Department.-No recording devices such as camera, voice recorder, mobile phones etc are allowed during tender opening.
------	---------	---



M. THANGARAJ, M.E., M.B.A., M.S.
Manager / Purchase
Pipes, Electrodes Transport Bills
ICT Products & AMC
· BHEL / Piping Centre
T. Nagar, Chennai - 600 017

VENDOR



3.0 TECHNICAL REQUIREMENTS:

<u>Pipes Dia(OD) below 1000mm – Despatch to Trichy Stores / Project Site</u>		
3.1		(a) For smaller Diameter Pipes below 1000mm, the Pipes shall have square ends. EP, if any, specifically indicated in the Enquiry/PO shall be taken care off. (b) Spider Arrangement is not applicable . (c) The above Pipes of Dia. below 1000mm getting despatched to Trichy Stores shall have quantity tolerance of +0 / -2 Meters per size of PO quantity. The above Pipes of Dia. below 1000mm getting despatched to Project Site shall have quantity tolerance of +2 / -2 Meters per size of PO quantity. (d) The Length of each Pipe shall be 7 to 12.5 Meters. (e) NDE TESTING AS PER CLAUSE 5.1 OF TDC:TDG:07:06 DT. 04.05.12 – 100% Hydrotest on each pipe + Radiography Test for 100 mm Weld Length at both the ends for 10% of the pipes
<u>Pipes Dia (OD) above 1000mm – Despatch to Project Site</u>		
3.2		(a) The above Pipes shall be Edge prepared as per Drawing No.4-80-999-93079 Rev. 00. EP as per attached drawings (b) Spider Arrangement shall be applicable as per Drawing No. 4-80-999-93078 Rev. 00. Tolerance as per ITB (c) The Length of each Pipe shall be 7 to 12.5 Meters. (d) Total Quantity Tolerance shall be +2/- 2 Meters per Size of the PO Quantity. Tolerance as per ITB (e) NDE TESTING AS PER CLAUSE 5.2 OF TDC:TDG:07:06 DT. 04.05.12 SHALL BE DONE BY ANY ONE OF THE FOLLOWING OPTIONS. VENDORS TO TICK AND INDICATE THEIR CHOICE BELOW – i) 100% Hydrotest alongwith Radiography Test for 100 mm Weld Length on both the ends of each pipe. <input type="checkbox"/> ii) 100% Ultrasonic Test + 10% Radiography Test on weld length (including all T-joints and 100 mm Weld length at both the ends) for each pipe. <input type="checkbox"/> iii) 100% Radiography Test on weld length of each pipe. <input type="checkbox"/>
3.3	PAINTING SCHEME	Applicable Painting Scheme shall be sent along with the Enquiry for each Project. If no such Painting scheme is sent, Painting shall be as per TDC:TDG:07, Rev 06 dt. 04.05.2012.
3.4	TECHNICAL DELIVERY CONDITIONS	All other technical requirements are as per Technical Delivery Condition TDC:TDG:07 Rev. 06 dt. 04.05.2012 or latest revision, as on date. The TDC is also a part of MoU.
3.5	QUALITY PLAN	Quality plan, in line with BHEL specification shall be submitted by the L1 vendor immediately after placement of order. Manufacturing shall be taken up as per BHEL approved QP only.

M. THANGARAJ, M.E., M.B.A., M.S.
 Manager / Purchase
 Pipes, Electrodes Transport Bills
 ICT Products & AMC
 BHEL / Piping Centre
 T. Nagar, Chennai - 600 017

VENDOR



3.6	INSPECTION	Inspection call shall be raised by the vendor as per the approved Quality Plan. Inspection call shall be given atleast 14 days in advance to the required inspection (as per approved QP) so that BHEL inspectors can plan their visit accordingly. Inspection call letter should contain all details pertaining to type of inspection, manufacturing schedule, inspection dates etc. If the materials are not ready on the date of visit by BHEL inspector against specific call for inspection by vendor, all the expenses incurred for the visit shall be liable for recovery from the invoices of the vendor. Further, this will also have an adverse bearing on the performance rating of the vendor.
-----	------------	---

4.0 GENERAL TERMS

One original + two copies of Quality Documents, as listed below shall be sent to Purchase / Piping centre BHEL Chennai immediately after the shipment / despatch of Items.

- 1) BHEL / BHEL authorised Third Party Inspection Agency Report
- 2) Works TC
- 3) Hydro Test Report (as applicable)
- 4) NDE reports (as applicable)
- 5) Dimensional report
- 6) Mechanical, Chemical Analysis and other Lab test reports
- 7) Confirmation report to BHEL Specification.
- 8) Basic raw material (Mill) TC
- 9) Other documents as per TDC / approved QP/IS 3589/other Specifications.

All the above documents are to be submitted in soft copy apart from the hard copy, as above.

Year of Code for the standards shall be latest and the specific year is to be mentioned in the Manufacturer's test certificates.

If entire PO Quantity is manufactured in one lot but dispatched in a phased manner, inspection report should be sent along with the first consignment and the same shall be resubmitted for subsequent consignments alongwith a photocopy of the original inspection report.

The following despatch documents should be submitted directly to BHEL & not to be routed through bank.

- a) Commercial Invoice in triplicate
- b) Delivery Challan in triplicate whichever is applicable
- c) Guarantee certificate.
- d) Lorry Way Bill (Original + Two copies)

BHEL
M. THANGARAJ, M.I.E., M.B.A., M.S.
Manager / Purchase
Pipes, Electrodes Transport Bills
ICT Products & AMC
BHEL / Piping Centre
T. Nagar, Chennai - 600 017

VENDOR



BHEL/PIPING CENTRE/MOU/IS 3589 PIPES

- e) Site Ack. Lorry Way Bill (Original + Two Copies)
- f) Quality documents (as indicated above)
- g) ED gate pass with a confirmation that the duplicate for transporter is sent with the goods.

Page | 10

Soft copy of Invoice and LR should be sent immediately after despatch by e-mail. Hard copy should be sent subsequently at the earliest possible time.

THE MOU IS ONLY INDICATIVE AND NOT EXHAUSTIVE. BIDDERS SHOULD GO THROUGH THE ENQUIRIES FOR ANY SPECIAL/ADDITIONAL REQUIREMENTS APART FROM THE MOU TERMS AND CONDITIONS.

M. THANGABALI, M.I.E., M.B.A., M.S.
Manager / Purchase
Pipes, Electrodes Transport Bills
ICT Products & AMC
BHEL / Piping Centre
T. Nagar, Chennai - 600 017

VENDOR



ANNEXURE 1 – REVERSE AUCTION(RA) TERMS AND CONDITIONS

1. BHEL reserves the right to go for Reverse Auction (RA) instead of opening the sealed envelope price bid, submitted by the bidder. This will be decided after techno-commercial evaluation. All bidders to give their acceptance for participation in RA. Non-acceptance to participate in RA may result in non-consideration of their bids, in case BHEL decides to go for RA.
2. In case BHEL decides to go for Reverse Auction, only those bidders who have given their acceptance to participate in RA will be allowed to participate in the Reverse Auction. Those bidders who have given their acceptance to participate in Reverse Auction will have to necessarily submit „online sealed bid“ in the Reverse Auction. Non-submission of „online sealed bid“ by the bidder will be considered as tampering of the tender process and will invite action by BHEL as per extant guidelines in vogue.
3. In case BHEL decides not to conduct RA, the envelope sealed price bids of all techno commercially qualified bidders shall be opened. Hence, it is advised to all vendors to submit the envelope price bids/e-price bids correctly.
4. In case of reverse auction, BHEL will engage the services of a service provider who will provide all necessary training and assistance before commencement of on line bidding on internet. Business rules like event date, time etc., also will be communicated through service provider for compliance.
5. BHEL will provide the calculation sheet (e.g EXCEL sheet) which will help to arrive at “Total cost to BHEL like Packing & forwarding charges, Taxes and Duties, Freight charges, Insurance, Service Tax for Service and loading Factors with others Commercial terms & conditions for each of the vendor to enable them to fill-in the price and keep it ready for keying in during the Auction.
6. This excel sheet(without any rates) must be acknowledged and sent along with the compliance form to the service provider.
7. In order to have serious bidding in RA, the H1 bidder (whose quote is highest in online sealed bid) will not be allowed to participate in further RA process. Wherever more than one bidder is H1, all H1 bidders will not be allowed to participate in further RA.

M. THANGARAJ, M.I.E., M.B.A., M.S.
Manager / Purchase
Pipes, Electrodes Transport Bills
ICT Products & AMC
BHEL / Piping Centre
T Nagar, Chennai - 600 017

VENDOR



8. If the lowest "online sealed bid" is the starting price, then the lowest bidder in online sealed bid shall be shown as current L1 automatically by the system and no acceptance of that price is required.
9. BHEL reserves the right to treat RA as failed in cases, where no bidder accepts the start price. In such cases, envelope price bids/e-price bids shall be opened and processed accordingly. "Online sealed bid" prices will not be considered.
10. Time extension of 15 minutes based on the request from the bidder (maximum one request per bidder) on account of inability to bid can be given, provided such requests come before five minutes of auction closing time.
11. The lowest bidder has to Fax the duly signed Filled-in prescribed format as provided on case-to-case basis to BHEL through Service Provider immediately at the end of RA without fail.
12. Any variation between the on-line bid value and the signed document will be considered as sabotaging the tender process and will invite disqualification of vendor to conduct business with BHEL as per prevailing procedure.
13. After emerging as L1, if the vendor backs out from delivering at the entered prices, appropriate action would be taken against the vendor as per BHEL procedures. Hence, it is advised to take utmost care and ensure correct bidding during the Reverse Auction.

M. THANGARAJ, M.I.E., M.B.A., M.S.
Manager / Purchase
Pipes, Electrodes Transport Bills
ICT Products & AMC
BHEL / Piping Centre
T. Nagar, Chennai - 600 017

VENDOR



1.0 SCOPE

- 1.1 This Technical Delivery Conditions specify the requirements in addition to IS:3589 for electrically welded (ERW \ SAW) steel pipes.
- 1.2 The pipes are intended for water services (under Non-IBR Piping system only).
- 1.3 The pipes shall conform to the size, grade and quantity as specified in the purchase order.

2.0 MATERIAL

- 2.1 The plates / coils used for pipe shall meet the requirements as per IS: 3589 Grade Fe 410 MPa including mechanical test requirements.

3.0 DIMENSIONAL TOLERANCES

- 3.1 The tolerances limits are:

- a) OD:- Upto NB 1600 mm: ± 4 mm; Above NB 1600 mm: ± 6 mm
- b) Thickness:- Upto 14mm : +1.3mm / -0.8mm; Above 14 mm : +1.4mm / - 0.8mm.
- c) Ovality (Difference between major and minor inside diameter): 0.5% maximum
- d) Squareness of ends: The ends of pipe section shall not vary by more than 3mm at any point from a true plane perpendicular to the axis of the pipe and passing through the center of the pipe at the end.
- e) Length and quantity tolerance as per P.O.

- 3.2 Other tolerances shall be as per IS: 3589

4.0 MANUFACTURING

- 4.1 The pipe shall be of longitudinally welded or spirally welded as indicated in the P.O.
- 4.2 The ends shall be edge prepared as indicated in the purchase order.
- 4.3 Circumferential seams shall be minimum 1500 mm apart from each other and from ends.
- 4.4 All pipes shall be completely finished and free from surface, sub surface defects such as pits, cracks, weld spatters & laminations etc..

5.0 NDE

- 5.1 For Pipe dia less than 1000mm:- 100 % Hydro test on each pipe + Radiography test for 100mm weld length at both the ends for 10% of the pipes.
- 5.2 For Pipe dia 1000 mm & above :-The NDT for each pipe shall be done by any one of the following options. The vendor shall indicate their choice in the offer.
 - a) 100 % Hydro test along with Radiography test for 100mm weld length on both the ends of each pipe.
 - b) 100 % Ultrasonic test + 10 % Radiography test on weld length (including all T-joints and 100mm weld length at both the ends) for each pipe.
 - c) 100 % Radiography test on weld length of each pipe.
- 5.3 The Ultrasonic test / Radiography test shall be carried out as per ASME Sec-V and shall be accepted as per ASME B31.1 Cl:136.4.6 / Cl:136.4.5.

6.0 INSPECTION

- 6.1 All pipes shall be inspected by the vendor prior to BHEL / Customers' Inspection. BHEL or BHEL authorized inspector / Customer will select the pipes at random and carryout the inspection. The necessary Material Despatch Clearance Certificate is to be obtained by the vendor prior to the despatch of material.

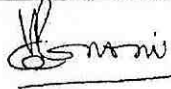
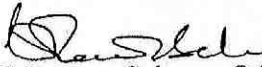
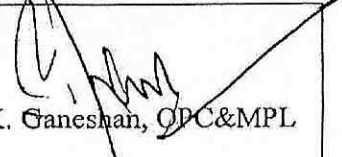
 G.Venkataramani, Engg&Quality	Approved by  G.Panneer Selvam, QA	 K. Ganesan, QPC&MPL
--	--	--

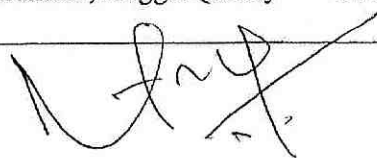



7.0 PAINTING AND PACKING

- 7.1 The pipes if dispatched to BHEL Stores shall be coated with resin type translucent rust preventive on the outside unless otherwise specified in the P.O. Pipes of diameter above NB 450 mm, shall be coated inside also.
- 7.2 The pipes if dispatched to project site directly shall be coated outside & inside as indicated in P.O.
- 7.3 In case of any special coating like PU, Glass Flake etc.. the vendor shall get BHEL approval for their QP and Procedure for application of coating.
- 7.4 Internal coating shall not be applied for 100mm length from each end to facilitate site joints.
- 7.5 Spiders are to be provided on both ends of the pipes as per the drawing indicated in the enquiry / Purchase Order.

8.0 MARKING

- 8.1 The pipes dispatched to **BHEL Stores** shall be **paint stencilled & hard punched** with the following details,
1) PO Number 2) Supplier's emblem/code 3) Size & Specification 4) Heat number
5) Pipe number 6) Inspector's seal
- 8.2 The pipes despatched directly to project site as **DTS**, the following details (furnished in the P.O. or separately) shall be **paint stencilled & hard punched** on both ends of the pipes in addition to the above.
> Work order No > DU No > Project name
> Quantity > Weight
- 8.3 For the pipe dia 1000mm and above marking shall be done on internal surface in the uncoated area (i.e) within 100mm from pipe ends. The hard punching shall be done at one end and paint stencilling at other end. In case of pipes of dia less than 1000mm the marking shall be done on outside surface.

9.0 CERTIFICATES

- 9.1 Three original test certificates typed in English shall be submitted along with the inspection report.
- 9.2 The test certificate shall furnish the following details.
- BHEL P.O Number & Amendment Number(if any)
 - BHEL P.O. Serial Number
 - Test Certificate number.
 - Specification, grade, size, quantity
 - Heat number of plate (or pipe number with traceability to heat number)
 - Chemical composition and Mechanical properties
 - Hydrostatic test, UT, RT reports as applicable.
 - Dimensional report
 - Painting details

Records of Revn:06 :- i) Para 3.1, 5.1, 7.1, 8.1, 8.2 & 9.2 are revised
ii) Para 5.2, 5.3, 7.2, 7.3, 7.4 & 8.3 are added.

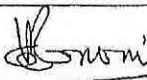
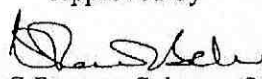
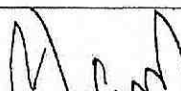
 G.Venkataramani, Engg&Quality	Approved by  G.Panneer Selvam, QA	 K.-Ganesan, OPC&MPL
--	--	--

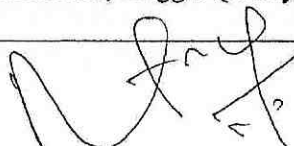

Handwritten signature

REV	DATE	ALTERED
		APPROVED

ALL DIMENSIONS ARE IN MILLIMETRES

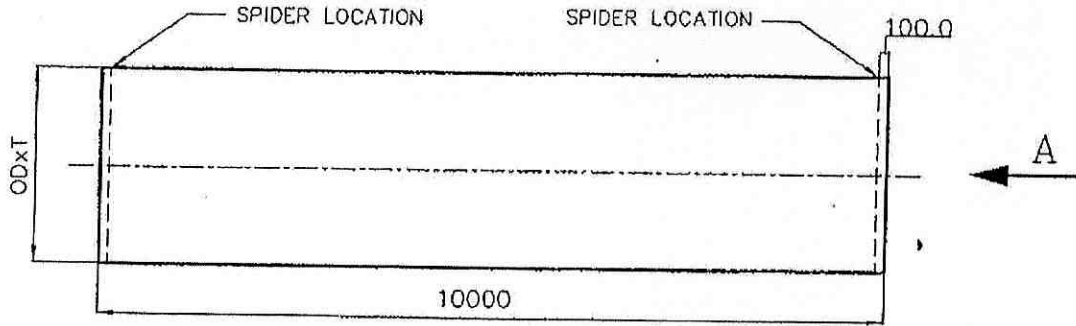

SPIRAL/LONGITUDINAL WELDED PIPE
(2 LOCATIONS IN 10 MTR. PIPE)

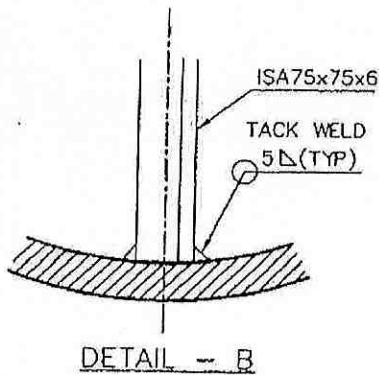
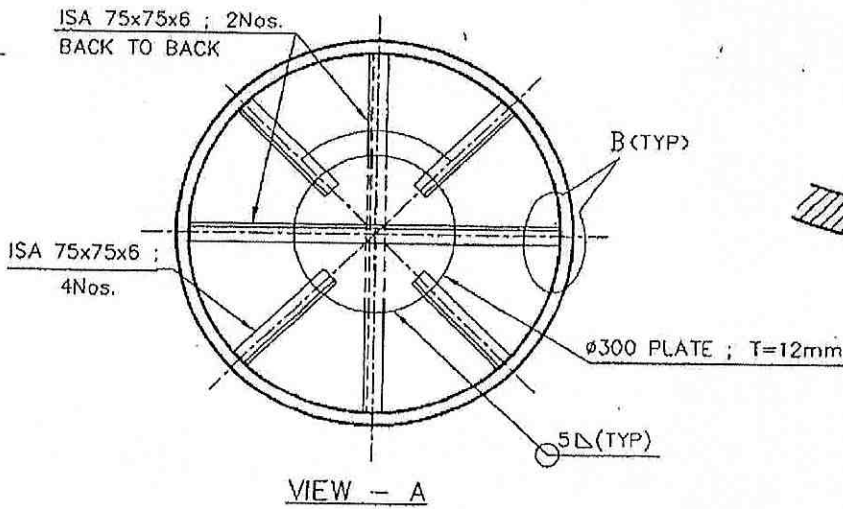

DETAIL - B

		BHARAT HEAVY ELECTRICALS LIMITED PIPING CENTRE CHENNAI 600 017		DRN C.KUMAR	NAME C.KUMAR	SIGN 	DATE 11.04.08	NO. OF VAR
DEPT CODE	GRADE OF UNFOL DIM C / M / F		SCALE N.T.S	WEIGHT (KG).	REF. TO ASSY./OLD DRG.	ITEM NO.	NO. OF ITMS	
TITLE SPIDER ARRANGEMENT FOR FOR PIPE DIA > 1000				CARD CODE U 01	DRAWING NO. 4-80-999-93078		REV 00	

Size A4

VIEW DRAWING THIS DRAWING IS THE PROPERTY OF BHARAT HEAVY ELECTRICALS LTD. It must not be used directly or indirectly in any way detrimental to the interest of the company.