

TENDER SPECIFICATION

NO: BHE/PW/PUR/MADT2-ELE/1501

FOR HANDLING AT SITE STORES/STORAGE YARD, TRANSPORTATION TO SITE OF WORK, COMPLETE ERECTION,CALIBRATION, TESTING, COMMISSIONING ,FINAL PAINTING AND HANDING OVER OF CABLING PACKAGE, JUNCTION BOXES,MCC,ACP,DAVR,ELECTRO STATIC PRECIPITATOR,SOOT BLOWER SYSTEM,AND ASSOCIATED EQUIPMENTS FOR 2X660 MW NTPC MAUDA TPP PHASE-II (UNIT 3&4).

AT
NTPC MAUDA SUPER THERMAL POWER PROJECT

VOLUME – I

CONSISTING OF:

- Notice Inviting Tender,
- Volume-IA : Technical Conditions of Contract,
- Volume-IB : Special conditions of Contract,
- Volume-IC : General conditions of Contract
- Volume-ID : Forms & Procedures



Bharat Heavy Electricals Limited
(A Government of India Undertaking)
Power Sector - Western Region
345-Kingsway, Nagpur-440001

Volume No	Description	Hosted in website BHEL.com as files titled
NIL	Tender Specification Issue Details	(Part of <u>Vol-IA-1501</u>)
NIL	Notice Inviting Tender	(Part of <u>Vol-IA-1501</u>)
I-A	Technical Conditions of Contract	Vol-IA-1501
I-B	Special Conditions of Contract	Vol-IBCD-1501
I-C	General Conditions of Contract	(Part of Vol-IBCD-1501)
I-D	Forms & Procedures	(Part of Vol-IBCD-1501)
II	Price Bid Specification	Vol-II-1501

TENDER SPECIFICATION

NO: BHE/PW/PUR/MADT2-ELE/1501

FOR HANDLING AT SITE STORES/STORAGE YARD, TRANSPORTATION TO SITE OF WORK, COMPLETE ERECTION,CALIBRATION, TESTING, COMMISSIONING ,FINAL PAINTING AND HANDING OVER OF CABLING PACKAGE, JUNCTION BOXES,MCC,ACP,DAVR,ELECTRO STATIC PRECIPITATOR,SOOT BLOWER SYSTEM,AND ASSOCIATED EQUIPMENTS FOR 2X660 MW NTPC MAUDA TPP PHASE-II (UNIT 3&4).

AT
NTPC MAUDA SUPER THERMAL POWER PROJECT

EARNEST MONEY DEPOSIT: Refer Notice Inviting Tender

LAST DATE FOR Refer Notice Inviting Tender
TENDER SUBMISSION .

THESE TENDER SPECIFICATION DOCUMENTS CONTAINING VOLUME-I AND VOLUME- II ARE ISSUED TO:

M/s.

.....

PLEASE NOTE:
THESE TENDER SPECS DOCUMENTS ARE NOT TRANSFERABLE.

For Bharat Heavy Electricals Limited

AGM (Purchase)
Place: Nagpur
Date :

1501

NOTICE INVITING TENDER

Bharat Heavy Electricals Limited

Ref: BHE/PW/PUR/MADT2-ELE/1501

Date: 22/07/2015

NOTICE INVITING TENDER (NIT)

**NOTE: BIDDER MAY DOWNLOAD FROM WEB SITES
OR
PURCHASE TENDERS FROM THIS OFFICE ALSO**

To

Dear Sir/Madam

Sub : NOTICE INVITING TENDER

Sealed offers in two part bid system are invited from reputed & experienced bidders (meeting [PRE QUALIFICATION CRITERIA](#) as mentioned in Annexure-I) for the subject job by the undersigned on the behalf of BHARAT HEAVY ELECTRICALS LIMITED as per the tender document. Following points relevant to the tender may please be noted and complied with.

1.0 Salient Features of NIT

SL NO	ISSUE	DESCRIPTION
i	TENDER NUMBER	BHE/PW/PUR/MADT2-ELE/1501
ii	Broad Scope of job	HANDLING AT SITE STORES/STORAGE YARD, TRANSPORTATION TO SITE OF WORK, COMPLETE ERECTION,CALIBRATION, TESTING, COMMISSIONING ,FINAL PAINTING AND HANDING OVER OF CABLING PACKAGE, JUNCTION BOXES,MCC,ACP,DAVR,ELECTRO STATIC PRECIPITATOR,SOOT BLOWER SYSTEM,AND ASSOCIATED EQUIPMENTS FOR 2X660 MW NTPC MAUDA TPP PHASE-II (UNIT 3&4) AT NTPC MAUDA SUPER THERMAL POWER PROJECT.
iii	DETAILS OF TENDER DOCUMENT	
a	Volume-IA	<i>Technical Conditions of Contract (TCC) consisting of Scope of work, Technical Specification, Drawings, Procedures, Bill of Quantities, Terms of payment, etc</i>
b	Volume-IB	<i>Special Conditions of Contract (SCC)</i>

Applicable

Applicable

BHEL PSWR

Notice Inviting Tender

Tender Specification No : BHE/PW/PUR/MADT2-ELE/1501

Page 6 of 95

c	Volume-IC	<i>General Conditions of Contract (GCC)</i>	<i>Applicable</i>
d	Volume-ID	<i>Forms and Procedures</i>	
e	Volume-II	<i>Price Schedule (Absolute value).</i>	<i>Applicable</i>
iv	Issue of Tender Documents	<p>1. <u>Sale from BHEL PS Regional office at :</u> Start : 22/07/2015 , Closes: 11/08/2015 , Time : 16.00 Hrs</p> <p>2. From BHEL website (www.bhel.com) Tender documents will be available for downloading from website till due date of submission</p>	<i>Applicable</i>
v	DUE DATE & TIME OF OFFER SUBMISSION	<p>Date : 12/08/2015, Time 15.00 Hrs Place : <u>BHEL PS Regional office at :Nagpur</u></p> <p>Tenders being submitted through representative shall be submitted at dispatch section of PSWR HQ Office after making entry/registration at the reception. For any assistance on the matter kindly contact following officials:</p> <ul style="list-style-type: none"> • Pratih Gee Varghese / Sr Engineer (Purchase) • Shivkesh Meena / Engineer (Purchase) 	<i>Applicable</i>
vi	OPENING OF TENDER	<p>1 hours after the latest due date and time of Offer submission</p> <p>Notes: (1) In case the due date of opening of tender becomes a non-working day, then the due date & time of offer submission and opening of tenders get extended to the next working day. (2) Bidder may depute representative to witness the opening of tender</p>	<i>Applicable</i>
vii	EMD AMOUNT	<i>Rs 2,00,000/- (Rupees Two Lakhs Only)</i>	<i>Applicable</i>
viii	COST OF TENDER	<i>Rs 2000/-. (Rupees Two Thousand Only)</i>	<i>Applicable</i>
ix	LAST DATE FOR SEEKING CLARIFICATION	<p><i>Five days before the due date of offer submission.</i></p> <p><i>Along with soft version also, addressing to undersigned & to others as per contact address given below</i></p>	<i>Applicable</i>
x	SCHEDULE OF Pre Bid	<i>Date :</i>	<i>Not applicable.</i>

	Discussion (PBD)		
xi	INTEGRITY PACT & DETAILS OF INDEPENDENT EXTERNAL MONITOR (IEM)		<i>Not Applicable</i>
xii	Latest updates	Latest updates on the important dates, Amendments, Correspondences, Corrigenda, Clarifications, Changes, Errata, Modifications, Revisions, etc to Tender Specifications will be hosted in BHEL webpage (www.bhel.com -->Tender Notifications →View Corrigendums) and not in the newspapers. Bidders to keep themselves updated with all such information	

- 2.0 The offer shall be submitted as per the instructions of tender document and as detailed in this NIT. Bidders to note specifically that all pages of tender document, including these NIT pages of this particular tender together with subsequent correspondences shall be submitted by them, duly signed & stamped on each page, as part of offer. Rates/Price including discounts/rebates, if any, mentioned anywhere/in any form in the techno-commercial offer other than the Price Bid, shall not be entertained.
- 3.0 Unless specifically stated otherwise, bidder shall remit cost of tender and courier charges if applicable, in the form of Demand Draft drawn in favour of Bharat Heavy Electricals Ltd, payable at Power Sector Regional HQ at Nagpur issuing the Tender, along with techno-commercial offer. Bidder may also choose to deposit the Tender document cost by cash at the Cash Office as stated above against sl no iv of 1, on any working day; and in such case copy of Cash receipt is to be enclosed with the Techno Commercial offer. Sale of tender Documents shall not take place on National Holidays, holidays declared by Central or State Governments and BHEL PS HQ at Nagpur, Sundays and second/ last Saturdays
- 4.0 Unless specifically stated otherwise, bidder shall deposit EMD through Demand Draft/Pay Order in favour of Bharat Heavy Electricals Ltd, payable at Nagpur. For other details and for 'One Time EMD' please refer General Conditions of Contract.
- 5.0 **Procedure for Submission of Tenders:** The Tenderers must submit their Tenders to Officer inviting Tender, as detailed below:

BHEL PSWR**Notice Inviting Tender****Tender Specification No : BHE/PW/PUR/MADT2-ELE/1501****Page 8 of 95**

- PART-I consisting of 'PART-I A (Techno Commercial Bid)' & 'PART-I B (EMD/COST of TENDER)' in two separate sealed and superscribed envelopes (ENVELOPE-I & ENVELOPE-II)
- PART-II (Price Bid) – in sealed and superscribed envelope (ENVELOPE-III)
- One set of tender documents shall be retained by the bidder for their reference

6.0 The contents for ENVELOPES and the superscription for each sealed cover/Envelope are as given below. **(All pages to be signed and stamped)**

Sl no	Description	Remarks
	Part-I A	
	<p><u>ENVELOPE – I superscribed as :</u> PART-I (TECHNO COMMERCIAL BID) TENDER NO : NAME OF WORK : PROJECT: DUE DATE OF SUBMISSION:</p> <p><u>CONTAINING THE FOLLOWING:-</u></p>	
i.	Covering letter/Offer forwarding letter of Tenderer.	
ii.	<p>Duly filled-in 'No Deviation Certificate' as per prescribed format to be placed after document under sl no (i) above.</p> <p><u>Note:</u></p> <p>a. In case of any deviation, the same should be submitted separately for technical & commercial parts, indicating respective clauses of tender against which deviation is taken by bidder. The list of such deviation shall be placed after document under sl no (i) above. It shall be specifically noted that deviation recorded elsewhere shall not be entertained.</p> <p>b. BHEL reserves the right to accept/reject the deviations without assigning any reasons, and BHEL decision is final and binding.</p> <p>i). In case of acceptance of the deviations, appropriate loading shall be done by BHEL</p> <p>ii). In case of unacceptable deviations, BHEL reserves the right to reject the tender</p>	
iii.	<p>Supporting documents/ annexure/ schedules/ drawing etc as required in line with Pre-Qualification criteria.</p> <p>It shall be specifically noted that all documents as per above</p>	

	shall be indexed properly and credential certificates issued by clients shall distinctly bear the name of organization, contact ph no, FAX no, etc.	
iv.	All Amendments/Correspondences/Corrigenda/Clarifications/Changes/ Errata etc pertinent to this NIT.	
v.	Integrity Pact Agreement (Duly signed by the authorized signatory)	If applicable
vi.	Duly filled-in annexures, formats etc as required under this Tender Specification/NIT	
vii.	Notice inviting Tender (NIT)	
viii.	Volume – I A : <u>Technical</u> Conditions of Contract (TCC) consisting of Scope of work, Technical Specification, Drawings, Procedures, Bill of Quantities, Terms of payment, etc	
ix.	Volume – I B : Special Conditions of Contract (SCC)	
x.	Volume – I C : General Conditions of Contract (GCC)	
xi.	Volume – I D : Forms & Procedures	
xii.	Volume – II (UNPRICED – without disclosing rates/price, but mentioning only ‘QUOTED’ or ‘UNQUOTED’ against each item	
xiii.	Any other details preferred by bidder with proper indexing.	

	PART-I B	
	<p>ENVELOPE – II superscribed as: PART-I (EMD/COST of TENDER) TENDER NO : NAME OF WORK : PROJECT: DUE DATE OF SUBMISSION:</p> <p>CONTAINING THE FOLLOWING:-</p>	
i.	<p>1. Earnest Money Deposit (EMD) in the form as indicated in this Tender</p> <p align="center">OR</p> <p>Documentary evidence for ‘One Time EMD’ with the Power Sector Region of BHEL floating the Tender</p> <p>2. Cost of Tender (Demand Draft or copy of Cash Receipt as the case may be)</p>	

	PART-II	
--	----------------	--

	PRICE BID consisting of the following shall be enclosed	
	<p>ENVELOPE-III superscribed as: PART-II (PRICE BID) TENDER NO : NAME OF WORK : PROJECT: DUE DATE OF SUBMISSION:</p> <p>CONTAINING THE FOLLOWING</p>	
i	Covering letter/Offer forwarding letter of Tenderer enclosed in Part-I	
ii	Volume II – PRICE BID (Duly Filled in Schedule of Rates – rate/price to be entered in words as well as figures)	

	OUTER COVER	
	<p>ENVELOPE-IV (MAIN ENVELOPE / OUTER ENVELOPE) superscribed as: TECHNO-COMMERCIAL BID, PRICE BID & EMD TENDER NO: NAME OF WORK: PROJECT: DUE DATE OF SUBMISSION:</p> <p>CONTAINING THE FOLLOWING:</p>	
i	<ul style="list-style-type: none"> ○ Envelopes I ○ Envelopes II ○ Envelopes III 	

SPECIAL NOTE : All documents/ annexures submitted with the offer shall be properly annexed and placed in respective places of the offer as per enclosure list mentioned in the covering letter. BHEL shall not be responsible for any missing documents.

- 7.0 Deviation with respect to tender clauses and additional clauses/suggestions in Techno-commercial bid / Price bid shall NOT be considered by BHEL. Bidders are requested to positively comply with the same.
- 8.0 BHEL reserves the right to accept or reject any or all Offers without assigning any reasons thereof. BHEL also reserves the right to cancel the Tender wholly or partly without assigning any reason thereof. Also BHEL

shall not entertain any correspondence from bidders in this matter (except for the refund of EMD).

9.0 Assessment of Capacity of Bidders:

Bidders capacity for executing the job under tender shall be assessed 'LOAD' wise and 'PERFORMANCE' wise as per the following:

- I. **LOAD:** Load takes into consideration **ALL** the contracts of the Bidder under execution with BHEL Regions, irrespective of whether they are similar to the tendered scope or not. The 'Load' is the sum of the unit wise identified packages (refer Table-1) for contracts with BHEL Regions. The cut off month for reckoning 'Load' shall be the month, two (2) months preceding the month corresponding to the 'latest date of bid submission', in the following manner:

(Note: For example if latest bid submission is in Aug 2011, then the 'load' shall be calculated upto and inclusive of June 2011)

- i). Total number of Packages

Total number of Packages in hand = P

Where

- 'P' is the sum of all unit wise identified packages under execution with BHEL Regions as of the cut off month defined above, including packages yet to be commenced, excepting packages which are on HOLD due to reasons not attributable to Bidder..

- II. **PERFORMANCE:** Here 'Monthly Performance' of the bidder for all the packages (**under execution/** executed during the 'Period of Assessment' in all the Power Sector Regions of BHEL) **SIMILAR** to the packages covered under the tendered scope, excepting packages not commenced shall be taken into consideration. The 'Period of Assessment' shall be 6 months preceding the cut off month. The cut off month for reckoning 'Period of Assessment' shall be the month two (2) months preceding the month corresponding to the 'latest date of bid submission', in the following manner:

(Note: For example if 'latest date of bid submission' is in Aug 2011, then the 'performance' shall be assessed for a 6 month period

upto and inclusive of June 2011, for all the unit wise identified packages (refer Table I)

- i). Calculation of Overall 'Performance Rating' for 'similar Package/Packages' for the tendered scope under execution at Power Sector Regions for the 'Period of Assessment':

This shall be obtained by summing up the 'Monthly Performance Evaluation' scores obtained by the bidder in all Regions for all the similar Package/packages', divided by the total number of Package months for which evaluation should have been done, as per procedure below:

- a) $P_1, P_2, P_3, P_4, P_5, \dots, P_N$ etc be the packages (**under execution**/ executed during the 'Period of Assessment' in all Regions) **SIMILAR** to the packages covered under the tendered scope, excepting packages not commenced. Total number of similar packages for all Regions = P_T (ie $P_T = P_1 + P_2 + P_3 + P_4 + \dots + P_N$)

- b) Number of Months ' T_1 ' for which 'Monthly Performance Evaluation' as per relevant formats, should have been done in the 'Period of Assessment' for the corresponding similar package P_1 . Similarly T_2 for package P_2 , T_3 for package P_3 , etc for the tendered scope. Now calculate cumulative total months ' T_T ' for total similar Packages ' P_T ' for all Regions (i.e $T_T = T_1 + T_2 + T_3 + T_4 + \dots + T_N$)

- c) Sum ' S_1 ' of 'Monthly Performance Evaluation' Scores ($S_{1-1}, S_{1-2}, S_{1-3}, S_{1-4}, S_{1-5}, \dots, S_{1-N}$) for similar package P_1 , for the 'period of assessment' ' T_1 ' (i.e $S_1 = S_{1-1} + S_{1-2} + S_{1-3} + S_{1-4} + S_{1-5} + \dots + S_{1-N}$). Similarly S_2 for package P_2 for period T_2 , S_3 for package P_3 for period T_3 , etc for the tendered scope for all Regions. Now calculate cumulative sum ' S_T ' of 'Monthly Performance Evaluation' Scores for total similar Packages ' P_T ' for all Regions (i.e ' $S_T = S_1 + S_2 + S_3 + S_4 + S_5 + \dots + S_N$).

- d) **Overall Performance Rating ' R_{BHEL} ' for the similar Package/Packages (under execution/ executed during the 'Period of Assessment') in all the Power Sector Regions of BHEL):**

Aggregate of Performance scores for all similar packages in all the Regions

= -----

Aggregate of months for each of the similar package for which performance should have been evaluated in all the Regions

$$= \frac{S_T}{T_T}$$

e) Bidders to note that the risk of non evaluation or non availability of the ‘Monthly Performance Evaluation’ reports as per relevant formats is to be borne by the Bidder

f) Table showing methodology for calculating ‘a’, ‘b’ and ‘c’ above

Sl n o	Item Description	Details for all Regions							Total
		(iii)	(iv)	(v)	(vi)	(vii)	(viii)	(ix)	
1	Similar Packages for all Regions → (under execution/ executed during period of assessment)	P ₁	P ₂	P ₃	P ₄	P ₅	...	P _N	Total No of similar packages for all Regions = P_T ie Sum (Σ) of columns (iii) to (ix)
2	Number of Months for which ‘Monthly Performance Evaluation’ as per relevant formats should have been done in the ‘period of assessment for corresponding similar Package (as in row 1)	T ₁	T ₂	T ₃	T ₄	T ₅	...	T _N	Sum (Σ) of columns (iii) to (ix) = T_T
3	Monthly performance scores for the	S ₁₋₁ , S ₁₋₂ , S ₁₋₃	S ₂₋₁ , S ₂₋₂ , S ₂₋₃	S ₃₋₁ , S ₃₋₂ , S ₃₋₃	S ₄₋₁ , S ₄₋₂ , S ₄₋₃	S ₅₋₁ , S ₅₋₂ , S ₅₋₃	S _{N-1} , S _{N-2} , S _{N-3}	-----

	corresponding period (as in Row 2)	2, S ₁ - 3, S ₁ - 4, ... S ₁ -T ₁	S ₂₋₄ , ... S _{2-T2}	S ₃ - 3, S ₃ - 4, ... S _{3-T3}	S ₄ - 3, S ₄ - 4, ... S _{4-T4}	S ₅ - 3, S ₅ - 4, ... S _{5-T5}	S _{N-4} , ... S _N - T _N	
4	Sum of Monthly Performance scores of the corresponding Package for the corresponding period (as in row-3)	S ₁	S ₂	S ₃	S ₄	S ₅	...	S _N	Sum (Σ) of columns (iii) to (ix) = S_T

- ii) Calculation of Overall ‘Performance Rating’ (**R_{BHEL}**) in case ‘similar Package/Packages’ for the tendered scope ARE NOT AVAILABLE, during the ‘Period of Assessment’:

This shall be obtained by summing up the ‘Monthly Performance Evaluation’ scores obtained by the bidder in all Regions for ALL the packages, divided by the total number of Package months for which evaluation should have been done. ‘R_{BHEL}’ shall be calculated subject to availability of ‘performance scores’ for at least.6 ‘package months’ in the order of precedence below:

- a) ‘Period of Assessment.
- b) 12 months preceding the cut-off month
- c) 24 months preceding the cut-off month
- d) 36 months preceding the cut-off month

In case, R_{BHEL} cannot be calculated as above, then Bidder shall be treated as ‘NEW VENDOR’. Further eligibility and qualification of this bidder shall be as per definition of ‘NEW VENDOR’ described in ‘Explanatory Notes’

- iii) Factor “L” assigned based on Overall Performance Rating (R_{BHEL}) at Power Sector Regions,:

Sl no	Overall Performance Rating (R _{BHEL})	Corresponding value of ‘L’
1	=60	NA
2	> 60 and ≤ 65	0.4
3	> 65 and ≤ 70	0.35
4	> 70 and ≤ 75	0.25

5	> 75 and < 80	0.2
6	≥ 80	NA

III. 'Assessment of Capacity of Bidder':

'Assessment of Capacity of Bidder' is based on the Maximum number of packages for which a vendor is eligible, considering the performance scores of similar packages, as below:

Max number of packages $P_{Max} = (R_{BHEL} - 60)$ divided by corresponding value of 'L'
 i.e. $(R_{BHEL} - 60)/L$

Note:

- i. In case the value of P_{Max} results in a fraction, the value of P_{Max} is to be rounded off to next whole number
- ii. For $R_{BHEL} = 60$, $P_{Max} = '1'$
- iii. For $R_{BHEL} \geq 80$, there will be no upper limit on P_{Max}

The Bidder shall be considered 'Qualified' as per 'Assessment of Capacity of Bidder' for the subject Tender if $P \leq P_{Max}$
 (where P is calculated as per clause 9.I)

IV. Explanatory note:

- a) Similar package means Boiler or ESP or Piping or Turbine or Civil or Structure or Electrical or CI, etc at the individual level irrespective of rating of Plant, and irrespective of whether the subject tender is a single package or as part of combined/composite packages. Normally Boiler, ESP, Piping, Turbine, Electrical, CI, Civil, Structure, etc is considered individual level of package. For example in case the tendered scope is a Boiler Vertical Package comprising of Boiler, ESP and Power Cycle Piping (i.e the 'identified packages as per Table-1 below), the 'PERFORMANCE' part against sl no II above, needs to be evaluated considering all the identified packages (ie Boiler, ESP and Power Cycle Piping) and finally the Bidder's capacity to execute the tendered scope is assessed in line with III above
- b) Identified Packages (Unit wise)

Table-1

	Civil	Electrical & CI	Mechanical
	i). Enabling works	i). Electrical	i). Boiler & Aux (All types including CW Piping if applicable)
	ii). Pile and Pile Caps	ii). CI iii). Others (Elec & CI)	ii). Power Cycle

	<ul style="list-style-type: none"> ii). Civil Works including foundations v). Structural Steel Fabrication & Erection v). Chimney vi). Cooling Tower ii). Others (Civil) 		<ul style="list-style-type: none"> Piping/Critical Piping iii). LP Piping iv). ESP v). Steam Turbine Generator set & Aux vi). Gas Turbine Generator set & Aux vii). Hydro Turbine Generator set & Aux iii). Turbo Blower (including Steam Turbine) ix). Material Handling x). Material Management xi). Material Handling & Material Management xii). Others (Mechanical)
--	---	--	---

c) Bidders who have not been evaluated for at least six package months in the last 36 months in the online BHEL system for contractor performance evaluation in BHEL PS Regions, wef July'2010 shall be considered "NEW VENDOR".

A 'NEW VENDOR' shall be considered qualified subject to satisfying all other tender conditions

A 'NEW VENDOR' if awarded a job (of package/packages identified under this clause) shall be tagged as "FIRST TIMER" on the date of first LOI from BHEL.

The "FIRST TIMER" tag shall remain till execution of work for a period of not less than 09 months, from the commencement of work of first package

A Bidder shall not be eligible for the next job as long as the Bidder is tagged as "FIRST TIMER" excepting for the Tenders

which have been opened on or before the date of the bidder being tagged as 'FIRST TIMER'.

After removal of 'FIRST TIMER' tag, the Bidder shall be considered 'QUALIFIED' for the future tenders subject to satisfying all other tender conditions including 'Capacity Evaluation of Bidders'.

- d) In the unlikely event of all bidders shortlisted against Technical and Financial Qualification criteria not meeting the criteria on 'Assessment of Capacity of Bidders' detailed above, OR leads to a single tender response on applying the criteria of 'Assessment of Capacity of Bidders' or due to non-approval by Customer, then BHEL at its discretion reserves the right to consider the further processing of the Tender based on the **Overall Performance Rating 'R_{BHEL}'** only, starting from the upper band.
- e) 'Under execution' shall mean works in progress as per the following:
- i. up to Boiler Steam Blowing in case of Steam Generator and Auxiliaries
 - ii. upto Synchronisation in case of all other works excepting sl no (i) and (iii)
 - iii. Upto execution of at least 90% of anticipated contract value in case of Civil & Structures (unit wise), Enabling works and upto 90% of material unloading (in tonnage) as per the original contract in case of MM Package.

Note : BHEL at its discretion can extend (or reduce in exceptional cases in line with Contract conditions) the period defined against (i), (ii) and (iii) above, depending upon the balance scope of work to be completed.

- f) Performance evaluation in CL 9 above is applicable to Prime bidder and consortium partner (or Technical tie up partner) for their respective scope of work

10.0 Since the job shall be executed at site, bidders must visit site/ work area and study the job content, facilities available, availability of materials, prevailing site conditions including law & order situation, applicable

-
- wage structure, wage rules, etc before quoting for this tender. They may also consult this office before submitting their offers, for any clarifications regarding scope of work, facilities available at sites or on terms and conditions.
- 11.0 For any clarification on the tender document, the bidder may seek the same in writing or through e-mail, as per specified format, within the scheduled date for seeking clarification, from the office of the undersigned. BHEL shall not be responsible for receipt of queries after due date of seeking clarification due to postal delay or any other delays. Any clarification / query received after last date for seeking clarification may not be normally entertained by BHEL and no time extension will be given.
- 12.0 BHEL may decide holding of pre-bid discussion [PBD] with all intending bidders as per date indicated in the NIT. The bidder shall ensure participation for the same at the appointed time, date and place as may be decided by BHEL. Bidders shall plan their visit accordingly. The outcome of pre-bid discussion (PBD) shall also form part of tender.
- 13.0 In the event of any conflict between requirement of any clause of this specification/ documents/drawings/data sheets etc or requirements of different codes/standards specified, the same to be brought to the knowledge of BHEL in writing for clarification before due date of seeking clarification (whichever is applicable), otherwise, interpretation by BHEL shall prevail. Any typing error/missing pages/ other clerical errors in the tender documents, noticed must be pointed out before pre-bid meeting/submission of offer, else BHEL's interpretation shall prevail.
- 14.0 Unless specifically mentioned otherwise, bidder's quoted price shall deemed to be in compliance with tender including PBD.
- 15.0 Bidders shall submit Integrity Pact Agreement (Duly signed by authorized signatory who signs in the offer), **if applicable**, along with techno-commercial bid. This pact shall be considered as a preliminary qualification for further participation. **The names and other details of Independent External Monitor (IEM) for the subject tender is as given at point (1) above.**
- 16.0 The Bidder has to satisfy the Pre Qualifying Requirements stipulated for this Tender in order to be qualified. The Price Bids of only those bidders will be opened who will be qualified for the subject job on the basis of satisfying the Pre Qualification Criteria specified in this NIT as per Annexure-I (as applicable), past performance etc. and date of opening of

price bids shall be intimated to only such bidders. BHEL reserves the right not to consider offers of parties under HOLD.

17.0 In case BHEL decides on a 'Public Opening', the date & time of opening of the sealed PRICE BID shall be intimated to the qualified bidders and in such a case, bidder may depute one authorised representative to witness the price bid opening. BHEL reserves the right to open 'in-camera' the 'PRICE BID' of any or all Unsuccessful/Disqualified bidders under intimation to the respective bidders.

18.0 Validity of the offer shall be for **six months** from the latest due date of offer submission (including extension, if any) unless specified otherwise.

19.0 BHEL reserves the right to decide the successful bidder on the basis of Reverse Auction process. In such case all qualified bidders will be intimated regarding procedure/ modality for Reverse Auction process prior to Reverse Auction and price will be decided as per the rules for Reverse Auction. .

However, if reverse auction process is unsuccessful as defined in the RA rules/procedures, or for whatsoever reason, then the sealed 'PRICE BIDS' will be opened for deciding the successful bidder. BHEL's decision in this regard will be final and binding on bidder.

20.0 On submission of offer, further consideration will be subject to compliance to tender & qualifying requirement and customer's acceptance, as applicable.

21.0 In case the bidder is an "Indian Agent of Foreign Principals", 'Agency agreement has to be submitted along with Bid, detailing the role of the agent along with the terms of payment for agency commission in INR, along with supporting documents.

22.0 The bidders shall not enter into any undisclosed M.O.U. or any understanding amongst themselves with respect to tender.

23.0 Consortium Bidding (or Technical Tie up) shall be allowed only if specified in Pre Qualifying Requirement (PQR) criteria, and in such a case the following shall be complied with:

23.1 Prime Bidder and Consortium Partner or partners are required to enter into a consortium agreement with a validity period of six months initially. In case the consortium is awarded the contract, then the Consortium Agreement between the Prime Bidder and Consortium Partner or partners shall be extended till contractual completion period including extension periods if any applicable.

-
- 23.2 'Stand alone' bidder cannot become a **'Prime Bidder' or a Consortium bidder' or 'Technical Tie up bidder' in a consortium (or Technical Tie up) bidding.** Prime bidder shall neither be a consortium partner to other prime bidder nor take any other consortium partners. However, consortium partner may enter into consortium agreement with other prime bidders. In case of non compliance, consortium bids of such Prime bidders will be rejected.
- 23.3 Number of partners for a consortium Bidding (or Technical Tie up) shall be as specified in the PQR
- 23.4 Prime Bidder shall be as specified in the Pre Qualification Requirement, else the bidder who has the major share of work
- 23.5 In order to be qualified for the tender, Prime Bidder and Consortium partner or partners shall satisfy (i) the Technical 'Pre Qualifying Requirements' specified for the respective package, (ii) "Assessment of Capacity of Bidder" as specified in clause 9.0
- 23.6 Prime Bidder shall comply with additional 'Technical' criteria of PQR as defined in 'Explanatory Notes for the PQR'
- 23.7 Prime Bidder shall comply with all other Pre Qualifying criteria for the Tender unless otherwise specified
- 23.8 In case customer approval is required, then Prime Bidder and Consortium Partner or partners shall have to be individually approved by Customer for being considered for the tender.
- 23.9 Prime Bidder shall be responsible for the overall execution of the contract
- 23.10 In case of award of job, Performance shall be evaluated for Prime Bidder and Consortium Partner or partners for their respective scope of work(s) as per prescribed formats
- 23.11 In case the Consortium partner or partners back out, their SDs shall be encashed by BHEL. In such a case, other consortium partner or partners meeting the PQR have to be engaged by the Prime Bidder, and if not, the respective work will be withdrawn and executed on risk and cost basis of the Prime Bidder. The new consortium partner or partners shall submit fresh SDs as applicable.

-
- 23.12 In case the prime Bidder withdraws, the whole contract shall be considered cancelled and short closed.
- 23.13 After execution of work, the work experience shall be assigned to the Prime Bidder and the consortium partner or partners for their respective scope of work. After successful execution of two similar works with the same consortium partner or partners under direct orders of BHEL, the Prime Bidder shall be eligible for becoming a 'stand alone' bidder for similar works, subject to certification from BHEL about the active involvement of the Prime Bidder for satisfactory execution of the works.
- 23.14 The consortium partner shall submit SD equivalent to 2% of the total contract value in addition to the SD to be submitted by the prime Bidder for the total contract value. In case there are two consortium partners, then each partner shall submit SD equivalent to 1% of the total contract value in addition to the SD to be submitted by the prime Bidder for the total contract value.
- 23.15 In case of a Technical Tie up, all the clauses applicable for the Consortium partner shall be applicable for the Technical Tie up partner also
- 24.0 The bidder shall submit documents in support of possession of 'Qualifying Requirements' duly self-certified and stamped by the authorized signatory, indexed and properly linked in the format for PQR. In case BHEL requires any other documents/proofs, these shall be submitted immediately.
- 25.0 The bidder may have to produce original document for verification if so decided by BHEL.
- 26.0 Order of Precedence
In the event of any ambiguity or conflict between the Tender Documents, the order of precedence shall be in the order below:
- a. Amendments/Clarifications/Corrigenda/Errata etc issued in respect of the tender documents by BHEL
 - b. Notice Inviting Tender (NIT)
 - c. Price Bid
 - d. Technical Conditions of Contract (TCC)—Volume-1A
 - e. Special Conditions of Contract (SCC) —Volume-1B
 - f. General Conditions of Contract (GCC) —Volume-1C
 - g. Forms and Procedures —Volume-1D

It may please be noted that guidelines/rules in respect of suspension of business dealings', 'Vendor evaluation format', 'Quality, Safety & HSE guidelines', etc may undergo change from time to time and the latest one shall be followed.

for BHARAT HEAVY ELECTRICALS LTD

AGM Pur

Enclosure

01. Annexure-1: Pre Qualifying criteria.
02. Annexure-2: Check List.
03. Annexure-3: Important Information.
- 04 Other Tender documents as per this NIT.

ANNEXURE - 1

PRE QUALIFYING CRITERIA

JOB	HANDLING AT SITE STORES/STORAGE YARD, TRANSPORTATION TO SITE OF WORK, COMPLETE ERECTION,CALIBRATION, TESTING, COMMISSIONING ,FINAL PAINTING AND HANDING OVER OF CABLING PACKAGE, JUNCTION BOXES,MCC,ACP,DAVR,ELECTRO STATIC PRECIPITATOR,SOOT BLOWER SYSTEM,AND ASSOCIATED EQUIPMENTS FOR 2X660 MW NTPC MAUDA TPP PHASE-II (UNIT 3&4) AT NTPC MAUDA SUPER THERMAL POWER PROJECT.	
SI No	Tender Specification Number	Unit Number & Project
1	BHE/PW/PUR/MADT2-ELE/1501	660 MW U # 3 and U # 4

SL NO	PRE QUALIFICATION CRITERIA	Bidders claim in respect of fulfilling the PQR Criteria	
		Name and Description of qualifying criteria	Page no of supporting document. Bidder must fill up this column as per applicability
A	Submission of Integrity Pact duly signed (if applicable) (Note: To be submitted by Prime Bidder & Consortium/Technical Tie up partner jointly in case Consortium bidding is permitted, otherwise by the sole bidder)	Not APPLICABLE	
B	Technical Bidder must meet B.1 in the last seven (7) years as on latest date of bid submission:- B.1) B.1.1) Executed Electrical work of value not less than Rs. 277.60 Lakhs, against single work order consisting of Power transformer of at least 1 MVA rating. OR B.1.2) Executed two Electrical works of value not less than Rs. 173.50 Lakhs each, against maximum two work orders and	APPLICABLE	

	<p>each work orders consisting of Power transformer of at least 1 MVA rating.</p> <p align="center">OR</p> <p>B.1.3) Executed three Electrical works of value not less than Rs. 138.80 Lakhs each, against maximum three work each work orders consisting of Power transformer of at least 1 MVA rating.</p>		
C-1	<p><u>Financial TURNOVER</u> Bidders must have achieved an average annual financial turnover (audited) of Rs 104.10 Lakhs or more over last three Financial Years (FY) i.e. 2012-2013, 2013-14, 2014-15 OR 2011-2012, 2012-2013, 2013-14 if Annual Accounts for FY 2014-15 are not audited.</p>	APPLICABLE	
C-2	<p><u>NETWORTH</u> (only in case of Companies) Net worth of the Bidder based on the latest Audited Accounts as furnished for 'C-1' above should be positive.</p>	APPLICABLE	
C-3	<p><u>PROFIT</u> Bidder must have earned cash profit in any one of the three Financial Years as applicable in the last three Financial Years defined in 'C-1' above based on latest Audited Accounts.</p>	APPLICABLE	
D	<p>Assessment of Capacity of Bidder to execute the work as per sl no 9 of NIT (if applicable)</p>	APPLICABLE	By BHEL
E	<p>Approval of Customer (if applicable)</p> <p>Note: Names of bidders (including consortium/Technical Tie up partners in case consortium bidding is permitted) who stand qualified after compliance of criteria A to D shall be forwarded to customer for their approval.</p>	Not APPLICABLE	BY BHEL
F	<p>Price Bid Opening</p> <p>Note: Price Bids of only those bidders shall be opened who stand qualified after compliance of criteria A to E</p>	APPLICABLE	BY BHEL

G	Technical Tie up criteria (if applicable)	Not applicable	
	<p><u>Explanatory Notes for the PQR (unless otherwise specified in the PQR):</u></p> <ol style="list-style-type: none"> 1. Bidder to submit Audited Balance Sheet and Profit and Loss Account for the respective years as indicated against C-1 above along with all annexures 2. In case audited Financial statements have not been submitted for all the three years as indicated against C-1 above, then the applicable audited statements submitted by the bidders against the requisite three years, will be averaged for three years i.e total divided by three. 3. C-2:-NETWORTH : Shall be calculated based on the latest Audited Accounts as furnished for C-1 above. Net worth = Paid up share capital + Reserves. (Net worth is required to be evaluated in case of companies) 4. C-3:- PROFIT : shall be NET profit (PAT + Non cash expenditure viz depreciation) earned during any one of the three financial years as in C-1 above 5. 'Additional' Criteria in respect of 'Technical' criteria of PQR (as in 'B' above) for Civil, Electrical, CI, unless otherwise specified:- <ol style="list-style-type: none"> 1. Bidder should have executed similar work of any one of the following: <ol style="list-style-type: none"> a. One (1) work of value not less than Rs XXX <li align="center">OR b. Two (2) works of not less than Rs YYY <li align="center">OR c. Three (3) works of not less than Rs ZZZ (Value XXX, YYY, ZZZ shall be as indicated by BHEL) 2. 'Similar' work for criteria 5 above means <ol style="list-style-type: none"> a. Civil or Structures or Civil & Structures or Chimney respectively as applicable to the tendered scope in respect of 'CIVIL' Works b. Electrical works in respect of 'ELECTRICAL' c. CI works in respect of 'CI' Works d. Material Handling and/or Management works in respect of 'MM' works 6. Time period for achievement of the 'Technical' criteria of PQR (as in 'B' above) will be the last 7 years ending on the 'latest date' of Bid submission 7. 'EXECUTED' means the Vendor should have achieved the criteria specified in the Technical criteria of PQR (as in 'B' above) even if the Contract has not been completed or closed 8. In case the experience/PO/WO certificate enclosed by bidders do not have separate break up prices for the E&C portion of Electrical and CI Works, (i.e. the certificates enclosed are for composite order for supply and erection of Electrical & CI and other works if any), then value of Erection and Commissioning for the Electrical & CI portion shall be considered as 15% of the supply & erection of Electrical & CI, unless otherwise specifically indicated in the PQR. 9. The value of work (Experience submitted against PQR B) shall be updated as per the PVC indices for "All India Avg. Consumer Price Index for Industrial Workers" with base month as date of execution (completion of contract/work) and indexed upto two months prior to bid opening Month. 		

BIDDER SHALL SUBMIT ABOVE PRE-QUALIFICATION CRITERIA FORMAT, DULY FILLED-IN, SPECIFYING RESPECTIVE ANNEXURE NUMBER AGAINST EACH CRITERIA AND FURNISH RELEVANT DOCUMENT IN THE RESPECTIVE ANNEXURES IN THEIR OFFER.

BHEL PSWR**Notice Inviting Tender****Tender Specification No : BHE/PW/PUR/MADT2-ELE/1501****Page 26 of 95****Bidder's Response to BHEL TECHNICAL PQR (WHICHEVER IS APPLICABLE)**

PQR No	Pre-Qualifying Requirement	Credentials based on which bidder is claiming PQR	Reference of the documents	Page No
B.1	<p>Bidder must meet B.1 in the last seven (7) years as on latest date of bid submission:-</p> <p>B.1)</p> <p>B.1.1) Executed Electrical work of value not less than Rs. 277.60 Lakhs, against single work order consisting of Power transformer of at least 1 MVA rating.</p> <p style="text-align: center;">OR</p> <p>B.1.2) Executed two Electrical works of value not less than Rs. 173.50 Lakhs each, against maximum two work orders and each work orders consisting of Power transformer of at least 1 MVA rating.</p> <p style="text-align: center;">OR</p> <p>B.1.3) Executed three Electrical works of value not less than Rs. 138.80 Lakhs each, against maximum three work each work orders consisting of Power transformer of at least 1 MVA rating.</p>			

NOTE:

BIDDERS MUST CLEARLY INDICATE IN THE TABLE ABOVE, HOW THEY ARE SATISFYING TECHNICAL PQR ALONG WITH THE REFERENCE OF THE SUPPORTING DOCUMENTS AND THE PAGE NUMBER IN WHICH THE REFERRED DOCUMENTS ARE ANNEXED IN THE BID DOCUMENT. BHEL WILL NOT CONSIDER ANY OTHER DOCUMENT OTHER THAN THOSE SPECIFIED BY THE BIDDERS IN THE TABLE ABOVE FOR EVALUATION OF TECHNICAL PQR. BIDDER MAY ATTACH SEPERATE SHEET IF NECESSARY

8	Copy of PAN Card	Applicable /Not Applicable	YES/NO
9	Whether all pages of the Tender documents including annexures, appendices etc are read understood and signed	Applicable /Not Applicable	YES/NO
10	Integrity Pact	Applicable /Not Applicable	YES/NO
11	Declaration by Authorised Signatory	Applicable /Not Applicable	YES/NO
12	No Deviation Certificate	Applicable /Not Applicable	YES/NO
13	Declaration confirming knowledge about Site Conditions	Applicable /Not Applicable	YES/NO
14	Declaration for relation in BHEL	Applicable /Not Applicable	YES/NO
15	Non Disclosure Certificate	Applicable /Not Applicable	YES/NO
16	Bank Account Details for E-Payment	Applicable /Not Applicable	YES/NO
17	Capacity Evaluation of Bidder for current Tender	Applicable /Not Applicable	YES/NO
18	Tie Ups/Consortium Agreement are submitted as per format	Applicable /Not Applicable	YES/NO
19	Power of Attorney for Submission of Tender/Signing Contract Agreement	Applicable /Not Applicable	YES/NO
20	Analysis of Unit rates	Applicable /Not Applicable	YES/NO

NOTE : STRIKE OFF 'YES' OR 'NO', AS APPLICABLE. TENDER NOT ACCOMPANIED BY THE PRESCRIBED **ABOVE APPLICABLE DOCUMENTS** ARE LIABLE TO BE SUMMARILY REJECTED.

DATE :

AUTHORISED SIGNATORY

(With Name, Designation and Company seal)

Annexure-3**IMPORTANT INFORMATION**

Sealed Tenders shall be submitted at following address to AGM /Purchase BHEL PSWR NAGPUR:

BHEL PSWR, SRIMOHINI COMPLEX , 345 KINGSWAY, NAGPUR 440001, INDIA

All correspondences regarding this tender shall be addressed to AGM / PURCHASE BHEL PSWR at above address. Bidders may also opt to correspond with following BHEL officials regarding this tender through email at following email ids . However please be informed that sealed tenders shall necessarily be submitted in original at above address:

AGM Purchase, Email id: rajeebc@bhhelpswr.co.in . Ph: +91 – 712 – 3048633

Sr Engineer Purchase, Email: pgv@bhhelpswr.co.in, Ph: +91 – 712 – 3048713

Sr Engineer Purchase, Email: nktiwari@bhhelpswr.co.in Ph: +91-712-3048651

Engineer Purchase, Email id: svm@bhhelpswr.co.in , Ph: +91 – 712 – 3048715

1. **The offers of the bidders who are on the banned list as also the offer of the bidders, who engage the services of the banned firms, shall be rejected. The list of banned firms is available on BHEL web site (www.bhel.com ---> Tender Notification -> List of Banned Firms)**
2. **Refer Chapter XII of Volume IB Special Conditions of Contract regarding Suspension of Business Dealings: The abridged version of extant 'Guidelines for suspension of business dealings with suppliers/contractors' has now been uploaded on www.bhel.com on "supplier registration page" at the following link: http://www.bhel.com/vender_registration/pdf/Suspension-of-Business-Dealings-with-Supplier-issued-Sept13_abridged.pdf**
3. **All Statutory Requirements as applicable for this project shall be complied with.**
4. **Please take note of following Revised Tender Clauses:**
 - i. Notice Inviting Tender: Sl No 9
 - ii. General conditions of Contract: Clause No 1.15.13 (New), Clause No 2.8.3, 2.8.4 and 2.8.5
5. Following Notes are added to Form F- 15 of Volume I D 'Forms & procedures'

-
- i. It is only indicative and shall be as per the online format issued by BHEL time to time.
 - ii. No request will be entertained after specified date of the current month w.r.t the changes requested in the scores of immediate previous month.

6. PRICE VARIATION CLAUSE

Revision in Price Variation Compensation Clause no. 2.17 of Vol I C GCC:

Clause No. 2.17.9 of Vol IC GCC is revised as below:-

PVC shall be applicable only during the extended period of contract (if any) after the schedule completion date for the portion of work delayed / backlog for the reasons not attributable to Contractor. However total quantum of Price Variation amount payable/recoverable shall be regulated as follows:

- i. For the portion of backlog attributable to the contractor and for the portion of backlog due to force majeure condition during contract period, PVC shall not be paid.
- ii. For the period of force Majeure during extended contract period, PVC will be as per the indices applicable at the beginning of the force majeure period.
- iii. void
- iv. The total amount of PVC shall not exceed 20% of the cumulatively executed contract value during the extended contract period. Executed contract value for this purpose is exclusive of PVC, ORC, Supplementary/Additional Items and Extra works.

Clause No. 2.17.5 of is modified as below:-

Base date shall be the calendar month of the (schedule completion date of the contract + Period extended for the reasons due to Force Majeure Condition). Schedule Completion date shall be the actual start date plus contract period as defined in Chapter VI 'Vol IA TCC'

7.OVER RUN COMPENSATION

Revision in OVER RUN COMPENSATION Clause no. 2.12 of Vol I C GCC:

Clause No. 2.12 of Vol IC GCC is Revised as below:-

IF THE CONTRACT IS EXTENDED BEYOND THE CONTRACT PERIOD FOR ANY REASON OTHER THAN THOSE ATTRIBUTABLE TO THE CONTRACTOR OR FORCE MAJEURE CONDITIONS, THE CONTRACTOR WILL BE COMPENSATED BY PAYMENT OF OVERRUN CHARGES AT THE RATE OF **RS.1,00,000/- (Rupees One Lakhs Only)** PER MONTH. OVERRUN COMPENSATION WILL BE PAID FOR THE EXTENSION ATTRIBUTABLE TO BHEL ONLY. NO OVERRUN COMPENSATION WILL BE PAYABLE FOR THE EXTENSION ON ACCOUNT OF REASONS ATTRIBUTABLE TO CONTRACTOR AND/OR FORCE MAJEURE CONDITIONS. OVERRUN COMPENSATION FOR ELIGIBLE PERIOD SHALL BE IN PROPORTION TO THE PROGRESS ACHIEVED AGAINST THE PLAN FOR RESPECTIVE PERIOD.

8. Acceptance of Bank Guarantee (BG)

Revision in Acceptance of Bank Guarantee (BG) Clause no. 1.10.3 (V) of Vol I C GCC:

Clause No. 1.10.3 (V) of Vol IC GCC is revised as below:-

“Bank Guarantee issued by:

- a. Any of the BHEL consortium bank listed below :

State Bank of India
ABN Amro Bank N.V.
Bank of Baroda
Canara Bank
Citi Bank N.A.
Corporation Bank
Deutsche Bank
HDFC Bank Ltd.
The Hongkong and Shanghai Banking Corporation Ltd.
ICICI Bank Ltd.
IDBI Ltd.
Punjab National Bank
Standard Chartered Bank
State Bank of Travancore
State Bank of Hyderabad
Syndicate Bank

- b. Any public sector Bank (other than consortium banks) with a clause in the text of Bank Guarantee that it is enforceable at Nagpur, Maharashtra
- c. Any private sector banks, with a clause in the text of Bank Guarantee that it is enforceable by being presented at any branch of the bank

Note: “Bank Guarantees issued by Co-operative Banks are not acceptable”.

9. Broad Terms & Conditions of Reverse Auction

In continuation to Clause 19.0 of NIT (Notice Inviting Tender) following are the broad terms and conditions of Reverse Auction is given in Annexure V of NIT:

- 9.1. Against this enquiry for the subject item/ system with detailed scope of supply as per enquiry specifications, BHEL may resort to “REVERSE AUCTION PROCEDURE” i.e., ON LINE BIDDING (THROUGH A SERVICE PROVIDER). The philosophy followed for reverse auction shall be English Reverse (No ties).
- 9.2. BHEL reserves the right to go for Reverse Auction (RA) instead of opening the sealed envelope price bid, submitted by the bidder. This will be decided after techno-commercial evaluation. All bidders to give their acceptance for participation in RA. Non-acceptance to

participate in RA may result in non-consideration of their bids. In case BHEL decides to go for Reverse Auction, only those bidders who have given their acceptance to participate in RA will be allowed to participate in the Reverse Auction. Those bidders who have given their acceptance to participate in Reverse Auction will have to necessarily submit „online sealed bid“ in the Reverse Auction. Non-submission of „online sealed bid“ by the bidder will be considered as tampering of the tender process and will invite action by BHEL as per extant guidelines in vogue.

- 9.3. For the proposed reverse auction, technically and commercially acceptable bidders only shall be eligible to participate.
- 9.4. Those bidders who have given their acceptance for Reverse Auction (quoted against this tender enquiry) will have to necessarily submit ‘online sealed bid’ in the Reverse Auction. Non-submission of ‘online sealed bid’ by the bidder for any of the eligible items for which techno-commercially qualified, will be considered as tampering of the tender process and will invite action by BHEL as per extant guidelines in vogue.
- 9.5. BHEL will engage the services of a service provider who will provide all necessary training and assistance before commencement of on line bidding on internet.
- 9.6. In case of reverse auction, BHEL will inform the bidders the details of Service Provider to enable them to contact & get trained.
- 9.7. Business rules like event date, time, bid decrement, extension etc. also will be communicated through service provider for compliance.
- 9.8. Bidders have to fax the Compliance form (annexure IV) before start of Reverse auction. Without this, the bidder will not be eligible to participate in the event.
- 9.9. In line with the NIT terms, BHEL will provide the calculation sheet (e.g., EXCEL sheet) which will help to arrive at “Total Cost to BHEL” like Packing & forwarding charges, Taxes and Duties, Freight charges, Insurance, Service Tax for Services and loading factors (for noncompliance to BHEL standard Commercial terms & conditions) for each of the bidder to enable them to fill-in the price and keep it ready for keying in during the Auction.
- 9.10. Reverse auction will be conducted on scheduled date & time.
- 9.11. At the end of Reverse Auction event, the lowest bidder value will be known on auction portal.
- 9.12. The lowest bidder has to fax/e-mail the duly signed and filled-in prescribed format for price breakup including that of line items, if

required, (Annexure VII) as provided on case-to-case basis to Service provider within two working days of Auction without fail.

- 9.13. In case BHEL decides not to go for Reverse Auction procedure for this tender enquiry, the Price bids and price impacts, if any, already submitted and available with BHEL shall be opened as per BHEL's standard practice.
- 9.14. Bidders shall be required to read the "Terms and Conditions" section of the auctions site of Service provider, using the Login IDs and passwords given to them by the service provider before reverse auction event. Bidders should acquaint themselves of the "Business Rules of Reverse Auction", which will be communicated before the Reverse Auction.
- 9.15. If the Bidder or any of his representatives are found to be involved in Price manipulation/ cartel formation of any kind, directly or indirectly by communicating with other bidders, action as per extant BHEL guidelines, shall be initiated by BHEL and the results of the RA scrapped/ aborted.
- 9.16. The Bidder shall not divulge either his Bids or any other exclusive details of BHEL to any other party.
- 9.17. In case BHEL decides to go for reverse auction, the H1 bidder (whose quote is highest in online sealed bid) may not be allowed to participate in further RA process.

1501

TECHNICAL CONDITIONS OF CONTRACT (TCC)

BHARAT HEAVY ELECTRICALS LIMITED



TECHNICAL CONDITIONS OF CONTRACT (TCC) CONTENTS

SI No	DESCRIPTION	Chapter	No. OF PAGES
Volume-IA	Part-I: Contract specific details		
1	Project Information	Chapter-I	2
2	Scope of Works	Chapter-II	27
3	Facilities in the scope of Contractor/BHEL (Scope Matrix)	Chapter-III	3
4	T&Ps and MMEs to be deployed by Contractor	Chapter-IV	3
5	T&Ps and MMEs to be deployed by BHEL on sharing basis	Chapter-V	12
6	Time Schedule	Chapter-VI	2
7	Terms of Payment	Chapter-VII	3
8	Taxes and other Duties	Chapter-VIII	3
9	Specific Inclusion	Chapter-IX	1
10	Specific Exclusion	Chapter-X	1
11	General	Chapter-XI	1
12	ELECTRICAL AND INSTRUMENTATION	Chapter-XII	12
13	Schedule of items & Quantities and Factor for deriving Item Rate from the accepted Lumpsum Price	Chapter-XIII	4

TECHNICAL CONDITIONS OF CONTRACT (TCC)

Chapter - I : Project Information

1.0	Project Information
1.1	<p>1. Purchaser / Owner : M/s National Thermal Power Corporation Limited. (NTPC)</p> <p>2. Project Title : 2X660 MW NTPC Mouda (Extension of 2x500 MW PHASE-I)</p> <p><u>LOCATION AND APPROACH :</u></p> <p>1. Location : Village-Mouda, Dist- Nagpur State–Maharashtra, India.</p> <p>2. Address Details : 2X660 MW NTPC Mouda. Village – Mouda Taluka – Mouda Dist.- Nagpur Pin Code- Maharashtra State, India"</p> <p>3. Nearest Port : Mumbai</p> <p>4. Nearest Air Port : Nagpur/ 50 KM from Mouda town</p> <p>5. Approach Road : Mouda site is connected to Mouda town by 04 KM long all weather roads. Mouda town is 40 KM from Nagpur on NH-6.</p> <p>6. Railway Approach : Nearest Railway Station Chacher 8 Kms away from site on Nagpur-Kolkata Broad Gauge section of South Eastern Railway (main line)</p> <p>7. Data of Seismic Design : As per IS 1893</p> <p>8. Ambient air temperature (Average) :</p> <p>a) Maximum : 50 degree centigrade</p> <p>b) Minimum : 6 degree centigrade</p>

TECHNICAL CONDITIONS OF CONTRACT (TCC)

Chapter - I : Project Information

09: Average Relative Humidity: 60 %

10: Wind speed : 44 m/s at ten meters above the ground level as per IS 875 (Part-3).

11. Geographical condition: Latitude- 21-10-50 N
Longitude -79-23-52 E

The Bidder shall visit site and get acquainted himself with the conditions prevailing at site before submission of the bid. The information's given here in under are for general guidance and shall not be contractually binding on BHEL/ Owner. All relevant site data/ informations as may be necessary shall have to be obtained /collected by the Bidder.

TECHNICAL CONDITIONS OF CONTRACT (TCC)

Chapter - II : Scope of Works

2.0 SCOPE OF WORK

The scope of work under the specification broadly covers the receipt of materials from BHEL/customer stores/storage yard, handling at stores/storage yard, transportation to site of work, preassembly, erection, testing, pre-commissioning tests and checks and handing over of Electrical **Main Plant Electrical System** & Associated items .

The work under this scope being quite sophisticated and also quite extensive, for proper planning, monitoring, reporting, etc of ongoing works, the contractor shall establish his own computer(s) and printer(s) at his site office, along with suitable operator(s), consumables, etc.

Contractor may tie up with separate suitable agency/agencies for carrying out Bus Duct, Relay Testing and Integrated Testing of Generator System work. However before deploying such agencies on job, the Contractor shall obtain approval of BHEL Construction Manager in writing.

HT/LT power Transformers, Electrostatic Precipitator, Commissioning of HT/LT Drives Electrical Hoists and valve/ damper actuator , Soot Blower System, Cabling package and associated equipments & Associated Auxiliaries for the following: -

1. CABLE TRAY.
2. LT POWER CABLES (Generally Arm/Unarmoured), LT CONTROL CABLES (Generally Arm/Unarmoured, Screened or Unscreened).
3. JUNCTION BOXES AND PUSH BUTTON.
4. STRUCTURAL STEEL.
5. SWITCHGEARS / MCC /PCC
6. STARTER PANEL/LOCAL STARTER BOXES/POWER DISTRIBUTION BOXES /MARSHALLING BOXES..
7. DIGITAL AUTOMATIC VOLTAGE REGULATOR
8. VARIABLE FREQUENCY DRIVE SYSTEM FOR ID FANS
9. SOOT BLOWER SYSTEM.
10. ELECTROSTATIC PRECIPITATOR (ESP).
11. EQUIPMENT EARTHING MATERIALS (ESP).
12. ONLY TESTING & COMMISSIONING.
13. OTHERS EQUIPMENTS.

TECHNICAL CONDITIONS OF CONTRACT (TCC)

Chapter - II : Scope of Works

2.1 GENERAL REQUIREMENTS

2.1.1

The intent of specification is to procure services according to the most modern and proven techniques and codes. The omission of specific reference to any method, equipment or material necessary for proper and efficient execution of this work shall not relieve the contractor of the responsibility of providing such facilities to complete the work without any extra compensation.

2.1.2

The contractor must have the experience of erection of identical work in the past as specified in the tender documents and must have executed contract of similar nature. The contractor must furnish enough evidence to establish his capacity in erection, testing & commissioning of similar equipments covered under this specification

2.1.3

The contractor will have following valid certificates.

- A) Contractor Electrical License for Extra High Voltage System installation work.**
- B) Supervisory Competency Certificate to deal with Electrical High Voltage equipments for their erection, testing & commissioning. During the execution of work, minimum two persons should be posted at site that has valid Supervisory Competency Certificate.**
- C) The contractor should have a very good engineering background and capability of carrying out erection & commissioning work as specified in this tender document.**

2.1.4

The work to be carried out under the scope of this specification covers the complete work of loading, handling, transporting, unloading, preassembly, erection, calibration, testing, air flushing, pre commissioning tests, commissioning of systems, trial run of various auxiliaries and equipments, achieving various milestones till handing over of the unit to BHEL's customer. The work shall conform to dimensions and tolerances specified in various drawings that will be provided during the erection. If any portion of the work is found to be defective in workmanship or not conforming to drawings or other specifications, the contractor shall dismantle and re-do the work duly replacing the defective materials at his cost, failing which the work will be got done by engaging other agencies or departmentally and recoveries will be effected from contractor's bills towards expenditure incurred including 30% departmental charges.

2.1.5

The terminal points decided by BHEL shall be final and binding on the contractor for deciding the scope of work and effecting payment for the work done.

TECHNICAL CONDITIONS OF CONTRACT (TCC)

Chapter - II : Scope of Works

2.1.6

The work shall be executed under the usual conditions affecting major power plant construction and in conjunction with numerous other operations at site. The contractor and his personnel shall cooperate with personnel of BHEL, BHEL's customer, customer's consultants and other contractors, coordinating his work with others and proceed in a manner that shall not delay or hinder the progress of work of the project as a whole.

2.1.7

The work covered under this specification is of highly sophisticated nature, requiring the best quality workmanship, supervision, engineering and construction management. The contractor should ensure proper planning and successful & timely completion of the work to meet the overall project schedule. The contractor must deploy adequate quantity of tools & plants, modern / latest construction aids etc. He must also deploy adequate trained, qualified and experienced supervisory staff and skilled personnel.

2.1.8

Contractor shall erect, align and commission all the equipments and auxiliaries as per the sequence & methodology prescribed by BHEL depending upon the technical requirements. Availability of materials and fronts will decide this. BHEL engineer's decision regarding correctness of the work and method of working shall be final and binding on the contractor. No claims for extra payment from the contractor will be entertained on the ground of deviation from the methods / sequences adopted in erection of similar sets elsewhere.

2.1.9

All necessary certificates and licenses, permits & clearances required to carry out this work from the respective statutory authorities are to be arranged by the contractor expeditiously at his cost in time to ensure smooth progress of work.

2.1.10

The work shall conform to dimensions and tolerances specified in the various drawings / documents that will be provided during various stages of erection. If any portion of work is found to be defective in workmanship, not conforming to drawings or other stipulations due to contractor's fault, the contractor shall dismantle and re-do the work duly replacing the defective materials at his cost, failing which the work will be got done by BHEL and recoveries will be effected from the contractor's bills towards expenditure incurred including cost of materials and 30% departmental overheads of BHEL.

2.1.11

BHEL reserves right to recover from the contractor any loss, which arises out of undue delay/discrepancy/shortage/damage or any other causes due to contractor's lapse during any stage of work. Any loss to BHEL due to contractor's lapse shall have to be made good by the contractor.

TECHNICAL CONDITIONS OF CONTRACT (TCC)

Chapter - II : Scope of Works

2.1.12

All transport equipment, handling equipment, tools, tackles, fixtures, equipment, materials, manpower, supervisors/engineers, consumables etc., except otherwise specified as BHEL scope of free issue, required for this scope of work shall be provided by the contractor. All expenditure including taxes and incidentals in this connection will have to be borne by him unless otherwise specified in the relevant clauses. The contractor's quoted rates should be inclusive of all such contingencies.

2.1.13

During the course of erection, testing and commissioning certain rework / modification / rectification / repair / fabrication etc., may become necessary on account of feedback / revision of drawing. This will also include modifications / re-works suggested by BHEL / customer / other inspection group. Contractor shall carry out such rework / modification / rectification / fabrication / repair etc., promptly and expeditiously. Daily log sheets signed by BHEL engineer and indicating the details of work carried out, man-hours etc. shall be maintained by the contractor for such reworks.

2.1.14

All works such as cleaning, leveling, aligning, trial assembly, dismantling of certain equipments / components for checking and cleaning, surface preparation, fabrication of sheets, tubes and pipes as per general engineering practice and as per BHEL engineer's instructions at site, cutting, gouging, weld depositing, grinding, straightening, chamfering, filing, chipping, drilling, reaming, scrapping, lapping, fitting up etc., as may be applicable in such erection works and which are treated incidental to the erection works and necessary to complete the work satisfactorily, shall be carried out by the contractor as part of the work within the quoted rates.

2.1.15

The contractor shall make all fixtures, temporary supports, steel structures required for jigs & fixtures, anchors for load and guide pulleys required for the work (excepting those specifically included in BHEL scope). However, necessary steel will be provided from the scrap / surplus materials available at site.

2.1.16

The contractor shall take delivery of the components, equipments, chemicals, lubricants etc from the BHEL stores/ storage area after getting the approval of BHEL engineer on standard indent forms of BHEL. Complete and detailed account of the materials and equipments after usage shall be submitted to the BHEL and reconciled periodically.

2.1.17

TECHNICAL CONDITIONS OF CONTRACT (TCC)

Chapter - II : Scope of Works

Contractor shall plan and transport equipments, components from storage to erection site and erect them in such a manner and sequence that material accumulation at site does not lead to congestion at site of work. Materials shall be stacked neatly, preserved and stored in the contractor's shed and at work areas in an orderly manner. In case it is necessary to shift and re-stack the materials kept at work areas/ site to enable other agencies to carry out their work or for any other reason, contractor shall do it most expeditiously. No claim for extra payment for such work will be entertained.

2.1.18

The contractor shall take delivery of equipment, materials from the storage yard/ stores/sheds of BHEL/customer. He shall also make arrangements for verification of equipment, transportation up to site of work, safe custody, watch and ward of equipment after it has been handed over to him till these are fully erected, tested and commissioned and taken over by the customer. The contractor should note that the transport of equipments to erection site, assembly yards etc. should be done by the prescribed route without disturbing the other works and contractors and in the most professional manner. Special equipments such as measuring and control equipments, panels, electronic items, SF6 breakers, switches, cables, conduits etc. shall be stored when taken over by the contractor in appropriate manner as per BHEL's instructions.

2.1.19

Plant materials should not be used for any temporary supports / scaffolding / preparing pre-assembly bed etc.

2.1.20

The services, tests and support to be provided by the agency for the work mentioned in various sections of this tender are indicative and not exhaustive, and not limited to these for completion of the work in all respects.

2.1.21

The weight & dimension as mentioned against the individual items in Price Bid / Rate Schedules or elsewhere in the tender specification are indicative approximate and there may be variation in dimension & weight in actual supply of equipment. No rate variation shall be considered on this account.

2.1.22

The scope of work & description of system / equipment as given in the various clauses of this tender specification and rate schedule are only for understanding the system requirement, contractor shall note this point and assess the volume of work prior to submit the offer.

2.1.23

TECHNICAL CONDITIONS OF CONTRACT (TCC)

Chapter - II : Scope of Works

The contractor shall have total responsibility for all equipment and materials in his custody at contractor's stores, loose, semi-assembled, assembled or erected by him at site. He shall effectively protect the finished works from action of weather and from damages or defacement and shall also cover the finished parts immediately on completion of work as per BHEL engineer's instructions. The machined surfaces/finished surfaces should be greased and covered.

2.1.24

At all stages of work, equipments/materials in the custody of contractor, including those erected, will have to be preserved as per the instructions of BHEL.

2.1.25

The contractor shall make suitable security arrangements including employment of security personnel and ensure protection of all materials/ equipment in their custody and installed equipments from theft/fire/pilferage and any other damages and losses.

2.1.26

The contractor shall collect all scrap materials periodically from various levels of powerhouse, working area of the power station, auxiliary and piping around power station and collect the same at one place earmarked for the same. Loads of scraps are to be shifted to a place earmarked by BHEL. Failure to collect the scrap is likely to lead to accidents and as such, BHEL reserves the right to collect and remove the scrap at contractor's risk and cost, if there is any failure on the part of contractor in this respect. **1% value of each RA bill will be earmarked against compliance of the above, to be released only on satisfactory collection and deposit of scrap as stated above. In case of failure of contractor to comply with this requirement, BHEL will make suitable arrangement at contractor's risk and cost. In such case, any expenditure over and above the withheld 1% amount will also be recovered suitably from the RA bills of vendor.**

2.1.27

The entire surplus, damaged, unused materials, packaging materials / containers, special transporting frames, gunny bags, etc., shall be returned to BHEL stores by the contractor.

2.1.28

The contractor shall not waste any materials issued to him. In case it is observed at any stage that the wastage/excess utilization of materials is not within the permissible limits, recovery for the excess quantity used or wasted will be effected with departmental charges from the contractor. Decision of BHEL on this will be final and binding on the contractor.

2.1.29

TECHNICAL CONDITIONS OF CONTRACT (TCC)

Chapter - II : Scope of Works

For any class of work for which no specifications have been laid down in these specifications, work shall be executed as per the instructions of BHEL.

2.1.30

Housekeeping in the erection and preassembly area is as important as the well-planned and orderly work. The access to site for inspection approaches by BHEL and customer engineers and leading of the material shall be made available by the contractor at all times. The shifting and reshifting of erection materials, tools and plants and clearance of restrictions, filling of ditches, undulation near preassembly and switch yard area is the responsibility of the contractor. Contractor should visit the site and acquaint himself with all restrictions and difficulties that he may encounter during erection/commissioning stages.

2.1.31

The contractor shall handover all parts/materials remaining extra over the normal requirement with proper identification tags in a packed condition to BHEL stores. In case of any misuse or use over actual design requirements, BHEL reserves the right to recover the cost of parts/materials used in excess or misused. Decision of BHEL engineer in this regard will be final and binding on the contractor.

2.1.32

The contractor should take all reasonable care to protect equipment and materials under his custody either in his stores or at site. Copper tubing, brass fittings, brass valves etc. Forming an integral part of equipment or system are liable to greater damages/pilferages /theft / losses. It will be responsibility of contractor to arrange for adequate security round the clock for protection from such damages/pilferages/theft/losses.

2.1.33

The contractor shall ensure that all the packing materials and protection devices used for the various equipments during transit and storage are removed before these equipments are erected in position.

2.1.34

Overhauling, cleaning, revisioning, servicing of equipments during erection and commissioning stages will be arranged by the contractor. All equipments shall be preserved and protected before and after erection as per the advice of BHEL engineer.

2.1.35

Substantial portion of cable laying & termination shall be done by other agencies for the equipment covered under this tender specification. The glands & lugs shall be supplied either loose or fitted with the equipments. Contractor shall take care of this aspect at the time of receipt of the equipment from BHEL stores. Contractor shall account for the quantities received with equipments and shall hand over the same to

TECHNICAL CONDITIONS OF CONTRACT (TCC)

Chapter - II : Scope of Works

cabling agency under intimation to BHEL Engineer. Contractor shall extend all necessary help & co-ordinate with the cabling agency during the course of work.

2.1.36

Contractor will be required to maintain in his site office at least one PC along with minimum accessories like printer, etc to enable him to carry out site activities in a planned, well coordinated and smooth manner.

2.1.37

Contractor shall prepare Marked-Up drawings incorporating modifications and deviations from original drawings or prepare fresh sketch for actual installation / connection details if need be, that can be converted to "As-built" drawing.

2.2 TESTING, PRE-COMMISSIONING, AND POST COMMISSIONING:

2.2.1

The contractor shall perform various activities during pre-commissioning, integrated testing, post-commissioning stages of equipment covered under this tender specification. It is responsibility of contractor to arranged tools & plants, test equipments, experienced engineers and technicians. Contractor shall earmark separate manpower for respective commissioning areas and they shall not be disturbed /diverted for other work. The contractor's commissioning group shall work as per the instruction of BHEL Engineer and they shall coordinate day-to-day activity with other agency and BHEL/ Customer. The testing activity may have to be repeated till satisfactory results are obtained and also to satisfy the requirement of Customer / statutory Authority.

2.2.2

The contractor shall simultaneously start testing & commissioning activities for equipments to match the mile stone activities of the project.

2.2.3

The mobilization of these commissioning groups shall be such that planned activities are taken up in time and also completed as per schedule and work undertaken round the clock if required. It is responsibility of contractor to discuss on day to day / weekly / monthly basis the requirement of manpower, consumables, tools & tackles / testing equipments with BHEL Engineers and arrange for the same. If at any time the requisite manpower, consumables, testing equipments etc are not arranged then BHEL shall make alternative arrangements and necessary recoveries with overhead cost will be made from the running bills.

2.2.4

TECHNICAL CONDITIONS OF CONTRACT (TCC)

Chapter - II : Scope of Works

Contractor shall cut/open work, if needed, as per BHEL engineer's instructions during commissioning for inspection, checking and make good the works after inspection is over.

2.2.5

It shall be specifically noted that the contractor may have to work round the clock and in shifts during the pre-commissioning and commissioning period along with or without BHEL engineers and hence considerable overtime payment is involved. The contractor's quoted rates shall be inclusive of all these factors.

2.2.6

In case any rework/ repair / rectification/ modification / fabrication etc is required because of contractor's faulty workmanship which are noticed during the commissioning of, at any stages, the same shall be rectified by the contractor at his cost. If during the commissioning any improvement / repair / rework / rectification / fabrication / modification due to design improvement is required, the same shall be carried out by the contractor promptly and expeditiously.

2.2.7

During the commissioning activities and carrying out various tests, if any of temporarily work such mounting of test equipments / cabling etc are required, the contractor shall carry out such work without any extra cost. The same shall be removed after completion of the activity.

2.2.8

During this period, though BHEL/ client's staff will also be associated in the work, the contractor's responsibility will be to arrange for complete requirement of men and required Tools & Plants, Consumables, Scaffolding and approaches etc., till such time the commissioned unit is taken over for trial operations.

2.2.9

The contractor shall carry out any other tests as desired by BHEL engineer on erected equipment covered under the scope of this contract during testing, pre-commissioning and commissioning, to demonstrate the completion of any part or whole of work performed by the contractor.

2.2.10

The pre-commissioning activities will start in a phased manner to meet the various milestones and shall continue till equipments are commissioned fully with all connected equipment / devices or handed over to customer for regular operation. In this duration other erection activities such as cabling etc., shall be carried out by other agencies even though equipments are partially commissioned / charged. In order to co-ordinate the work such as issue of safety permit, normalization and compliance of other requirement, contractor shall keep team of experienced engineer, supervisor, technician and helper in

TECHNICAL CONDITIONS OF CONTRACT (TCC)

Chapter - II : Scope of Works

each shift as decided by BHEL Engineer. The team shall take instruction from BHEL Engineer for day-to-day work and shall not be diverted for other work. No extra payment shall be made for their services.

2.3 WELDING, NON-DESTRUCTIVE TESTING ETC.

- A) Installation of equipment involves good quality welding, NDE checks etc.
- B) Welder deployed for aluminium welding shall have experienced and approved by BHEL and BHEL's Customer after due qualification process/testing.
- C) Welding of all structural steel & aluminium shall be done only by the qualified and approved welders.
- D) All the welders shall be tested and approved by BHEL engineer/ Customer's quality engineer before they are actually engaged on work though they may possess IBR/other certificate. BHEL reserves the right to reject any welder without assigning any reason.
- E) The welded surface shall be cleaned of slag and painted with primer paint to prevent corrosion. For this paint will be supplied by the contractor.
- F) Welding electrodes have to be stored in enclosures having temperature and humidity control arrangement. This enclosure shall meet BHEL specifications.
- G) Certain types of coated welding electrodes, prior to their use, call for baking for specified period and will have to be held at specified temperature for specified period. Also, during execution, the coated welding electrodes have to be carried in portable ovens.

2.4 MEASUREMENTS & WASTAGE & CUTTING ALLOWANCES:

2.4.1

For all payment purposes, measurement shall be made on the basis of the actual execution of work in line with drawings/documents/site requirements. Physical measurements shall be made by the contractor in the presence of the Engineer.

2.4.2

The measurement for cable, impulse pipes/tubes, GI pipe, conduits, flexible conduits, trays etc., shall be made on the basis of length actually laid.

2.4.3

TECHNICAL CONDITIONS OF CONTRACT (TCC)

Chapter - II : Scope of Works

All the surplus, scrap and serviceable materials, out of the quantity issued to the contractor shall be returned to BHEL in good condition and as directed by the engineer.

2.4.4

All materials returned to stores should carry aluminium tag indicating the size and type. Cables more than 15 meters length is termed as serviceable material and shall be returned size wise and category wise to the owner's stores/yard. Cable of serviceable length being returned to the stores in drums shall have their free ends sealed and the balance lengths on the drum(s) shall be noted and certified by the Engineer-in-charge. This shall be applicable only for the purpose of accounting the cables issued for installation.

2.4.5

While carrying out material reconciliation with contractor, all the above points will be taken into account. All serviceable material returned by the contractor shall be deducted from the quantities issued for the respective sizes and categories and the balance quantity (ies) will be taken as the net quantity (ies) issued to the contractor. Material reconciliation shall be done and allowable scrap quantity calculated as per wastage allowance percentage specified above. Any scrap/wastage generated by the contractor in excess of the allowable percentage shall be charged at the rates decided by the Engineer whose decision shall be final and binding on the contractor.

2.4.6

For all site-fabricated steel items such as supports, racks, frame, Canopy etc. physical measurement shall be made and then converted to tonnage. For steel material supplied to the contractor, all scrap shall be returned to BHEL stores with due accounting.

2.4.7

Every month the contractor shall submit an account for all the materials issued to him by BHEL in the standard Performa prescribed for this purpose by the site in charge.

2.4.8

The erection contractor shall make every effort to minimize wastage during erection work. Cutting and wastage allowance shall be computed on length, weight of material actually used, measured and accepted. In any case, the wastage shall not exceed the following limits;

<u>Sl.No.</u>	<u>Item</u>	<u>% Wastage on issued Qty</u>
01.	Each iron/steel section	2
02.	Each size of power cables	1
03.	Each size of control / shielded cable	2

2.4.9

If the actual wastage is more than the specified figure, then equivalent price of the excess portion will be deducted from the contractor's bill.

TECHNICAL CONDITIONS OF CONTRACT (TCC)

Chapter - II : Scope of Works

2.4.10

The cable take off from drums shall be planned strategically such that jointing in the run of cables and wastage are avoided. For this purpose the exact route length between various equipment/panels as per the cable schedule shall be measured and the route length recorded before laying of the cables. Depending upon the route length and the type of cable required for various destinations, the cable drums shall be suitably selected for cable laying. Any jointing shall have to be approved by BHEL engineer. All the cut pieces/bits of cables, which are not used, shall be returned to the purchaser for accounting towards wastage. The cables damaged by the contractor shall have to be replaced by the contractor at his own cost.

NOTE: Salvageable scrap shall mean lengths of pipes, multi core cables, other cables etc., that can be used one time or other at a later date and normally they are recovered from the cut-pieces of pipes, multi core cables, cables etc.

Non - Salvageable scrap means the lengths of tubes, pipes, multi core cables, cables etc., and they are from cut-pieces of tubes, pipes, multi core cables, cables etc., that cannot be used at all one time or other.

2.4.11

The rate of laying for LT power, control and signal cable is inclusive of glanding and termination at both ends. Glands & Lugs above 4sq mm shall be supplied by BHEL Lugs up to 4 sq mm shall be in vender's scope. **The LT Power Cable straight through Jointing Kit (if required) shall be in Vendor's scope of supply. The rate for erection will be part of laying rates. No separate rate is applicable on this account.**

The unit rates for the HT cable termination (if applicable) are exclusive of unit rates for laying of HT cables. Glands & termination kits for HT cables (3.3KV and above) shall be supplied by BHEL.

2.5 FINAL PAINTING

- A. The contractor shall provide all the primer, paint, and other consumables like brush, cleaning agents etc. All T&P, manpower, supervision is in contractor's scope. Painting shall be carried out as per colour scheme approved by BHEL/ BHEL customer.
- B. All metal parts of the equipment including supports, structures, etc., as applicable shall be painted after thoroughly cleaning the surface from dust, rust, greases, oils, scales, etc, by wire brush, scrapping, sand blasting/ shot Blasting (**as applicable**) etc; as specified in relevant erection documents. The above parts shall then be painted with specified two coats of specified paint over the shop primer/paint. Also, where the shop primer/paint has peeled off, the affected area shall be cleaned

TECHNICAL CONDITIONS OF CONTRACT (TCC)

Chapter - II : Scope of Works

thoroughly by the specified method and then primer coat applied. Similarly, certain components may be supplied without any primer/paint coat from shop. The surface of such items shall be cleaned as per specifications, coated with suitable primer and then coated with final paint coats. The dry film thickness after final coat should be as per specification. The color, shade etc. shall be as per specification. Painting schedule will be furnished at site. The scope of painting work is for the following areas. Primer and paint shall be sourced only from the following manufacturers or any other manufacturers approved by BHEL.

Berger Paints (I) Ltd.

Asian Paints Ltd.

Goodlass Nerolac Paint Ltd.

Jenson & Nicholson Ltd.

Shalimar paints Ltd.

In order to have consistency in painting system, it is preferable that all the supplies are sourced from one single manufacturer.

- C. All the fabricated frames, racks, supports, panel base frame etc. wherever applicable shall be painted with two coats of primer and followed by two coats of paint as specified earlier herein. **In case of G I Structure, The cold galvanizing paint to be applied as touch up where ever needed.** This is to be done as per instruction of BHEL engineer. The Paint required for this purpose is in scope of Contractor
- D. Touch-up painting of LT MCC \ Control Panels or any other equipment /devices wherever necessary.
- E. The primer shall be compatible with the final coat paint schedule.
- F. Full (Spray) painting of transformers, bus ducts with two coats of paint as per specification
- G. Supply of paint, primers, other consumables etc for above and any other scope in these specifications shall be in Contractor's scope.
- H. Irrespective to scopes of painting & supply of paint mentioned elsewhere it is to be noted that supply of paint, primers, other consumables etc for all primer/painting works to be done by the contractor, shall be in Contractor's scope. No dispute shall be entertained on the above matter.
- I. Colour Banding, Legend and Identification Marking, Direction marking etc. shall be in scope of the contractor.

TECHNICAL CONDITIONS OF CONTRACT (TCC)

Chapter - II : Scope of Works

2.6

The work under this scope being quite sophisticated and also quite extensive, for proper planning, monitoring, reporting, etc of ongoing works, the contractor shall establish his own computer(s) and printer(s) at his site office, along with suitable operator(s), consumables, etc. **Non-establishment of above equipment will attract penalty @ Rs 10000 (Rs Ten thousand only) per month.**

BHEL uses its own software SOMS (Site Operation and Management System) for total project execution and billing. The contractor shall also provide adequate and suitable manpower for updating / entries into SOMS in BHEL computers at site.

2.6 Troubleshooting during plant operation

During pre commissioning / commissioning stages when the plant will be under various stages of operation, it will be necessary to have continuous (day and night) presence of suitable manpower along with required tools to attend to any defects etc that may arise during such operation. The contractor will be required to put such personnel in shifts in electrical area. The bidder must also take this aspect into consideration.

2.7

Equipments / instruments etc., under the above scope of erection and commissioning are generally dispatched from BHEL's manufacturing units / vendor's works at site well before start of erection. Sometimes, such dispatched materials may get stuck up with transporters/railways. The contractor shall provide support / manpower for necessary chase up for removal of such bottlenecks in transportation. Also, for smaller items, it could be necessary to depute his person to personally carry certain items from works to site. Requirement of such activities, which will be decided by BHEL engineer and chase up activities, if required, shall be performed under authorization by BHEL. The above services shall be provided within the quoted rates.

2.8 STATUTORY CLEARANCES

1. Contractor should have / Obtain valid Electrical Contractor-ship License to carry out the Erection, Testing & Commissioning work on High / Low Voltage electrical equipments from the

TECHNICAL CONDITIONS OF CONTRACT (TCC)

Chapter - II : Scope of Works

appropriate statutory authority of concern state or Central Electricity Authority, as the case may be. All fees and expenses in this regard shall be in the contractor's account.

2. Contractor shall arrange inspection of concerned Statutory Authority for the installation, testing & commissioning of High / Low voltage equipment covered under this tender specification and obtain their approval in appropriate format prior to charging of the equipments.

3. Contractor shall be responsible for all necessary liaisoning work with Statutory Authority towards the certification of installation / works. BHEL shall reimburse Statutory Fees as per actual on submission of original receipt, however all incidental expenses shall be borne by Contractor. BHEL/ BHEL's Customer shall be providing technical assistance, drawing & document for submission to Statutory Authority. Contractor shall provide all logistics services in this regard.

4. The installation of all electrical equipments shall be carried out only by persons holding valid certificates of Competency for the voltage classes as defined in this tender specification, issued by appropriate state or central Statutory Authority. Contractor shall submit the particulars of Licenses held by him.

5. For carrying out the works covered under this contract the contractor has to arrange electrical license of the concerned state where the project is being executed. This is to be arranged within 6 weeks of mobilization at site. Failure to arrange the requisite license shall invite withholding Rs 1.0 Lakh per month, deductible from running bills till it is obtained. This amount, thus withheld may be refunded on meeting statutory requirements.

TECHNICAL CONDITIONS OF CONTRACT (TCC)

Chapter - II : Scope of Works

2.9 The contractor's scope of work is further described in the clauses hereafter:

The work will comprise of, but not limited to the following:

2.9.1 CABLE TRAYS/CABLE DUCTS

A Various types of sheet metal, galvanized cable tray, i.e. perforated, ladder type, sheet metal duct, solid bottom trays, pre-fabricated structural trays etc., will be supplied in standard lengths along with accessories and hardware viz; coupler plate, tray covers and tray clamps etc.

B Installation of cable tray/cable duct shall include cutting, laying, jointing, fixing tee/reducers/ bends/clamps, fixing of tray covers, hardware, welding of tray supports as per tray route layout etc.

C Fabrication of bends/tee/ reducers from straight length of tray is within the scope of work and rate quoted shall be inclusive in unit rate (in running meter). All site welds of cable trays shall be painted with approved primer and cold galvanizing paint, which shall be arranged by the contractor.

D In case structural cable trays, bends, tees, reducers etc., are required to be fabricated from structural steel and installed, unit rate applicable for fabrication and installation of structural steel shall be applicable in such instances.

E Cable trays/duct etc may have to be routed underground in cable trench, over head on structure, along the walls, floors etc.

2.9.2 CABLE LAYING - (POWER / CONTROL / INSTRUMENTATION SHIELDED CABLES / PLUG-IN CABLES / DATA HIGHWAY, ARMoured / UN-ARMoured, SINGLE / MULTI-CORE, PVC / HR PVC / FRLS / TEFLON / XLP INSULATION)

1. Cable laying includes cutting to the required length, laying in overhead Cable racks / underground cable trenches, pipes, flexible conduits, dressing/clamping in tray, drilling of holes in gland plates in panels and junction box, glanding, splicing, dressing of spliced wire inside the panel and JB's, **providing printed ferrules (ferrule printing machines to be provided by contractor for printing necessary cross ferruling details) / PVC numerical / alphabetical ferrules (where printed ferrules not possible at all) machine engraved ferrules sleeve/ ferrule**, termination by using crimp type copper tinned/aluminium lugs, insulated/un-insulated, crimp and soldered termination, plug-in connections with insert type crimping, providing identification cable tags of PVC/aluminium at both the ends and at appropriate interval (Approximately 30meters) throughout the route length, continuity checking, insulation resistance checking, high voltage test

TECHNICAL CONDITIONS OF CONTRACT (TCC)

Chapter - II : Scope of Works

- on HT cables. Contractor to arrange adequate numbers of his own ferrule printing machines.
2. Entry to the panels, JB's may be at top, side or bottom. All cable are required be supported and clamped near to the panel.
 3. Wherever cable glanding is not possible, either due to the gland plate size limitations or more number of cable entries, cables may have to be lifted inside the panel by making large cut-out in gland plate and providing 4 or 6 inch PVC pipe coupling glands. These pipe coupling glands shall be supplied by contractor within the quoted rates of cable laying.
 4. Copper tinned lugs of various types up to 4 sq mm conforming to IS: 694 (pin, ring, fork, snap-on) for cables, PVC cable ties, PVC ferrules, PVC button and tapes, cable identification tag of PVC/metal as per site requirement, clamping and dressing material such as suitable cable ties/ clamps etc with hardware, PVC sleeves etc. shall be supplied by contractor within the quoted rate for cable laying. **However trefoil clamps with hardware for Single core power cable shall be supplied by BHEL.** The quality and make of cable lugs shall be got approved from BHEL engineer prior to their use on job.
 5. All care should be taken to avoid abrasion, tension, twisting, kinking and stretching of cables during installation.
 6. Cable shielding – all signal cables are supplied with bare shielded copper wire/with braided wire shield. Generally, shield wire is kept isolated at instrument/field device end and continuity is maintained through JB's and earthed at panel end only. While terminating the shield wire in either panel or JB's, PVC sleeves are to be used to avoid two-point earthing.
 7. Spare holes in the panels / Instruments / Actuators / Motors / JB's etc shall be sealed by suitable method by contractor. (The cost of work and Materials such as aluminium sheet or Adhesive tape / Plugs etc shall be within the quoted rates for laying of cables).
 8. Many of the cable trays and cables have to be laid in cable trenches. For this purpose, the cover of the trenches have to be opened for working in site and whenever the cables are to be laid in existing cable tray, all safety precautions have to be observed. After completing the work, the trenches have to be cleaned and covers put back into position. Contractor shall also carry out de-watering from the trenches if required and arrange pumps etc. at his cost.
 9. Looping wire at terminal block of panels and electrical actuator as shown in the inter-connection diagram is to be done by contractor at no extra cost.
 10. Contractor shall carefully plan the cutting schedule of each cable drum in consultation with BHEL site engineer such that wastages are minimized. Recovery will be made in case the wastages are exceeding the wastage allowances fixed in this contract.

TECHNICAL CONDITIONS OF CONTRACT (TCC)

Chapter - II : Scope of Works

11. Unit rate quoted for cable lying shall include the activities as defined above from Sl. No. 1 to 11.

2.9.3 JUNCTION BOXES/PUSH BUTTONS

1. Checking of installation for correctness.
- 2 Functional checking/ adjustment of JB / PB for their system.

2.9.4 STRUCTURAL FABRICATION AND INSTALLATION

A INSTRUMENT/ JUNCTION BOX FRAME/ PANEL BASE FRAME / CABLE TRAY & MISC STRUCTURES FABRICATION

1. Structural steel material like MS angles, channels, beams, flats, plates etc. shall be supplied in running meter and the same shall be used for misc fabrication if required and the same shall be used for fabrication of panel base frame, cable tray supports, Canopies for instruments/panels/ drives/JB's/Push Buttons etc., Instrument/Junction box frames, Impulse Pipe/Instrument Air Pipe supports and instruments etc.
2. This shall include cutting to size, contouring of ends for connections if required, welding, grinding of excess weld deposits/burrs, drilling of holes for mounting of device/instrument, installation at location, leveling, alignment, providing bracings and painting etc. No gas cut holes will be permitted.
3. All the fabricated supports/frames for instruments, trays, pipes, electrical equipments, etc., shall be epoxy painted after sand blasting / shot blasting (as applicable) and surface preparation as per painting specifications. Paints and other associated items are in the scope of the contractor.
4. Frame installation at site may involve mounting either on concrete floor by grouting / using anchor fasteners or on steel structure by welding etc. All consumables including anchor fasteners shall be arranged by the contractor. Where required, as part of work, concrete floors may have to be chipped out to reinforcement depth for anchoring the frames. Wherever grouting is required, contractor shall arrange all the required material including cement / grout mix, shuttering etc., necessary labour and meet all other requirements as part of work.
5. In case, structural cable trays, bends, tees, reducers etc., are required to be fabricated from structural steel and installed, unit rate applicable for fabrication and installation of structural steel shall be applicable in such instances.

TECHNICAL CONDITIONS OF CONTRACT (TCC)

Chapter - II : Scope of Works

6. In certain packages, members of frames/rack for mounting of junction boxes/instruments may be supplied readymade. These have to be assembled prior to installation. The installation rate as quoted shall include assembly of the frames.
7. **Gas cutting of tray/impulse pipe support and holes in frame is not permitted. Only hacksaw cutting/ drilled hole shall be permitted.**

B. METAL CHANNEL FLEXIBLE BOLTABLE CABLE SUPPORT SYSTEM

Flexible GI cable support system, consisting of single/double channels, base plates, and cantilever arms are as per BOQ (Rates are to be coated including all accessories except those listed in BOQ section E1B). Wherever necessary, the base plate beam clamps will be supplied for bolting. Otherwise, the base plates are to be welded to the racks or beams if necessary at 90 deg. Drgs. are attached with tender are typical sections for information of items and its accessories.

Angle fittings, flat plate fittings, clamps for single & double channels, fasteners etc. will be supplied for fixing trays and cantilever arms and for this no separate erection charges will be paid. Rates shall be inclusive in quoted rates for erection of support channel and cantilever arm. Brief scope of work is further defined as below:

1. Metal channel boltable GI cable support shall be supplied. Each cable rack assembly comprises of sub components such as single or double channel, base plate for single/double channel, angle fitting, clamps, cantilever arm, anchor fastener, associated hardware (spring loaded nuts, bolts and washers) etc.
2. Channel shall be supplied in standard length of six meter. Contractor shall cut the channel and assembly the rack as per site requirement. Cantilever arm is to be fixed on channel support with spring loaded nuts / bolts as per installation drawing.
3. Base plate / angle fitting shall be continuously welded all around to steel members /plate insert if provided. Brackets / clamps shall be welded to steel surface with channel as applicable in position to ensure alignment of clamps / channels. Weld thickness shall be 6 mm minimum. In case steel surface is not available for welding, anchor bolts is to be used for fixing the base / angle fitting.
4. Main support for longitudinal cable tray run in the cable vaults shall be fixed at both ends at top as well at bottom as out lined above.
5. Galvanisation damaged due to welding / cutting shall be re-painted with cold galvanising paint (paint in contractor's scope).
6. Unit rate for **“Single / Double Channel”** shall include cutting channel in required lengths, fixing of angle fittings/ base plate / clamps / brackets / fasteners/ cantilever arms /, welding etc as required as per type of installation.

TECHNICAL CONDITIONS OF CONTRACT (TCC)

Chapter - II : Scope of Works

2.9.5 MCC & DC DISTRIBUTION BOARD ETC

1. Checking of installation for correctness.
2. Mechanical functional checking/ adjustment of individual breaker.
3. Measurement of Insulation resistance of individual breaker, complete switchgear board and combined insulation resistance of individual breaker with cable connected to drives.
4. Testing of Protection Relay, Thermal over relay, Power transducers, Energy/ Ammeters, Voltmeters, Power factor, frequency, tri-vector meters & metering etc. in static & dynamic condition relay.
5. Conducting test such as Insulation Resistance measurement, Ratio, polarity, magnetization characteristic, winding resistance on CT and PT.
6. Calibration of energy meters, tri-vector meters, voltmeters, ammeters, power current & voltage transducers etc.
7. Provide assistance for checking the electrical operation of individual breakers from remote panels / MMI package (max DNA system).
Other than the above, minor testing / checks will also be involved in the generator area, which are also in the scope of the contractor. Any instruments / tools etc required for carrying out the above shall be arranged by the contractor within the quoted rates.

2.9.6 INSTALLATION OF PANELS (STARTER PANEL/LOCAL STARTER BOX/POWER DISTRIBUTION BOX / MARSHALLING BOX / CONTROL PANELS)

1. Electrical control panels, electronic control panels, 415 volt LT MCC's, are normally supplied in suit of either one/two/three or loose shipping sections with integral base frame or loose base frame. These panels may have to be installed as stand-alone or in-group consisting of number of panels in each row, depending upon the plant layout and foundation arrangement.
2. The panels shall be transported from stores to the place of installation in vertical position. Care shall be taken such that the switches, lamps, instruments etc. mounted on the panel do not get damaged during transit.
3. Installation of panel shall include fixing of base frame, leveling, alignment, fixing of anti-vibration pads, removal of side covers, fixing of cubical interconnection hardware, interconnection of bus bar /bus bar jointing, wiring interconnection, welding and grouting of panels and base frames, mounting of panel canopy wherever supplied as part of panel, drilling of gland plates, sealing of panels/ cable entries. Where the base frame is not supplied as part of panel supply, the contractor shall fabricate the base frame from structural items at site. Payment for such fabrication will be effected on measured quantity at the rate applicable for structural steel fabrication and installation. Proper sealing of all the holes and cable entries (even if the cable has been laid by others) in the panel is in the contractor's scope.

TECHNICAL CONDITIONS OF CONTRACT (TCC)

Chapter - II : Scope of Works

4. Panels have to be shifted to their locations through floor openings, temporary openings like floor grills, door etc. This shall be a part of work and no claim whatsoever will be entertained with regard to non-availability of opening as per shortest route etc. Panels have to be erected at different locations and elevation in power house building, LT & HT switchgear room, unit control room etc.
5. Panel and instruments once erected in position should be properly protected using necessary care to prevent ingress of dust/moisture and rainy water. This will have to be periodically cleaned and surroundings have to be kept tidy.
6. Whenever the panels are to be mounted on cable trenches, channel supports have to be provided across the cable trench over which the base frame of panel shall be mounted. For such work, structural steel fabrication & installation rate shall be applicable.
7. **Normally the panels shall be supplied with meters, relays, electronic modules, and contactors, pushbuttons etc mounted and pre-wired. However, if such devices are supplied loose/separately for safety in transit, contractor shall mount the same as part of panel installation work and terminating the wires on devices. No extra payment shall be made for this.**
8. Supplier's instruction manuals, packing slips, door keys etc. received along with the panels will be handed over to BHEL's engineer on opening of the panels and record of receipt of such things shall be maintained by contractor.
9. Regular cleaning of the panels as per the instruction of BHEL engineer till handing over of the set to customer is to be carried out by the contractor free of cost.
10. **Interposing Relays (24 / 48 Volt DC) along with mounting base shall be supplied separately for mounting in the various feeders of 11KV / 6.6 KV HT switchgear boards and 415 Volt MCC Board for uni-directional / bi-directional drives, solenoid valves. 2 Nos. interposing relay are required to be mounted in each feeder. Internal wiring for these relay shall be pre-wired in the feeders, wires to be terminated on relay terminals. Approximately quantity is 1700 Nos. Contractor shall mount the same and terminate the wire as part of panel installation work and no extra payment shall be made for this work.**

2.9.7 ~~VARIABLE FREQUENCY DRIVE (VFD) FOR I.D. FANS VOID~~

~~VFD system comprise for each ID of Power Transformers 6.6/2.3 KV, 3250 KVA, ONAN cooled (2 Nos.), Vacuum Circuit Breaker type VM-12(2 Nos.), D.C. Series Reactor(2 Nos.), Control panels (1 NO.), Load Converter / Inverter panels (2 Set each suit of 3 panels.), Adapter Panel (2 Nos.) and associated accessories. For detail work scope refer other relevant clause for transformer, switchgear & panels. VFD reactor enclosures~~

TECHNICAL CONDITIONS OF CONTRACT (TCC)

Chapter - II : Scope of Works

~~may be supplied loose. Assembly of the same at site is to be carried out within the quoted rates.~~

2.9.8 SOOT BLOWER SYSTEM

Soot blower system comprises of motor control centre / Local Starter Boxes having various feeders of motor starters / Switch Fuse Units , micro-processor based PLC panel with mimic diagram and control station, push button boxes, junction boxes, wall blowers/LRSB with drive mechanism, integral control box with limit switch and internal wiring, inter connecting cables between field blowers and MCC, PLC panel etc. The scope of work for testing, commissioning covers the items/devices as per rate schedule and the testing, commissioning of blowers shall be carried out in close co-ordination with mechanical agencies who shall be erecting these blowers and contractor shall obtain clearance from BHEL engineer prior to start of work. The contractor shall carry out the following works under testing & commissioning:-

- 01 Pre-commissioning checks and tests on MCC's / Local Starter Boxes, soot blowers, PLC panels, energisation of MCC and its feeders, wiring checks, insulation resistance measurements, testing of thermal over load relays etc.
- 02 Adjustment of limit switches, torque switches, internal wiring checks, minor wiring modification to suit to system requirements for wall/LRSB blowers.
- 03 Electric operation of each blower from local, MCC / Local Starter Box and PLC panels and from Unit control board.
- 04 Providing loop on terminal block of MCC individual feeders & blowers.
- 05 During pre-commissioning / post-commissioning of soot blower system, the component like TB's, limit switch, torque switch, over load relay, contactors etc. if found defective, contractor shall replace such components without any extra payment.

2.9.9 ELECTROSTATIC PRECIPITATOR

1. ESP shall have Six flue gas passes and each pass comprises of HT rectifier transformer (silicon oil filled), Auxiliary Control Panels, electronic controller, LT Main switch board and its bus duct, Drives for Rapping / Collecting / Gas damper screen, heating element for hoppers / shaft and supporting insulator housing, ash level indicator and EP management (IOS) system (software based) including computer interface and associated interlock and protection.
2. HT rectifier transformer shall be erected by mechanical agencies. Scope of work covered under this contract is oil filtration of transformers (If BDV Value is less than prescribed in O&M Manual / FQP / Commissioning check list / applicable standard) and erection and testing of various devices as listed in rate schedule. Contractor shall provide silicon oil filter machine as a part of scope. Contractor has also to provide operator round-the-clock for oil filtration and other necessary testing

TECHNICAL CONDITIONS OF CONTRACT (TCC)

Chapter - II : Scope of Works

equipments. Contractor shall utilize power supply for filter machine from the source, which is given for the construction purpose, and shall arrange required cables.

2.9.10 BRUSHLESS EXCITAION SYSTEM :

System comprises of DAVR Panel which is connected by Input cable from DAVR to PMG, DAVR to Main Exciter, DAVR to axis coil , Mounting of Local Instrument in Exciter Enclosure, Winding resistance & IR value of PMG, Main Exciter, Q axis coil, Diode wheel, Checking healthiness of diodes / Fuses, Commissioning of stroboscope, Exciter Heater / Blower, Rotor earth fault brush checking / setting, Lighting inside exciter enclosure, Flap actuator commissioning (If provided). Any other work inside exciter enclosure, Mounting of loose components supplied for Brushless exciter system, Dummy load test of DAVR, Checking from Control desk & Field related inputs/ outputs to commission the excitation system fully operational, **No separate item rate is applicable. Rate quoted by contractor shall be inclusive of all above related to Excitation system.**

2.9.11 SCOPE OF ABOVE GROUND EARTHING

2.9.11.1

The contractor shall carry out above ground earthing for all Electrical equipment, which may be erected by him, or some other agency. Different type of earthing materials shall be supplied and the contractor shall lay and connect the earthing materials as per site requirement and as detailed in drawings. Unit rate for earthing material shall be paid on running meter basis.

2.9.11.2

All equipment shall be earthed by two separate and distinct connections. Earthing terminals will be available in all the equipment supplied by BHEL.

2.9.11.3

Generally risers are provided near the structure / equipment foundation, In case risers are not visible and buried below the foundation level, contractor shall carry out necessary earth excavation for connecting the above ground earthing strips. Wherever welding is involved necessary protective coating shall be applied on weld joints.

2.9.11.4

The earthing conductors shall be mild steel/G.I. strips/wires. All connections from the equipment to the main earthing conductors shall be made as illustrated in earthing drawings. A copy of earthing drawing shall be provided to the successful bidder.

2.9.11.5

TECHNICAL CONDITIONS OF CONTRACT (TCC)

Chapter - II : Scope of Works

A continuous earthing conductor shall be installed in all cables trays and securely clamped to each tray section by suitable connectors to form a continuous earthing system. When two or more trays supporting power cables run on parallel a continuous earthing conductors shall be provided on one tray only with tap-offs to the control cable trays. All valve and damper motor and rapping motors will be earthed to this conductor.

2.9.11.6

If the equipment is not available at the time of earthing conductor laying tap connections from the main earthing conductor shall be brought out up to slab equipment foundation level with at least 200 mm spare length left for further connections to equipment earthing terminals.

2.9.11.7

Entire system shall be earthed in accordance with the provisions of the relevant IEC recommendations/IS code of practice IS 3043-1947 and Indian Electricity Rules, so that the values of the step and contact potentials in case of faults are kept within safe permissible limits.

2.9.11.8

Parts of all electrical equipment and machinery not intended to be live shall have two separate and distinct earth connections each to conform to the stipulation of the Indian Electricity Rules and apparatus rated 240 V and below may have single earth connections.

2.9.11.9

If any outer shops and buildings as well as the electrical sub-stations and electrical rooms are also in contractor's scope, a ring main earthing system will be provided. Ring main earthing systems shall again be interconnected as a network to power plant main earthing mat. Internal earthing ring in the electrical equipment room provided by the contractor whether equipment of the area is in their scope of not.

2.9.11.10

For different floors in a building, localized internal earthing ring shall be formed and connected to the ground earthing through vertical risers. The earthing mat shall be common to both power and lighting installations.

2.9.11.11

A minimum of two spare earth rings will be provided in each floor of the building for earthing future building.

2.9.11.12

Each RCC steel column of the building will be interconnected to the floor-earthing grid in basement/ground floor.

For protective earthing separate conductor shall be used for flow of earth fault current as elaborated below:

TECHNICAL CONDITIONS OF CONTRACT (TCC)

Chapter - II : Scope of Works

2.9.11.13

Contractor shall carry out minor civil i.e. chipping of floor (where earth strip is to be laid on floor), removal of topsoil for laying earth strip in switchyard area etc.

2.9.11.14

It is the responsibility of contractor to provide skilled manpower for periodic maintenance after the initial commissioning till handing over the system to customer. During this period the activities are to be carried out such as checking the electrolyte & specific gravity of individual battery, topping up of electrolyte, cleaning etc.

2.9.12 INTEGRATED ELECTRICAL TESTING/COMMISSIONING

The brief scope of work under is defined as below, but not limited to the following. Contractor shall discuss & finalize testing procedure with BHEL Engineer In-Charge for the test to be conducted on Generator system. Drawing & documents shall be provided by BHEL at the time of testing. BHEL decision in this regard shall be final and binding on the contractor.

The contractor shall prepare all erection / commissioning log sheets and protocols / test certificates as per field quality plan/ Commissioning check list, get it signed by the concerned BHEL/customer engineer and submit the same to BHEL engineer as per his instruction.

Contractor shall maintain the charged and commissioned equipment till the same is taken over by customer.

Contractor's quoted rates for all concerned items shall include Integrated Testing as defined hereinafter.

2.9.12.1 GENERATOR SYSTEM TESTING

The following major works also shall be in the scope of the Contractor

1. Generator stator winding resistance and PI value measurement / check
2. Generator rotor winding resistance, impedance, IR value measurement before and after rotor insertion.
3. Generator Bushing HV test
4. Main exciter winding resistance, IR value measurement / check
5. PMG winding resistance, IR value measurement / check
6. Testing and commissioning of generator and exciter accessories viz., heaters, blowers, stroboscope, diodes, enclosure lighting, potential measurement of bearings (TE & EE) etc
7. Meggering during drying out of generator.

TECHNICAL CONDITIONS OF CONTRACT (TCC)

Chapter - II : Scope of Works

8. Meggering of generator bushing and its accessories. This test has to be conducted many times during erection and commissioning stages.
9. Assistance during dynamic testing of Generator and arrangement of instruments.

Contractor has to repeat any test free of cost, even if already conducted, whenever required to prove and check the healthiness of system before power flow, such test could be primary injection and primary injection in CTs., Insulation resistance of system / individual equipment, functional tests or any other tests as required by BHEL/ BHEL's client

2.9.13 ELECTRICAL ACTUATORS:

The scope of Testing and Commissioning of electrically operated actuators for valves, dampers, gates, soot blowers etc., will include meggering, providing loop wire on actuator terminal block, adjustments of mechanical/ electrical or electronic position transmitters, setting of limit/torque switches, cable checking, internal wiring checking, local/remote operation from MCC & MMI package (maxDNA system), replacement of limit/torque switches if required.

2.9.14 ELECTRICAL HOIST/ SINGLE GIRDER CRANE:

The scope of erection of hoist shall be in Mechanical agencies scope. The scope of work covers in this contract as follows:

1. The scope covers installation of trailing cable and its dressing, clamping from Isolation switch to Control box.
2. The scope covers installation of chain, support insulator, roller assembly and its supporting rope etc.
3. Installation of DSL and its accessories.
4. The testing, commissioning, handing over and clearance from statutory authority shall be in the scope electrical agency.
5. The requirement of scaffolding/ any other equipment for installation and commissioning of Hoist shall be in the scope of the electrical agency

Apart from the above any work related to the Hoist and Single Girder crane shall be covered in the scope of the electrical agency.

2.9.15

Equipments / instruments etc., under the above scope of erection and commissioning are generally dispatched from BHEL's manufacturing units / vendor's works at site well before start of erection. Sometimes, such dispatched materials may get stuck up with transporters/railways. The contractor shall provide support / manpower for necessary chase up for removal of such bottlenecks in transportation. Also, for smaller items, it could be necessary to depute his person to personally carry certain items from works to site. Requirement of such activities, which will be decided by BHEL

TECHNICAL CONDITIONS OF CONTRACT (TCC)

Chapter - II : Scope of Works

engineer and chase up activities, if required, shall be performed under authorization by BHEL. The above services shall be provided within the quoted rates.

TECHNICAL CONDITIONS OF CONTRACT (TCC)
Chapter – III : Facilities in the scope of Contractor/BHEL

Sl.No	Description	Scope / to be taken care by		Remarks
		BHEL	Bidder	
3.1	ESTABLISHMENT			
3.1.1	FOR CONSTRUCTION PURPOSE:			
a	Open space for office (as per availability)	Yes		Location will be finalized after joint survey with owner
b	Open space for storage (as per availability)	Yes		Location will be finalized after joint survey with owner
c	Construction of bidder's office, canteen and storage building including supply of materials and other services		Yes	
d	Bidder's all office equipments, office / store / canteen consumables		Yes	
e	Canteen facilities for the bidder's staff, supervisors and engineers etc		Yes	
f	Fire fighting equipments like buckets, extinguishers etc		Yes	
g	Fencing of storage area, office, canteen etc of the bidder		Yes	
3.1.2	FOR LIVING PURPOSES OF THE BIDDER			
a	Open space for labour colony (as per availability)	Yes		Location will be finalized after joint survey with owner.
b	Labour Colony with internal roads, sanitation, complying with statutory requirements		Yes	
3.2.0	ELECTRICITY			
3.2.1	Electricity For construction purposes of Voltage 415/440 V			Free
a	Single point source	Yes		At a distance of 1000 M from site (Distance is only estimated, it may vary upto an extent depending on site condition)
b	Further distribution including all materials, Energy Meter, Protection devices and its service		Yes	
c	Duties and deposits including statutory clearances if applicable		Yes	

TECHNICAL CONDITIONS OF CONTRACT (TCC)
Chapter – III : Facilities in the scope of Contractor/BHEL

Sl.No	Description PART I	Scope / to be taken care by		Remarks
		BHEL	Bidder	
3.2.2	Electricity for the office, stores, canteen etc of the bidder		Yes	Electricity charges shall be as per the tariff plan applicable in the site.
a	Single point source	Yes		At a distance of 1000 M from site (Distance is only estimated, it may vary upto an extent depending on site condition)
b	Further distribution including all materials, Energy Meter, Protection devices and its service		Yes	
c	Duties and deposits including statutory clearances if applicable		Yes	
3.2.3	Electricity for living accommodation of the bidder's staff, engineers, supervisors etc			Chargeable as per standard rates
a	Single point source		Yes	
b	Further distribution including all materials, Energy Meter, Protection devices and its service		Yes	
c	Duties and deposits including statutory clearances if applicable		Yes	
3.3.0	WATER SUPPLY			
3.3.1	For Construction purposes:			Free
a	Making the water available at single point		Yes	In case of inadequate supply / non-availability of construction water from customer, contractor shall have to arrange construction water at his own expenses.
b	Further distribution as per the requirement of work including supply of materials and execution		Yes	
3.3.2	<u>Water supply for bidder's office, stores, canteen etc</u>			Chargeable
a	Making the water available at single point		Yes	
b	Further distribution as per the requirement of work including supply of materials and execution		Yes	
3.3.3	<u>Water supply for Living Purpose</u>			

BHEL-PSWR:VOL-I-A-TECHNICAL BID

TECHNICAL CONDITIONS OF CONTRACT (TCC)
Chapter – III : Facilities in the scope of Contractor/BHEL

Sl.No	Description PART I	Scope / to be taken care by		Remarks
		BHEL	Bidder	
a	Making the water available at single point		Yes	
b	Further distribution as per the requirement of work including supply of materials and execution		Yes	
3.4.0	LIGHTING			
a	For construction work (supply of all the necessary materials) 1. At office/storage area 2. At the preassembly area 3. At the construction site /area		Yes	
b	For construction work (execution of the lighting work/ arrangements) 1. At office/storage area 2. At the preassembly area 3 At the construction site /area		Yes	
c	Providing the necessary consumables like bulbs, switches, etc during the course of project work		Yes	
d	Lighting for the living purposes of the bidder at the colony / quarters		Yes	
3.5.0	COMMUNICATION FACILITIES FOR SITE OPERATIONS OF THE BIDDER			
a	Telephone, fax, internet, intranet, e-mail etc		Yes	
3.6.0	COMPRESSED AIR wherever required for the work		Yes	
3.7.0	Demobilization of all the above facilities		Yes	
3.8.0	TRANSPORTATION			
a	For site personnel of the bidder		Yes	
b	For bidder's equipments and consumables (T&P, Consumables etc)		Yes	

TECHNICAL CONDITIONS OF CONTRACT (TCC)
Chapter – IV: T&Ps and MMEs to be deployed by Contractor

Tentative List of Major T&P and MME to be deployed by the Contractor

A. T&P FOR ELECTRICAL WORKS

SN	DESCRIPTION	<u>MINIMUM QUANTITY</u>
0109	HV TEST KIT AC, 0 –50 KV &DC, 0- 100 KV PREFERSBLY WITH DRY TYPE TRANSFORMER	1 NO. EACH
1022	SOLDERING IRON “SOLDRON” MAKE 25 WATT	2 NOS.
1403	MULTIMETRES	
04	A)DIGITAL 3 1/2 DIGIT OF REPUTED MAKE B) ANALOG MOTWANE MAKE	4 NOS. 3 NOS. 1NO.
05	INSULATION TESTER HAND OPERATED 250V/500V/1000 V RATED MAINS/BATTERY OPERATED	1 NO. EACH
06	INSULATION TESTER MAINS OPERATED 2500/5000V	1 NO.
07	PHASE SEQUENCE INDICATOR	1 NO.
08	TONG TESTER AC 5/10, 25/60/300 AMP RANGE REPUTED MAKE	1 NO. EACH
09	TONG TESTER DC 30/60/300 AMP	1 NO.
10	DC RESISTANCE METER	
11	STOP WATCH	1 NO.
12	TARPOLIN FIRE PROOF	As required
13	TELETALK 2 WIRE SYSTEM	6 SETS
14	TORQUE WRENCH (12-60Nm, 50-225 Nm)	1 NO EACH
15	FERRULE PRINTING MACHINE	1 NO
16	SILICON OIL FILTER MACHINE	1 NO.

TECHNICAL CONDITIONS OF CONTRACT (TCC)
Chapter – IV: T&Ps and MMEs to be deployed by Contractor

B. T&P FOR MECHANICAL WORK

SN	DESCRIPTION	<u>MINIMUM QUANTITY</u>
	HANDLING EQUIPMENTS	
1	TURN BUCKLES	AS PER REQMT
2	'D' SHACKLES	AS PER REQMT
3	STEEL WIRE ROPES	AS PER REQMT
4	MANILA ROPES	AS PER REQMT
5	CHAIN PULLEY BLOCK/TIRFUR	AS PER REQMT
	MAJOR T&P	
1	PIPE BENDING MACHINE – 2" SIZE	2 NOS
2	GRINDING MACHINE	2 NOS
3	DRILLING MACHINES 1/4", 1/2", 3/4" & 1"	1 NO. EACH
5	DYE SETS FOR THREADING UPTO 2" PIPE.	2 NOS
6	SPIRIT LEVEL	2 NOS.
7	TAP SETS FOR BOTH BSP AND MPT THREADS UPTO 1" EACH	1 SET EACH
9	WELDING GENERATORS	1 NO.
10	WELDING TRANSFORMER	1 NO.
12	MECHANICAL TOOL KIT FOR FITTERS	4 NOS.
13	ELECTRICIAN TOOL KIT	4 NOS.
14	CRIMPING TOOL UPTO ALL SIZE OF CABLES UNDER SCOPE OF WORK	4 NOS.
15	FLOOD LIGHT FITTINGS	2 NOS.
16	FIRE EXTINGUISHERS	3 NOS.
17	DISTRIBUTION BOARDS WITH POWER CABLE COMPLETE AS REQUIRED	1 SET
18	PAINTING BRUSH	AS PER REQMT.
19	FIRE PROOF TARPAULIN	AS PER REQMT.
20	SAFETY BELTS AND SAFETY HELMETS	AS PER REQMT

BHEL-PSWR:VOL-I-A-TECHNICAL BID

TECHNICAL CONDITIONS OF CONTRACT (TCC)
Chapter – IV: T&Ps and MMEs to be deployed by Contractor

SN	DESCRIPTION	<u>MINIMUM QUANTITY</u>
	HANDLING EQUIPMENTS	
21	24V A/C TRANSFORMER & HAND LAMPS	4 NOS.
22	MIG WELDING MACHINE WITH ACCESSORIES AIR COOL TYPE	NA for this project
23	CRIMPING TOOL HYDRAULIC UPTO 600 SQ.MM	1 NO.
24	TORQUE WRENCH SET	1 SET
25	HYDRAULIC JACKS 250T CAPACITY/100T	NA for this project
26	TUFFER CAPACITY 15T	2 NOS.
27	CHAIN PULLEY BLOCKS 5/10T	1 NO.EACH

Other than the aforesaid, one computer, printer and other necessary peripherals will have to be maintained by the contractor in his site office.

NOTE:

1. The list of instruments / equipments to be brought by the contractor as shown above sections-a and b are only indicative. any other instruments / equipments required for the execution of the work is to be necessarily arranged by the contractor within the quoted rates.
2. The testing/calibration instruments which are used to be duly calibrated in the interval prescribed by BHEL engineers from the reputed agencies decided by BHEL and test certificate to be furnished.
3. This above list is only indicative and neither exhaustive nor limiting. Quantities indicated above are only the minimum required. Contractor shall deploy all necessary t&p to meet the schedules & as prescribed by BHEL engineer and required for completion of work.

TECHNICAL CONDITIONS OF CONTRACT (TCC)
Chapter – V: T&Ps and MMEs to be deployed by BHEL on sharing basis

SN	DESCRIPTION & CAPACITY OF T&P	QUANTITY	PURPOSE
01	EOT CRANE IN TG HALL		FOR HANDLING AND ERECTION WITHIN TG HALL ON SHARING BASIS AS AVAILABLE AND SUBJECT TO THEIR ACCESSIBILITY AND APPROACHABILITY.

While all efforts will be made for amicable sharing of the above, non-availability of the above due to any reason shall not absolve the contractor of performing his responsibilities in time. The contractor shall undertake sufficient pre-planning and arrange his own handling/transport equipment as deemed necessary.

NOTE :

Above T&P will be provided for specific erection/commissioning activities wherein these equipment will be required. While taking delivery, contractor shall check for proper working of the equipment and the same shall be returned after the work is completed to BHEL stores in good working condition subject to normal wear and tear.

TECHNICAL CONDITIONS OF CONTRACT (TCC)

Chapter – VI: Time Schedule

6.1 TIME SCHEDULE & MOBILIZATION

6.1.1 INITIAL MOBILIZATION AND TENTATIVE SCHEDULE

Contractor shall reach site, make his site establishment and be ready to commence the work within **two weeks** from the date of fax Letter of Intent or as per directions of Construction Manager/ Project Manager of BHEL.

THE CONTRACTOR HAS TO SUBSEQUENTLY AUGMENT HIS RESOURCES IN SUCH A MANNER THAT THE ENTIRE WORK IS COMPLETED TO ACHIEVE THE FOLLOWING TENTATIVE SCHEDULE:

SN	Activity	Dates	
		U #3	U #4
01	Hydro Test	Jun-15	Oct-15
02	Boiler light up and ABO	Oct-15	Jan-16
03	Turbine box-up	Sept-15	Dec-15
04	Synchronization	Jan-16	Jun-16
05	Capacity Addition	Feb-16	Jul-16
06	Trial Operation	Apr-16	Sept-16
07	PG Test	Jul-16	Dec-16
08	Completion of Facilities	Aug-16	Jan-17

6.1.2

In order to meet above schedule and other intermediate targets/activities as set by BHEL Engineer In charge at site, to meet customer requirements/project schedule, contractor shall arrange all necessary resources and work force in consultation with BHEL engineer at site to under take works concurrently in all possible fronts as made available to contractor.

6.1.3

Contractor shall specifically note that there is likely to be some delay in supplies of materials / release of work fronts / other reasons. Contractor shall have to work round the clock on such critical activities as a part of catch up programme to

TECHNICAL CONDITIONS OF CONTRACT (TCC)

Chapter – VI: Time Schedule

meet the project requirement to the extent possible and shall also provide required resources as part of scope of work.

6.4 Contract Period

The total contract period for completion of entire work **will be 18 (EIGHTEEN) months from the date of start of** Erection of the first major equipment. Erection, Testing, Calibration and Commissioning of permanent equipments required for completion of system shall be completed within the time schedule given above.

The contract shall commence from the date of deployment of contractor's T&P, proper site setup and erection of first equipment. All the above three conditions are to be fulfilled (certified by BHEL engineer) for deciding the date of commencement of the contract.

.

The contractor shall complete all the work in the scope of this contract within the contract period

6.5 Definition of Work Completion

The contractor's scope of work under these specifications will be deemed to have been completed in all respect, only when all the activities are completed satisfactorily and so certified by BHEL site in charge. The decision of BHEL in this regard shall be final and binding on the contractor.

6.6 Schedule Compression

BHEL, owing to its commitment to their customer, may ask contractor to compress the total completion schedule by upto 10%. This will result in preponement of various milestones. For achieving the same, contractor shall plan his activities and mobilise additional resources accordingly to the satisfaction of BHEL engineer within the quoted rates.

TECHNICAL CONDITIONS OF CONTRACT (TCC)

Chapter-VII: Terms of Payment

The progressive payment for erection, testing and commissioning on accepted price of contract value for Electrical Package rates will be released as per the break up given hereinafter:

TERMS OF PAYMENT FOR ELECTRICAL WORKS

Sl. No.	Activity/Work Description	% of unit rate
I	PRO RATA PAYMENTS (85%)	
1.0	Cable tray and accessories	
1.1	Fabrication and fixing/welding/bolting in position	60%
1.2	Earthing of cable trays	10%
1.3	Tagging of cable trays (including touch up painting & cable tray numbering on sides)	8%
1.4	Covering of trays where ever envisaged	7%
	Total =	85%
2.0	Cable laying including earthing wires	
2.1	Laying of cables/Wires	45%
2.2	Glanding and termination (except HT terminations)	15%
2.3	Testing and charging	10%
2.5	Dressing and clamping	15%
	Total =	85%
3.0	Junction box/Push button station (local)	
3.1	Erection including fixing of terminal blocks where ever applicable	75%
3.2	Name plate fixing where ever applicable and labeling (inside and outside)	10%
	Total =	85%
4.0	Misc. Structural steel including cable tray supports, Canopies etc, Conduits, pipes etc	
4.1	Fabrication/Pre assembly	45%
4.2	Erection, Alignment, welding/bolting and if applicable chipping/grouting/painting	40%
	Total =	85%
5.0	DG sets/Switch Gears/MCC/PCC/Distribution Boards/Marshalling Box/Starter Units/ Dry Transformers / Electrical Hoists/ Panels/Cubicles/Desks/UPS/ Batteries/ Chargers/VFD/ LA assy/ NGT/ NGR/ SP/Miscellaneous Equipments/ etc	

TECHNICAL CONDITIONS OF CONTRACT (TCC)

Chapter-VII: Terms of Payment

5.1	Placement, Alignment and coupling/interconnection where ever applicable, erection of associated accessories etc	50%
5.2	Precommissioning checks and tests	10%
5.3	Charging, Loop testing and commissioning	15%
5.4	System commissioning	10%
		85%
6.0	Earthing/Lightning protection strips, Earthing pits	
6.1	Fabrication, erection, alignment, welding/bolting of earthing/lightning protection strips; earth pits completion	60%
6.2	Testing/commissioning	25%
		85%
7.0	LT /HT Bus Ducts	
7.1	Pre assembly of Bus Ducts and accessories, erection, alignment, bolting/welding etc complete with supporting structure	50%
7.2	Pre commissioning checks	20%
7.3	Testing, Charging and Painting (as applicable)	15%
		85%
8.0	Oil Filled Transformers (Generator, Station, UAT, Station Service etc)	
8.1	Placement on foundation and alignment	25%
8.2	Erection of associated auxiliaries/assemblies, oil filling, etc	25%
8.3	Dry out including oil filtration	15%
8.4	Precommissioning checks	10%
8.5	Testing, Charging and Painting (as applicable)	10%
		85%
9.0	Testing/Commissioning of Equipment (like motors, actuators, ESP trfr, misc equipments, etc) erected by other agencies	
9.1	Local testing	40%
9.2	Remote testing, Loop testing, and commissioning	40%
9.3	System commissioning	5%
		85%
10.0	Other items	
10.1	Rubber mats/ Display Boards/Miscellaneous items/etc : on installation	85%
10.2	Specialized Commissioning Services - on pro rata basis.	85%
10.3	Civil Works - Prorata on completion of actual work.	85%
10.4	Termination, HT Termination, Straight through jointing etc : on pro rata basis	85%

TECHNICAL CONDITIONS OF CONTRACT (TCC)

Chapter-VII: Terms of Payment

II	STAGE/MILESTONE PAYMENTS (15%)	
1	Boiler Light Up	1%
2	ABO	1%
3	Steam Blowing	0%
4	Safety Valve Floating	1%
5	Oil Flushing (TG)	0%
6	Barring Gear (TG)	0%
7	Rolling and Synchronisation	2%
8	Coal Firing	0%
9	Full Load	2%
10	Trial Operation of Unit	3%
11	Painting	0%
12	Area cleaning, temporary structures cutting/removal and return of scrap	1%
13	Punch List points/pending points liquidation	1%
14	Submission of 'As Built Drawings'	1%
15	Material Reconciliation	1%
16	Completion of Contractual Obligation	1%
	Total for Stage/Milestone Payments (15%)	15%

TECHNICAL CONDITIONS OF CONTRACT (TCC)

Chapter-VIII: Taxes and Other Duties

TAXES, DUTIES, LEVIES (Consolidated Rev 04 dated 14/05/2015)

8.1. For All types of works excepting works covered under sl no 8.2

8.1.1

The contractor shall pay all (save the specific exclusions as enumerated in this contract) taxes, fees, license charges, deposits, duties, tools, royalty, commissions or other charges which may be levied on the input goods & services consumed and output goods & services delivered in course of his operations in executing the contract. In case BHEL is forced to pay any of such taxes, BHEL shall have the right to recover the same from his bills or otherwise as deemed fit.

However, provisions regarding Service Tax and Value Added Tax (VAT) on output services and goods shall be as per following clauses.

8.1.2 Service Tax & Cess on Service Tax

Contractor's price/rates shall be exclusive of Service Tax and Cess on Services. In case, it becomes mandatory for the contractor under provisions of relevant act/law to collect the Service Tax & Cess from BHEL and pay the same to the concerned tax authorities, such applicable amount will be paid by BHEL at the prevailing Service Tax Rate (presently 12.36 %) on the admitted bill value.

Contractor shall submit to BHEL documentary evidence of Service Tax registration certificate specifying name of services covered under this contract. Contractor shall submit serially numbered Service Tax and Cess Invoice, signed by him or a person authorized by him in respect of taxable service provided, and shall contain the following, namely,

- 1. The name, address and the registration number of the contractor,**
- 2. The name and address of the party receiving taxable service,**
- 3. Description, classification and value of taxable service provided and,**
- 4. The service tax payable thereon.**

All the Four conditions shall be fulfilled in the invoice before release of service tax payment.

Wherever, more than one route/option are available for discharge of service tax liability under a particular service, (e.g. "works contract Service"), contractor shall obtain prior written consent from BHEL site before billing the amount towards Service Tax.

8.1.3 VAT (Sales Tax /WCT)

As regards Value Added Tax (VAT)/CST on transfer of property in goods involved in Works Contract (previously known as Works Contract Tax) applicable as per local laws, the price quoted by the contractor shall be inclusive of the same and in no case input or output VAT/CST will be reimbursed extra.

In any case the Contractor shall register himself with the respective Sales Tax authorities of the state and submit proof of such registration to BHEL along with the

TECHNICAL CONDITIONS OF CONTRACT (TCC)

Chapter-VIII: Taxes and Other Duties

first RA bill. Contractor will submit all the details of VAT/CST paid for the contract in the prescribed format of the respective state VAT laws. Also, the contractor will issue the tax Invoices to BHEL as per the Tax laws of respective state on monthly basis. Contractor shall also be required to furnish to BHEL necessary proof of VAT remittance on monthly basis.

Deduction of tax at source shall be made as per the provisions of law and is to be construed as an advance tax paid by the contractor and no reimbursement thereof will be made.

Further, if BHEL, at the instance of customer or otherwise adopts the specific route for discharging output VAT liability itself, benefit of the reduction in liability of the contractor will be passed on to BHEL.

In case, BHEL is forced to pay any VAT liability on behalf of contractor, the same will be recovered from contractor's bill or otherwise as deemed fit

8.2 'Enabling Works'

~~The contractor shall pay all (save the specific exclusions as enumerated in this contract) taxes, fees, license charges, deposits, duties, tools, royalty, commissions or other charges which may be levied on the input goods & services consumed and output goods & services delivered in course of his operations in executing the contract. In case BHEL is forced to pay any of such taxes, BHEL shall have the right to recover the same from his bills or otherwise as deemed fit. (~~
i.e. rates quoted by bidder shall be inclusive of Service Tax, VAT/WCT and all other taxes and duties)

~~However, Since the proposed work is in the nature of 'Works Contract service' as per Service tax law, Hence, For non corporate contractors being Individual, HUF, Proprietary Firm, Partnership Firm or Association of Persons (AOP), BHEL shall recover the applicable Service Tax under reverse charge mechanism from the contractor and remit the same with the Government as per the provisions of Law. Necessary advice/confirmation of remittance shall be issued to the contractor. The contractor shall not be eligible for any refund/reimbursement of such service tax from BHEL. It shall be the responsibility of the contractor to submit proper invoice giving all the requisite details as per Service Tax Law for the determination of the service tax liability of BHEL under reverse charge mechanism. BHEL reserves the right to determine such liability based on the invoice submitted by the contractor or otherwise independently and remittance of the same with the Government.~~

8.3 New Taxes/Levies

In case the Government imposes any new levy/tax on the output service/ goods/work after award of the contract, the same shall be reimbursed by BHEL at actual.

In case any new tax/levy/duty etc. becomes applicable after the date of Bidder's offer, the Bidder/Contractor must convey its impact on his price duly substantiated by

TECHNICAL CONDITIONS OF CONTRACT (TCC)

Chapter-VIII: Taxes and Other Duties

documentary evidence in support of the same **before opening of Price Bid**. Claim for any such impact after opening the Price Bid will not be considered by BHEL for reimbursement of tax or reassessment of offer.

No reimbursement/recovery on account of increase/reduction in the rate of taxes, levies, duties etc. on input goods/services/work shall be made. Such impact shall be taken care of by the Price Variation/Adjustment Clause (PVC) if any. In case PVC is not applicable for the contract, Bidder has to make his own assessment of the impact of future variation if any, in rates of taxes/duties/ levies etc. in his price bid.

8.4 BOCW Cess

The quoted rates shall be exclusive of the BOCW Cess which shall be paid extra by BHEL against Documentary evidence. However, the applicability of the BOCW Cess shall be got confirmed from BHEL in writing, before remitting such Cess/tax.

8.5 GST: As and when GST becomes applicable to this contract, the net differential (negative or positive) financial liability of the bidder to the Authorities (as compared to such liability prior to applicability of GST), if any, shall be to the account of BHEL. For this purpose, all available options under the GST shall be explored, and the decision of BHEL in this regard shall be final and binding on the bidder.

TECHNICAL CONDITIONS OF CONTRACT (TCC)
Chapter-IX : SPECIFIC INCLUSIONS

SPECIFIC INCLUSIONS

SI.No	Description	Scope / to be taken care by		Remarks
		BHEL	Bidder	
1	Lugs up to 4 sq mm size	-	Yes	
2	Lugs beyond 4 Sq. mm size	Yes		
3	Paint, primer and consumables		Yes	
4	LT cable straight through jointing Kits		Yes	
5	HT Termination Kits	-	-	Not applicable for this project.
6	Trefoil Clamps with hardware			NA
7	Identification tags PVC /Metals, sleeve and clamps with hardware. PVC ties, Ferrule, Buttons and tap		Yes	
8	Dry Nitrogen Cylinder for Transformer			NA

TECHNICAL CONDITIONS OF CONTRACT (TCC)

Chapter-X : SPECIFIC EXCLUSIONS

10.0 EXCLUSIONS

The following are specific exclusions from this work.

1. Erection of dampers, valves, electrical actuators, pneumatic actuators.
2. Erection of ESP rectifier transformer, electrical heaters, rapping motors, mechanical interlock.
3. Erection of HT/LT motors (except those specified herein)
4. Erection, testing and commissioning of elevators and DG sets.
5. HT/LT Switchgear.
6. Generator Erection.
7. Supply of cable trays

The aforesaid exclusions should not be construed as exhaustive. They are meant for general guideline. BHEL reserves the right to include or exclude any item which is required for completing the job as per rates indicated in rate schedule. Contractor should carry out all such jobs as per the instructions of BHEL engineer.

TECHNICAL CONDITIONS OF CONTRACT (TCC)

Chapter-XI: GENERAL

TECHNICAL DETAILS, BILL OF QUANTITIES & DRAWINGS

1. GENERAL INFORMATION

1. CONTACT PRESSURE

FOLLOWING TORQUE ARE NORMALLY RECOMMENDED FOR VARIOUS BOLTS.

BOLT SIZE	RECOMMENDED TORQUE	TORQUE CAPTY.	SPANNER
M10	0.85 TO 1.3 NM (20-30 Ft- lb)	0.85 TO 1.3 NM	
M12	1.3 TO 1.7 NM (30-40 FT-lb)	0.85 TO 4.3NM	
M16	1.7 TO 2.1NM (40 –50 FT-lb)	0.85 TO 4.3NM	
M20	2.1 TO 2.5 NM (50 –60 FT-lb)	0.85 TO 4.3NM	

Alternatively tightening the nut till Belleville washer becomes flats. Then unscrew the nut by 1/8th turn. Exact method and extent of tightening shall be done as per instructions of BHEL site engineer / as per equipment supplier's recommendation.







Note: - Considering the layout of the bus ducts as mentioned above for interconnection between the transformer and Generator it is not possible to segregate the quantity of structural support materials for individual area, hence the total quantity is mentioned.

Flexible joints, seal off bushings, rubber bellows, CT and their wiring, conduits/GI pipes breather tapping etc, etc are accessories and form a part of the system.

3. DIGITAL AUTOMATIC VOLTAGE REGULATOR PANELS FOR BRUSHLESS EXCITATION SYSTEM

SI.No	DESCRIPTION	Quantity per unit
1	Digital Automatic Voltage Regulator (panel consist of Regulation, Thyristor and Field suppression cubicle), Total weight - 1.5 MT (Approx). DAVR console assembled or loose components are to be mounted on Unit Control Desk.	1 Nos

TECHNICAL CONDITIONS OF CONTRACT (TCC)
Chapter-XII ELECTRICAL AND INSTRUMENTATION

	<table border="1" style="width:100%; border-collapse: collapse;"> <tr> <td style="width:20%;">OWNER</td> <td>NTPC-SAIL POWER COMPANY PVT. LTD.</td> </tr> <tr> <td>PROJECT</td> <td></td> </tr> </table>	OWNER	NTPC-SAIL POWER COMPANY PVT. LTD.	PROJECT											
OWNER	NTPC-SAIL POWER COMPANY PVT. LTD.														
PROJECT															
	<table border="1" style="width:100%; border-collapse: collapse;"> <tr> <td style="width:20%;">CONSULTANTS</td> <td>BLACK & VEATCH, USA</td> </tr> </table>	CONSULTANTS	BLACK & VEATCH, USA												
CONSULTANTS	BLACK & VEATCH, USA														
	<table border="1" style="width:100%; border-collapse: collapse;"> <tr> <td style="width:20%; text-align: center;">  </td> <td> BHARAT HEAVY ELECTRICALS LIMITED POWER SECTOR PROJECT ENGINEERING MANAGEMENT NOIDA, UTTAR PRADESH, INDIA </td> </tr> </table>		BHARAT HEAVY ELECTRICALS LIMITED POWER SECTOR PROJECT ENGINEERING MANAGEMENT NOIDA, UTTAR PRADESH, INDIA												
	BHARAT HEAVY ELECTRICALS LIMITED POWER SECTOR PROJECT ENGINEERING MANAGEMENT NOIDA, UTTAR PRADESH, INDIA														
	<table border="1" style="width:100%; border-collapse: collapse;"> <tr> <td style="width:20%; text-align: center;">  </td> <td> VATCO ELEC-POWER PRIVATE LIMITED NAVI MUMBAI, INDIA </td> </tr> </table>		VATCO ELEC-POWER PRIVATE LIMITED NAVI MUMBAI, INDIA												
	VATCO ELEC-POWER PRIVATE LIMITED NAVI MUMBAI, INDIA														
TITLE:-	<table border="1" style="width:100%; border-collapse: collapse;"> <tr> <th style="width:10%;">DEPT CODE</th> <th style="width:40%;">NAME</th> <th style="width:10%;">SIGN</th> <th style="width:10%;">DATE</th> </tr> <tr> <td rowspan="3" style="text-align: center; vertical-align: middle;">E</td> <td>DESN</td> <td>-</td> <td>-</td> </tr> <tr> <td>CHKD</td> <td>M. ANAND</td> <td>21.03.07</td> </tr> <tr> <td>APPD</td> <td>S. JITENDRA</td> <td>21.03.07</td> </tr> </table>	DEPT CODE	NAME	SIGN	DATE	E	DESN	-	-	CHKD	M. ANAND	21.03.07	APPD	S. JITENDRA	21.03.07
DEPT CODE	NAME	SIGN	DATE												
E	DESN	-	-												
	CHKD	M. ANAND	21.03.07												
	APPD	S. JITENDRA	21.03.07												
	<table border="1" style="width:100%; border-collapse: collapse;"> <tr> <td style="width:60%;">VATCO DRG.NO.</td> <td style="width:40%; text-align: center;">REV. 0</td> </tr> </table>	VATCO DRG.NO.	REV. 0												
VATCO DRG.NO.	REV. 0														
BHEL DRG. NO:															
PE-DG-239-507-E051	<table border="1" style="width:100%; border-collapse: collapse;"> <tr> <td style="width:10%;">SCALE</td> <td style="width:10%;">SHEET NO</td> <td style="width:10%;">1</td> </tr> <tr> <td>NTS</td> <td>NO OF SHEET</td> <td>11</td> </tr> </table>	SCALE	SHEET NO	1	NTS	NO OF SHEET	11								
SCALE	SHEET NO	1													
NTS	NO OF SHEET	11													

TECHNICAL CONDITIONS OF CONTRACT (TCC)
Chapter-XII ELECTRICAL AND INSTRUMENTATION

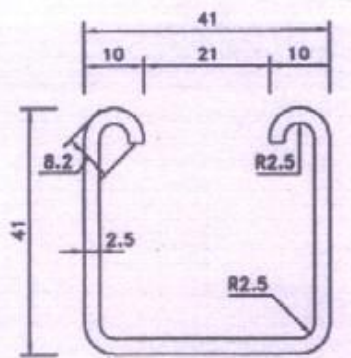

SINGLE CHANNEL SCI

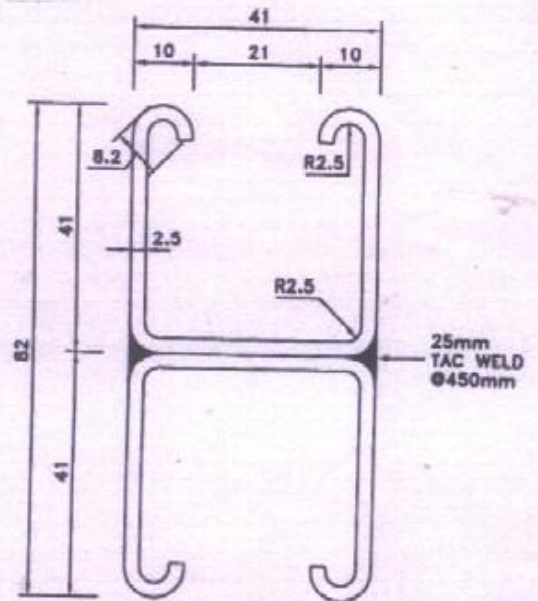

DOUBLE CHANNEL DCI

TWO LENGTHS OF SINGLE CHANNEL
SPOT WELDED BACK TO BACK
AT 75MM C/C

- NOTES :**
1. ALL DIMENSIONS ARE IN mm
 2. MATERIAL : 2.5 MM THK MS SHEET HOT ROLLED AS PER IS : 1079
 3. FINISH : HOT DIP GALVANISED AS PER IS 2629
 4. TOLERANCE ON THICKNESS IS AS PER IS 1852
 5. PROFILE TOLERANCE +/- 0.5 MM

TITLE :-
TYPICAL DETAILS OF BOLTABLE TYPE
CABLE TRAY SUPPORT MATERIAL &
ACCESSORIES

VATCO DRG. NO. :

BHEL DRG. NO. :

PE-DG-239-507-E051

SHEET :- 2 OF 11

REV. :- 0

TECHNICAL CONDITIONS OF CONTRACT (TCC)
Chapter-XII ELECTRICAL AND INSTRUMENTATION

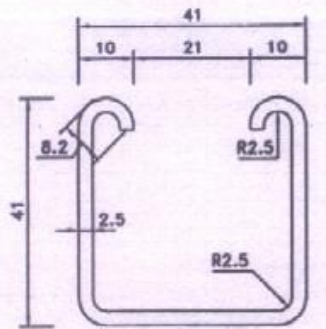

SINGLE CHANNEL SC1

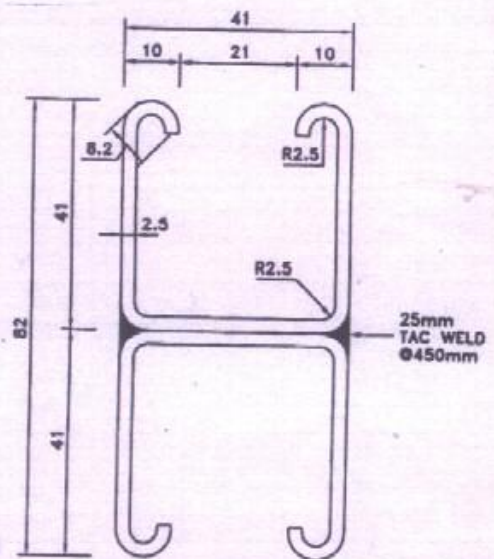

DOUBLE CHANNEL DC1

**TWO LENGTHS OF SINGLE CHANNEL
 SPOT WELDED BACK TO BACK
 AT 75MM C/C**

- NOTES :**
1. ALL DIMENSIONS ARE IN mm
 2. MATERIAL : 2.5 MM THK MS SHEET HOT ROLLED AS PER IS : 1079
 3. FINISH : HOT DIP GALVANISED AS PER IS 2629
 4. TOLERANCE ON THICKNESS IS AS PER IS 1852
 5. PROFILE TOLERANCE +/- 0.5 MM

<p>TITLE :- TYPICAL DETAILS OF BOLTABLE TYPE CABLE TRAY SUPPORT MATERIAL & ACCESSORIES</p>	<p>VATCO DRG. NO. : [REDACTED]</p> <p>BHEL DRG. NO. : PE-DG-239-507-E051</p> <p>SHEET :- 2 OF 11 REV. :- 0</p>
---	--

TECHNICAL CONDITIONS OF CONTRACT (TCC)
Chapter-XII ELECTRICAL AND INSTRUMENTATION

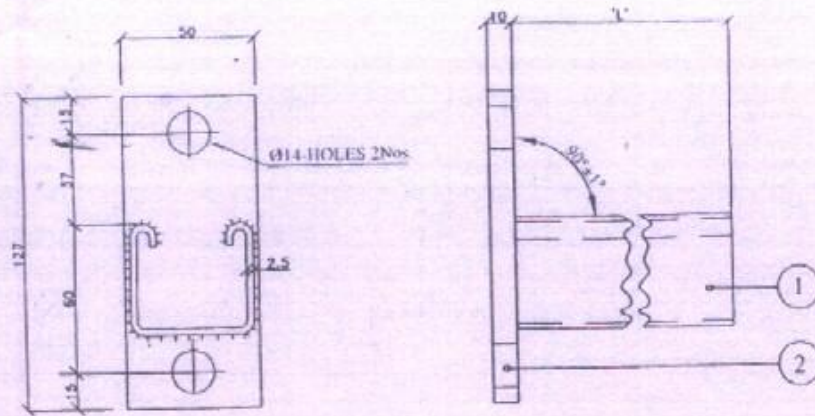

CANTILEVER ARMS

TRAY WIDTH IN MM	CANTILEVER ARM LENGTH [L] IN MM
150	170
300	320
450	470
600	620

- NOTES :**
1. ALL DIMENSIONS ARE IN mm
 2. MATERIAL : 2.5 MM THK MS SHEET HOT ROLLED AS PER IS : 1079
 3. FINISH : HOT DIP GALVANISED AS PER IS 2629
 4. TOLERANCE ON THICKNESS IS AS PER IS 1852
 5. PROFILE TOLERANCE +/- 0.5 MM

TITLE :- TYPICAL DETAILS OF BOLTABLE TYPE CABLE TRAY SUPPORT MATERIAL & ACCESSORIES	VATCO DRG. NO. : [REDACTED]
	BHEL DRG. NO. : PE-DG-239-507 E051
	SHEET :- 3 OF 11
	REV. :- 0

TECHNICAL CONDITIONS OF CONTRACT (TCC)
Chapter-XII ELECTRICAL AND INSTRUMENTATION

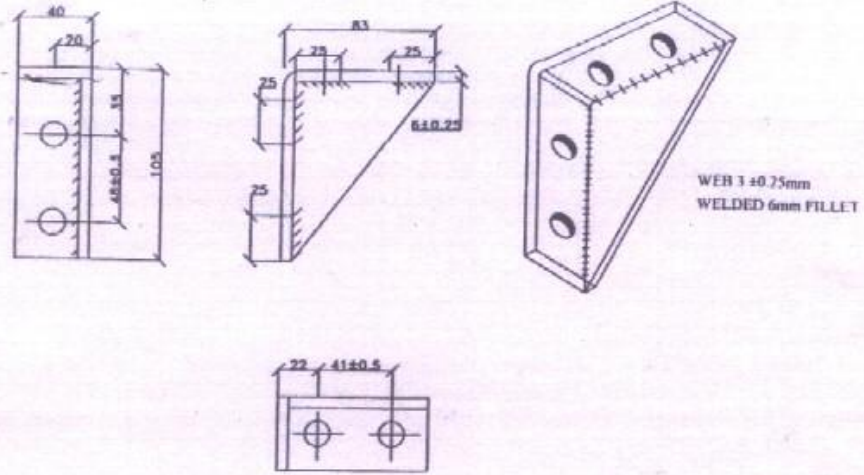

90° ANGLE FITTING H/L

NOTES :

1. ALL DIMENSIONS ARE IN mm.
2. ALL FABRICATION TOLERANCES ±1.0 mm
3. MATERIAL :MILD STEEL AS PER IS-2062
4. FINISH : HOT DIP GALVANISED AS PER IS:2629
5. TOLERANCE ON THICKNESS AS PER IS:1852

TITLE :- TYPICAL DETAILS OF BOLTABLE TYPE CABLE TRAY SUPPORT MATERIAL & ACCESSORIES	VATCO DRG. NO. : [REDACTED] BHEL DRG. NO. : PE-DG-239-507-E051 SHEET :- 4 OF 11 REV. :- 0
--	---

TECHNICAL CONDITIONS OF CONTRACT (TCC)
Chapter-XII ELECTRICAL AND INSTRUMENTATION

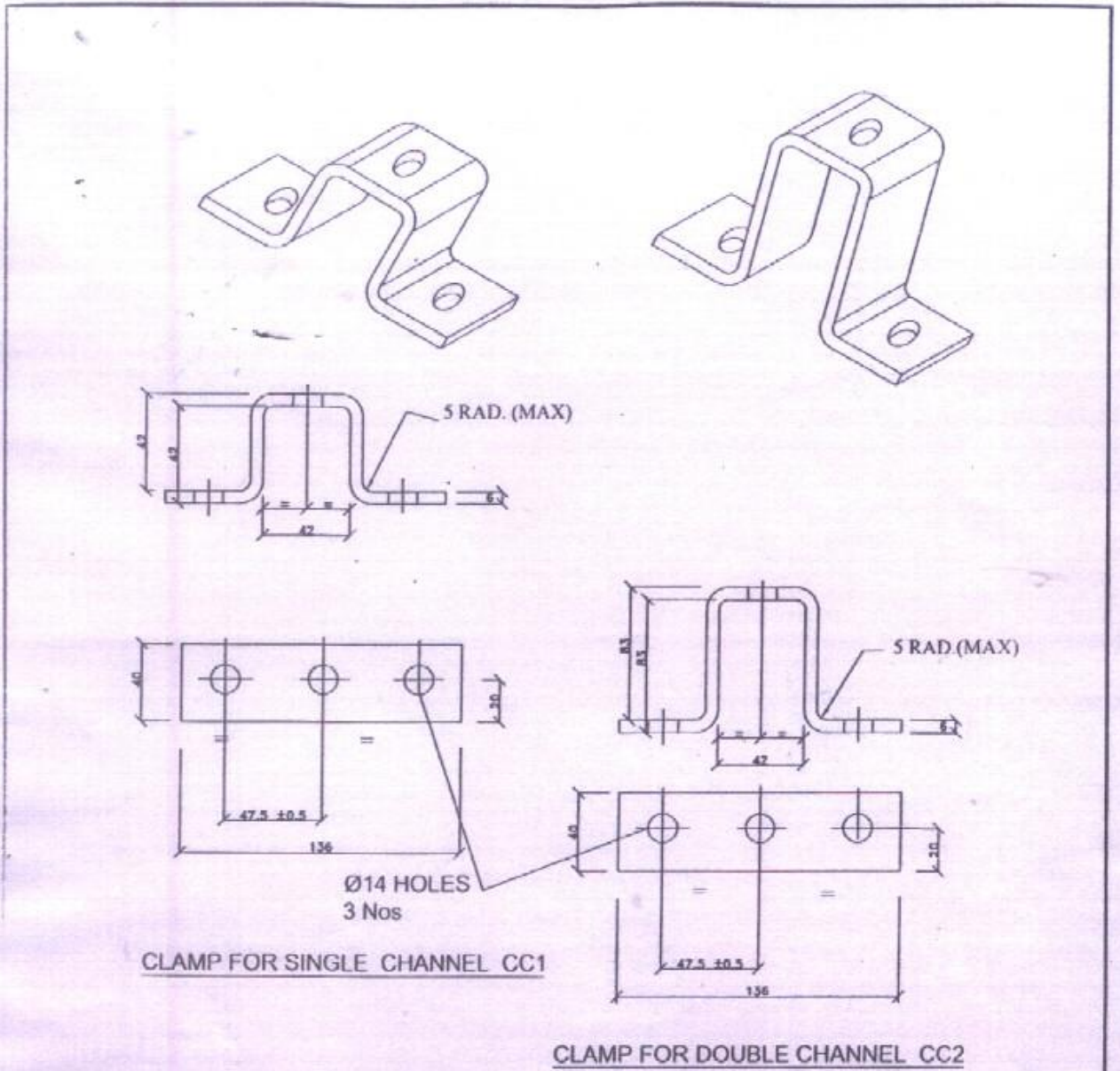

CLAMP FOR SINGLE CHANNEL CC1

CLAMP FOR DOUBLE CHANNEL CC2

- NOTES**
1. ALL DIMENSIONS ARE IN mm.
 2. ALL FABRICATION TOLERANCES ± 1.0 mm
 3. MATERIAL :MILD STEEL AS PER IS-2062
 4. FINISH : HOT DIP GALVANISED AS PER IS:2629
 5. TOLERANCE ON THICKNESS AS PER IS:1852

<p>TITLE :- TYPICAL DETAILS OF BOLTABLE TYPE CABLE TRAY SUPPORT MATERIAL & ACCESSORIES</p>	<p>VATCO DRG. NO. : [REDACTED]</p> <p>BHEL DRG. NO. : PE-DG-239-507-E051</p> <p>SHEET :- 5 OF 11 REV. :- 0</p>
---	--

TECHNICAL CONDITIONS OF CONTRACT (TCC)
Chapter-XII ELECTRICAL AND INSTRUMENTATION

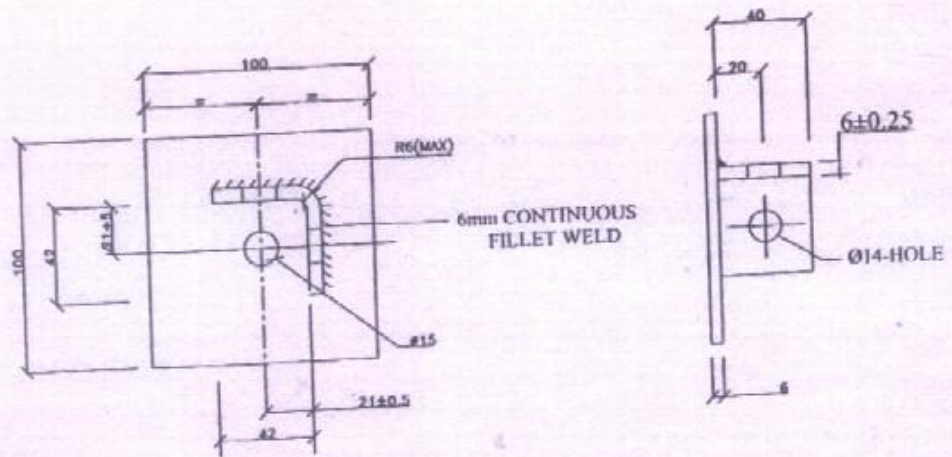
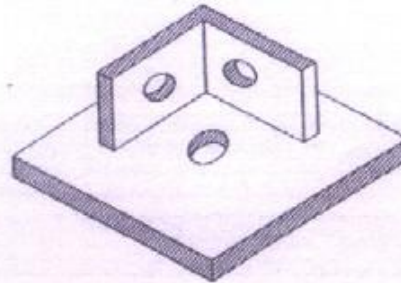

BASE PLATE FOR SINGLE CHANNEL BP1

NOTE

1. ALL DIMENSIONS ARE IN MM.
2. ALL FABRICATION TOLERANCES ± 1.0 mm.
3. MATERIAL : MILD STEEL AS PER IS-2062
4. FINISH : HOT DIP GALVANISED AS PER IS:2629
5. TOLERANCE ON THICKNESS AS PER IS:1852

TITLE :-
TYPICAL DETAILS OF BOLTABLE TYPE
CABLE TRAY SUPPORT MATERIAL &
ACCESSORIES

VATCO DRG. NO. :

BHEL DRG. NO. :

PE-DG-239-507-E051

SHEET :- 6 OF 11

REV. :- 0

TECHNICAL CONDITIONS OF CONTRACT (TCC)
Chapter-XII ELECTRICAL AND INSTRUMENTATION

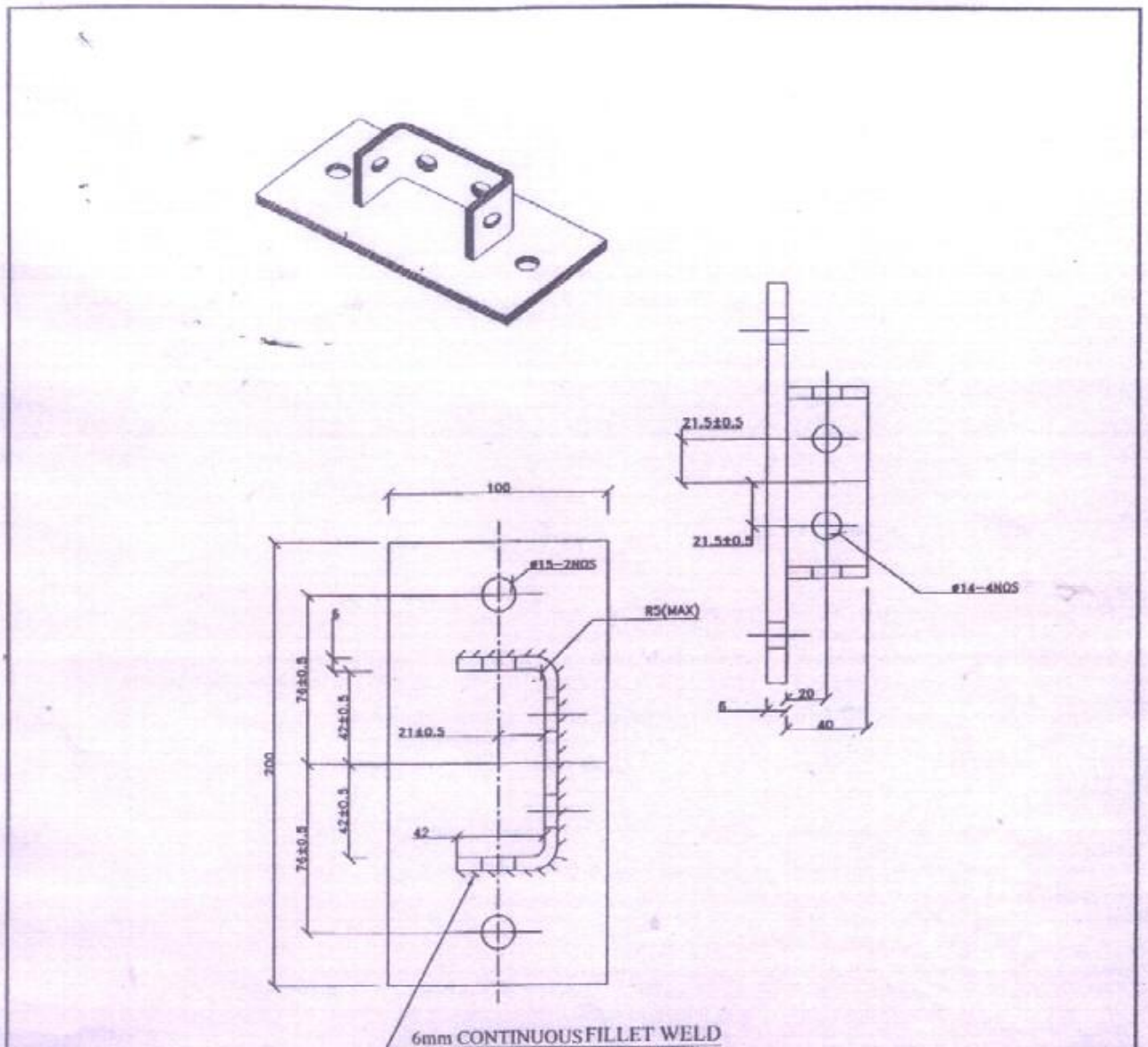

BASE PLATE FOR DOUBLE CHANNEL BP2

NOTES

1. ALL DIMENSIONS ARE IN MM
2. ALL FABRICATION TOLERANCES $\pm 1.0\text{mm}$
3. MATERIAL :MILD STEEL AS PER IS-2062
4. FINISH : HOT DIP GALVANISED AS PER IS:2629
5. TOLERANCE ON THICKNESS AS PER IS:1852

TITLE :- TYPICAL DETAILS OF BOLTABLE TYPE CABLE TRAY SUPPORT MATERIAL & ACCESSORIES	VATCO DRG. NO. : [REDACTED]
	BHEL DRG. NO. : PE-DG-239-507-E051
	SHEET :- 7 OF 11 REV. :- 0
	[REDACTED]

TECHNICAL CONDITIONS OF CONTRACT (TCC)
Chapter-XII ELECTRICAL AND INSTRUMENTATION

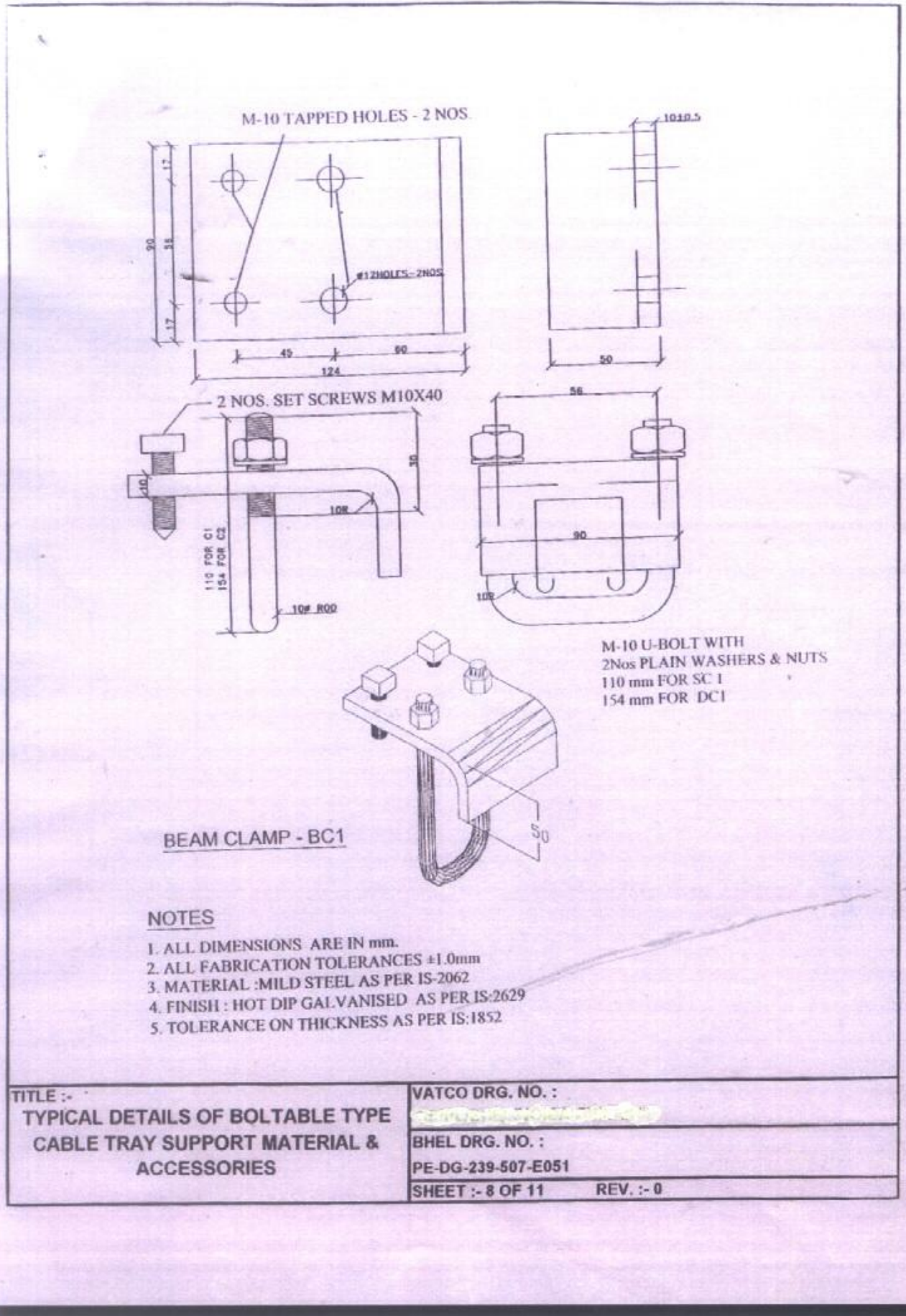

TECHNICAL CONDITIONS OF CONTRACT (TCC)
Chapter-XII ELECTRICAL AND INSTRUMENTATION

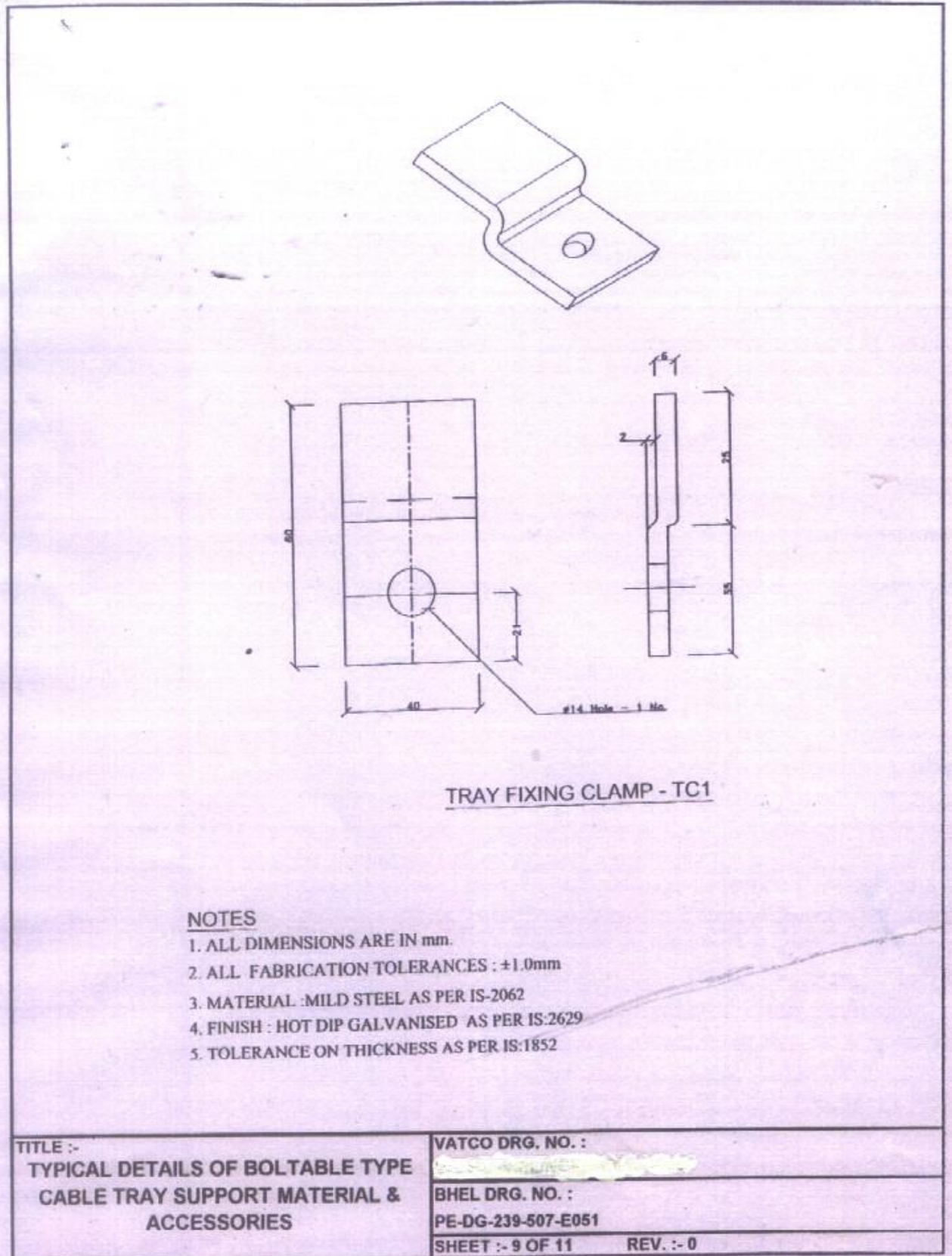

TECHNICAL CONDITIONS OF CONTRACT (TCC)
Chapter-XII ELECTRICAL AND INSTRUMENTATION

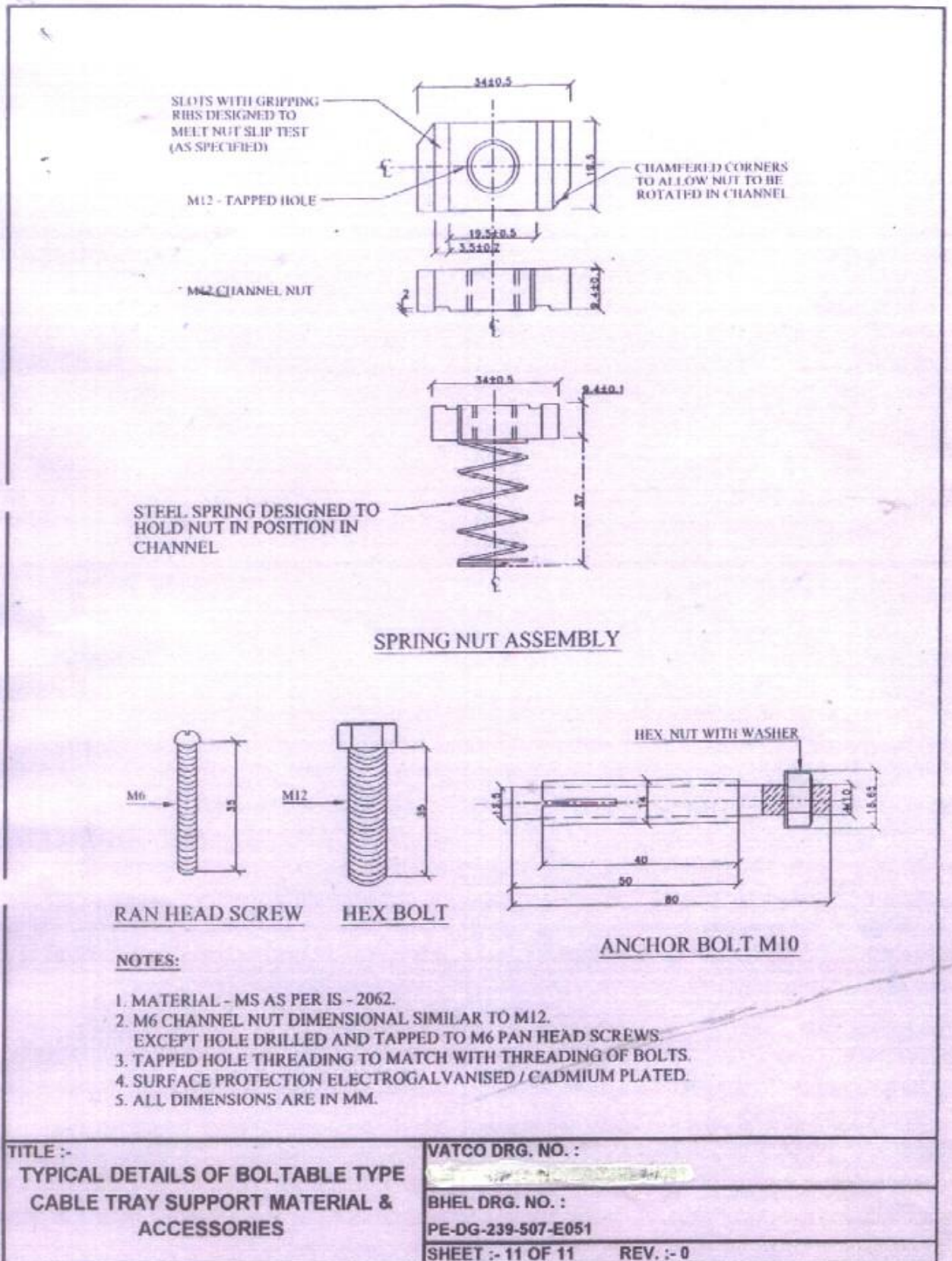

TECHNICAL CONDITIONS OF CONTRACT (TCC)
Chapter-XII ELECTRICAL AND INSTRUMENTATION

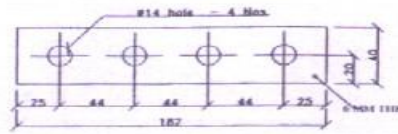

FLAT PLATE STRAIGHT FITTING PF2

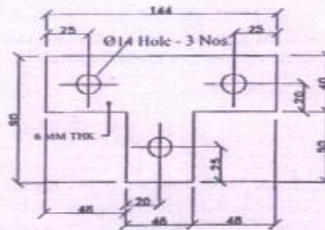

FLAT PLATE TEE FITTING PF1

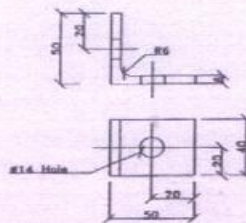

90° ANGLE FITTING LA1

NOTES

1. ALL DIMENSIONS ARE IN mm.
2. ALL FABRICATION TOLERANCES ± 1.0 mm
3. MATERIAL : MILD STEEL AS PER IS-2062
4. FINISH : HOT DIP GALVANISED AS PER IS:2629

TITLE :- TYPICAL DETAILS OF BOLTABLE TYPE CABLE TRAY SUPPORT MATERIAL & ACCESSORIES	VATCO DRG. NO. : BHEL DRG. NO. : PE-DG-239-507-E051 SHEET :- 10 OF 11 REV. :- 0
--	--

TECHNICAL CONDITIONS OF CONTRACT (TCC)

Chapter-XIII: Schedule of items & Quantities and Factor for deriving Item Rate from the accepted Lumpsum Price.

This Chapter consists of Part-B: *Schedule of items & Quantities and Factor for deriving Item Rate from the accepted Lumpsum Price.*

Note: This Chapter-XI is uploaded as file titled 'Chapter XI BOQ and *Factor*'-1501

Calculation Excel Sheet for arriving at item rates is uploaded as file titled 'Excel-Sheet-1501'. This document is only for the purpose of calculation/information and same does not form part of Contract